

# beko

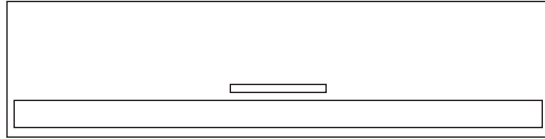

## User's Manual Air Conditioner

30925  
31225  
31825



**Döküman Numarası**  
5401376266 Rev.:

## Please read this manual first!

Dear Customer,



We want you to get the best yield from the product that is produced in modern facilities and passed through rigorous quality control processes. For this reason, carefully read the entire instruction manual carefully before using the product and save it as a reference. If you hand over the product to someone else, give it a guide.

## The user guide helps you to use the product quickly and safely.

- Read the instruction manual before installing and operating the product.
- Be absolutely sure to follow safety instructions.
- Keep it in a place where you can easily access the manual as you may need it later.
- Please note that this manual may also apply to other models.  
The differences between the models are clearly indicated in the guide.
- This product is a heating device designed for heating and cooling purposes.

## Symbols and explanations

The user guide contains the following symbols:

-  Important information or useful tips about using it.
-  Warning against dangerous situations in terms of life and property.
-  Warning against electric shock.



This product is produced in a modern way, respecting nature without harming nature.

It is suitable for AEEE Regulation.



# TABLE OF CONTENTS

This manual may contain images or content different from the model you purchased.

This manual is subject to revision by the manufacturer.

<b>SAFETY INSTRUCTIONS .....</b>	<b>3</b>
IMPORTANT SAFETY INSTRUCTIONS .....	4
Disposal of Your Old Appliance.....	8
<b>OPERATION .....</b>	<b>9</b>
Notes for Operation.....	9
Parts and Functions.....	9
Wireless Remote Control.....	10
<b>TECHNICAL SPECIFICATIONS .....</b>	<b>13</b>
Restarting the Air Conditioner Automatically.....	14
Using the Mode Function.....	14
Using the Jet Mode Function.....	16
Using the Fan Speed Function.....	16
Using the Air Flow Direction Function.....	17
Setting the On/Off Timer.....	18
Using the Sleep Function (Optional).....	18
Using the Energy Display Function (Optional).....	19
Using the Light Off Function (Optional).....	19
Using the Soft Air Function (Optional).....	19
Using the Energy Control Function (Optional).....	20
Using Special Functions.....	20
<b>MAINTENANCE.....</b>	<b>22</b>
Clean the Air Filter.....	24
Clean the 3M and Triple Filter (Optional).....	25
<b>TROUBLESHOOTING.....</b>	<b>26</b>

# SAFETY INSTRUCTIONS

The following safety guidelines are intended to prevent unforeseen risks or damage from unsafe or incorrect operation of the appliance.

The guidelines are separated into 'WARNING' and 'CAUTION' as described below.

 This symbol is displayed to indicate matters and operations that can cause risk. Read the part with this symbol carefully and follow the instructions in order to avoid risk.

 **WARNING**

This indicates that the failure to follow the instructions can cause serious injury or death.

 **CAUTION**

This indicates that the failure to follow the instructions can cause the minor injury or damage to the product.

The following symbols are displayed on indoor and outdoor units.

 This symbol indicates that this appliance uses a flammable refrigerant. If the refrigerant is leaked and exposure to an external ignition source, there is a risk of fire.

 This symbol indicates that the Operation Manual should be read carefully.

 This symbol indicates that a service personnel should be handling this equipment with reference to the Installation Manual.

 This symbol indicates that information is available such as the Operating Manual or Installation Manual.

# IMPORTANT SAFETY INSTRUCTIONS

## WARNING

**To reduce the risk of explosion, fire, death, electric shock, injury or scalding to persons when using this product, follow basic precautions, including the following:**

### **Children in the Household**

This appliance is not intended for use by persons (including children) with reduced physical, sensory or mental capabilities, or lack of experience and knowledge, unless they have been given supervision or instruction concerning use of the appliance by a person responsible for their safety. Children should be supervised to ensure that they do not play with the appliance.

### **Installation**

- Do not install the air conditioner on an unstable surface or in a place where there is danger of it falling.
- Contact an authorized service center when installing or relocating the air conditioner.
- Install the panel and the cover of the control box safely.
- Do not install the air conditioner in a place where flammable liquids or gases such as gasoline, propane, paint thinner, etc., are stored.
- Make sure that the pipe and the power cable connecting the indoor and outdoor units are not pulled too tight when installing the air conditioner.
- Use standard circuit breaker and fuse that conform to the rating of the air conditioner.
- Do not input air or gas into the system except with the specific refrigerant.
- Use non-flammable gas (nitrogen) to check for leak and to purge air; using compressed air or flammable gas may cause fire or explosion.
- The indoor/outdoor wiring connections must be secured tightly, and the cable should be routed properly so that there is no force pulling the cable from the connection terminals. Improper or loose connections can cause heat generation or fire.
- Install dedicated electric outlet and circuit breaker before using the air conditioner.
- Do not connect the ground wire to a gas pipe, a lightning rod, or a telephone ground wire.
- Keep any required ventilation openings clear of obstruction.

## **Operation**

- Be sure to use only those parts listed in the service parts list. Never attempt to modify the equipment.
- Make sure that children do not climb on or hit the outdoor unit.
- Dispose of the batteries in a place where there is no danger of fire.
- Use only the refrigerant specified on the air conditioner label.
- Cut off the power supply if there is any noise, smell, or smoke coming from the air conditioner.
- Do not leave flammable substances such as gasoline, benzene, or thinner near the air conditioner.
- Contact an authorized service center when the air conditioner is submerged by flood waters.
- Do not use the air conditioner for an extended period of time in a small place without proper ventilation.
- In the event of a gas leak (such as Freon, propane gas, LP gas, etc.) ventilate sufficiently before using the air conditioner again.
- To clean the interior, contact an authorized service center or dealer. Using harsh detergents may cause corrosion or damage to the unit.
- Be sure to ventilate sufficiently when the air conditioner and a heating appliance such as a heater are used simultaneously.
- Do not block the inlet or outlet of air flow.
- Do not insert hands or other objects through the air inlet or outlet while the air conditioner is operating.
- Make sure that the power cable is neither dirty, loose, nor broken.
- Never touch, operate, or repair the air conditioner with wet hands.
- Do not place any objects on the power cable.
- Do not place a heater or other heating appliances near the power cable.
- Do not modify or extend the power cable. Scratches or peeling insulation on the power cables may result in fire or electric shock, and should be replaced.
- Cut off the power supply immediately in the event of a blackout or a thunderstorm.
- Take care to ensure that power cable could not be pulled out or damaged during operation.
- Do not touch refrigerant pipe, water pipe and any internal parts while the unit is operating or immediately after operation.

## **Maintenance**

- Before cleaning or performing maintenance, disconnect the power supply and wait until the fan stops.
- Do not clean the appliance by spraying water directly onto the product.

## Technical Safety

- Installation or repairs made by unauthorized persons can pose hazards to you and others.
- Any person who is involved with working on or breaking into a refrigerant circuit should hold a current valid certificate from an industry-accredited assessment authority, which authorizes their competence to handle refrigerants safely in accordance with an industry recognized assessment specification.
- Servicing shall only be performed as recommended by the equipment manufacturer. Maintenance and repair requiring the assistance of other skilled personnel shall be carried out under the supervision of the person competent in the use of flammable refrigerants.
- The information contained in the manual is intended for use by a qualified service technician who is familiar with the safety procedures and equipped with the proper tools and test instruments.
- Failure to read and follow all instructions in this manual can result in equipment malfunction, property damage, personal injury and/or death.
- The appliance shall be installed in accordance with national wiring regulations.
- When the power cord is to be replaced, the replacement work shall be performed by authorized personnel using only genuine replacement parts.
- This appliance must be properly grounded to minimize risk of electric shock.
- Do not cut or remove the grounding prong from the power plug.
- Attaching the earth wire to the power outlet cover screw does not ground the appliance unless the cover screw is metal, uninsulated, and the power outlet is grounded through house wiring.
- If you have any doubt whether the air conditioner is properly grounded, have the power outlet and circuit checked by a qualified electrician.
- The refrigerant and insulation blowing gas used in the appliance require special disposal procedures. Consult a service agent or a similarly qualified person before disposing of them.
- If the supply cord is damaged, it must be replaced by the manufacturer or its service agents or similarly qualified person in order to avoid a hazard.
- The appliance shall be stored in a well-ventilated area where the room size corresponds to the room area as specified for operation.
- The appliance shall be stored in a room without continuously operating open flames (for example an operating gas appliance) and ignition sources (for example an operating electric heater).
- The appliance shall be stored so as to prevent mechanical damage from occurring.

## CAUTION

To reduce the risk of minor injury to persons, malfunction, or damage to the product or property when using this product, follow basic precautions, including the following:

### Installation

- Do not install the air conditioner in an area where it is directly exposed to sea wind (salt spray).
- Install the drain hose properly for the smooth drainage of water condensation.
- Exercise caution when unpacking or installing the air conditioner.
- Do not touch the leaking refrigerant during installation or repair.
- Transport the air conditioner with two or more people or use a forklift.
- Install the outdoor unit such that it is protected from direct sunlight. Do not place the indoor unit in a place where it is directly exposed to sunlight via the windows.
- Safely dispose of packing materials such as screws, nails or batteries using proper packaging after installation or repair.
- Install the air conditioner in a place where the noise from the outdoor unit or the exhaust fumes will not inconvenience the neighbors. Failure to do so may result in conflict with the neighbors.

### Operation

- Remove the batteries if the remote control is not to be used for an extended period of time.
- Make sure that the filter is installed before operating the air conditioner.
- Be sure to check if there is a refrigerant leak after installing or repairing the air conditioner.
- Do not place any object on the air conditioner.
- Never mix different types of batteries, or old and new batteries for the remote control.
- Do not let the air conditioner run for a long time when humidity is very high or when a door or a window has been left open.



- Stop using the remote control if there is a fluid leak in the battery. If your clothes or skin are exposed to the leaking battery fluid, wash off with clean water.
- Do not expose people, animals, or plants to the cold or hot wind from the air conditioner for extended periods of time.
- If the leaking battery fluid has been swallowed, rinse the inside of the mouth thoroughly and consult a doctor.
- Do not drink the water drained from the air conditioner.
- Do not use the product for special purposes, such as preserving foods, works of art, and etc. It is an air conditioner for consumer purposes, not a precision refrigeration system. There is risk of damage or loss of property.
- Do not recharge or disassemble the batteries.

### **Maintenance**

- Never touch the metal parts of the air conditioner when removing the air filter.
- Use a sturdy stool or ladder when cleaning, maintaining, or repairing the air conditioner at a height.
- Never use strong cleaning agents or solvents when cleaning the air conditioner or spray water. Use a smooth cloth.



### **Compliance with AEEE Regulation and disposal of waste product**

**i** Disposal of oil and coolant gas and dismantling of other parts must be carried out in accordance with the relevant local and national regulations.

**i** Do not remove the system yourself. Disassembly of the system and handling of coolant gas, oil or other parts should be performed by the Authorized Service according to the relevant local and national regulations.

This product does not contain harmful and prohibited substances specified in the «Regulation on the Control of Waste Electrical and Electronic Goods» issued by the T.C. Ministry of Environment and Urban Planning. This product is made from recycled and reusable high quality parts and materials. For this reason, do not dispose the product with household or other waste at the end of its service life. Take it to a collection point for recycling of electrical and electronic equipment. Ask these local points to local management in your area. Help by recycling used products to conserve environment and natural resources. Cut off the power plug for children's safety before disposing of the product.

# OPERATION

## Notes for Operation

### Suggestion for Energy Saving

- Do not over-cool the space. This may be harmful for your health and may consume more electricity.
- Block sunlight with blinds or curtains while you are operating the air conditioner.
- Keep doors or windows closed tightly while you are operating the air conditioner.
- Adjust the direction of the air flow vertically or horizontally to circulate indoor air.
- Speed up the fan to cool or warm indoor air quickly, within a short period of time.
- Open windows regularly for ventilation. The indoor air quality may deteriorate if the air conditioner is used for long durations.
- Clean the air filter once every 2 weeks. Dust and impurities collected in the air filter may block the air flow or reduce the unit performance.

## Parts and Functions

### Indoor Unit

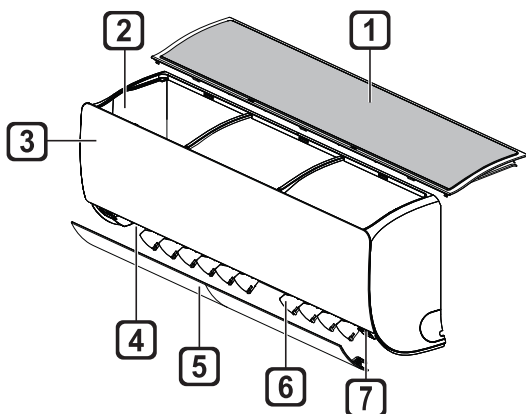

- ① Air Filter
- ② Air Intake
- ③ Front Cover
- ④ Air Outlet
- ⑤ Air Deflector (Horizontal Vane)
- ⑥ Air Deflector (Vertical Louver)
- ⑦ On/Off Button

### Outdoor Unit

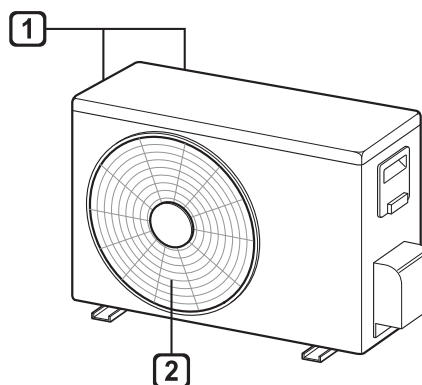

- ① Air Intake Vents
- ② Air Outlet Vents

### NOTE

- The number and location of operation lamps may vary according to the model of the air conditioner.
- The feature may be changed according to the type of model.

# Wireless Remote Control

## Inserting Batteries

If the display screen of the remote control begins to fade, replace the batteries. Insert AAA (1.5 V) batteries before using the remote control.

- 1 Remove the battery cover.

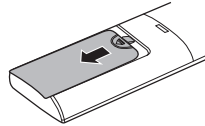

- 2 Insert the new batteries and make sure that the + and - terminals of the batteries are installed correctly.

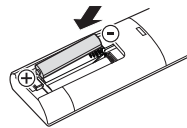

## Installing the Remote Control Holder

To protect the remote control, install the holder where there is no direct sunlight.

- 1 Choose a safe and easily accessible location.
- 2 Fix the holder by fastening 2 screws firmly with a screwdriver.

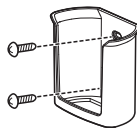

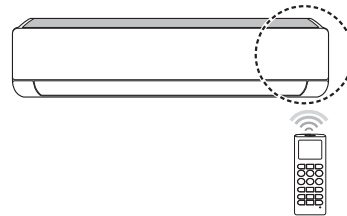

## Operating Method

Point the remote control towards the signal receiver at the right side of the air conditioner to operate it.



## NOTE

- The remote control may operate other electronic devices if it is directed towards them. Make sure to point the remote control towards the air conditioner signal receiver.
- For proper operation, use a soft cloth to clean the signal transmitter and receiver.
- In case of a function not provided in the product, no buzzer sound occurs from the product when a button for such function on the remote control is pressed except for Air Flow Direction (  ), Energy Display (  ), Air Purification function (  ).

## Setting the Current Time

- 1 Insert batteries.
  - The icon below blinks at the bottom of the display screen.



- 2 Press  or  button to select the minutes.
- 3 Press  button to finish.

### NOTE

- The On/Off Timer is available after setting the current time.

## Using the °C/°F Conversion Function (Optional)

This function changes unit between °C and °F

- Press and hold  button about 5 seconds.

## Operating the Air Conditioner without the Remote Control

You can use the  button of the indoor unit to operate the air conditioner when the remote control is unavailable.

- 1 Open the front cover (Type2) or horizontal vane (Type1).
- 2 Press the  button.

### Type1

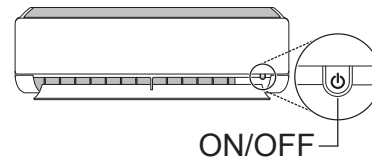

### Type2

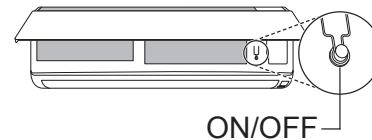

### NOTE

- The stepping motor may be broken, if the horizontal vane opens rapidly.
- The fan speed is set to high.
- The feature may be changed according to the type of model.
- The temperature cannot be altered when using this emergency  button.
- For cooling-only models, the temperature is set to 22 °C
- For cooling & heating models, the temperature is set from 22 °C to 24 °C

# Using the remote control

You can operate the air conditioner more conveniently with the remote control. You will find the buttons for the additional functions under the cover of the remote control.

## Wireless remote control

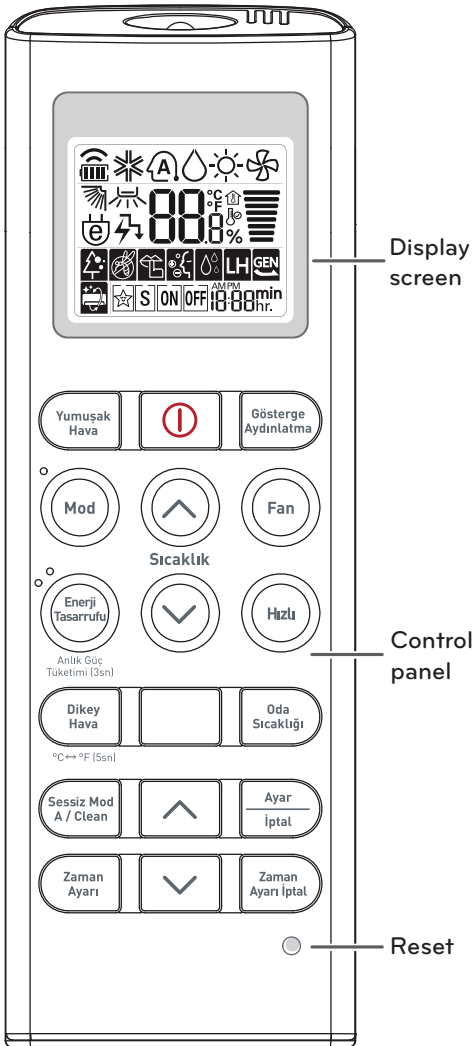

Control panel	Display screen	Description
Sessiz Mod A / Clean		<b>Function button</b> To reduce noise from outdoor units. To remove moisture generated inside the indoor unit.
Ayar iptal	-	<b>Set/Cancel button</b> To set/cancel the special functions and timer.
Yumuşak Hava		<b>Soft air function</b> To adjust the air flow to defle wind.
Sıcaklık	88°C	<b>Temperature setting buttons</b> To adjust the desired room temperature in cooling, heating or auto changeover mode.
	-	<b>On-Off button</b> To turn on/off the air conditioner.
Fan		<b>Fan speed function</b> To adjust the fan speed.
Mod	    	<b>Mode function</b> To select the cooling mode. To select the heating mode. To select the dehumidification mode. To select the fan mode. To select the auto changeover/auto operation mode.
Hızlı	Po	<b>Jet mode function</b> To change room temperature quickly.
Dikey Hava	 °C °F	<b>Air flow direction function</b> To adjust the air flow direction vertically.
Gösterge Aydınlatma	-	<b>Light off function</b> To set the brightness of the display on the indoor unit.
	-	<b>Reset button</b> To initialize the remote control settings.
Enerji Tasarrufu	88%	<b>Energy control function</b> To bring the effect of the power saving.
Oda Sıcaklığı		<b>Room Temperature</b> To display the room temperature.
Zaman Ayarı	ON/OFF	<b>Setting on/off timer</b> To turn on/off air conditioner automatically at desired time.
 	-	To adjust time.
Zaman Ayarı iptal	-	<b>Cancelling the timer setting</b> To cancel the timer settings.

\* Some functions may not be supported, depending on the model.

# Technical Specifications

MODEL			30925	31225	31825
Capacity	Cooling	Btu/h	9000	12000	18000
		W	2638	3517	5275
	Heating	Btu/h	11260	13648	19790
		W	3300	4000	5800
P Design	Cooling	kW	2,50	3,50	5,00
	Heating (-10°C)	kW	3,50	3,50	3,90
Power Input	Cooling	W	656	1080	1562
	Heating	W	800	1050	1611
EER/COP*		W/W	3,81 / 4,13	3,24 / 3,81	3,20 / 3,60
SEER/SCOP**		W/W	7,0 / 4,0	6,6 / 4,0	7,0 / 4,3
Energy Label	Cooling / Heating	-	A++ / A+	A++ / A+	A++ / A+
Annual Energy Consumption	Cooling / Heating	kWh/yil	125 / 875	186 / 875	250 / 1270
Dehumidification Rate	Cooling	lt/h	1,1	1,3	1,8
Power Supply		V, Ø, Hz	220-240, 1, 50	220-240, 1, 50	220-240, 1, 50
Running Current (Nom/Maks)	Cooling	A	3,4 / 6,0	4,7 / 6,0	7,3 / 9,0
	Heating	A	3,7 / 7,0	4,7 / 7,0	7,1 / 9,5
Circuit Breaker		A	15	15	20
Sound Pressure (Sleep)		dBA	19	19	31
Sound Power	Indoor Unit	dBA	59	59	60
	Outdoor Unit	dBA	65	65	65
Net Weight	Indoor Unit	kg	8,70	8,70	11,70
	Outdoor Unit	kg	25,10	25,10	35,20

- i** Technical specifications may be changed without notice to improve the quality of the product.
- i** The shapes in the guide are schematic and may not be in perfect harmony with the product.
- i** The markings on the product or other printed the values declared in the documents are determined in the laboratory environment are the values obtained. These values are based on product usage and ambient conditions change.

\* EER and COP values are the energy consumption class, and TS EN 14511 measurement standards.

Cooling: Indoor temperature 27°C KT, 19°C YT / Outdoor Environment: 35°C KT, 24°C YT

Heating: Indoor temperature 20°C KT, 15°C YT / Outdoor Environment: 7°C KT, 6°C YT



\*\* SEER and SCOP values are the energy consumption class, and TS EN 14511 measurement standards.

- i** Catalog data are energy consumption values given according to standard test results. Actual energy consumption may vary depending on the conditions in which the devices are used.

# Restarting the Air Conditioner Automatically

When the air conditioner is turned on again after a power failure, this function restores the previous settings.

## Disabling Auto Restart

- 1 Open the front cover (Type2) or horizontal vane (Type1).
- 2 Press the  button and hold it for 6 seconds, then the unit will beep twice and the lamp will blink twice 4 times.
  - To re-enable the function, press the  button and hold it for 6 seconds. The unit will beep twice and the lamp will blink 4 times.

### Type1

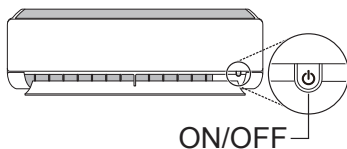

### Type2

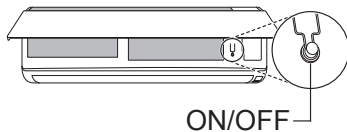

## NOTE



- The feature may be changed according to the type of model.
- If you press and hold the  button for 3 – 5 seconds, instead of 6 seconds, the unit will switch to the test operation. In the test operation, the unit blows out strong cooling air for 18 minutes and then returns to factory default settings.

# Using the Mode Function

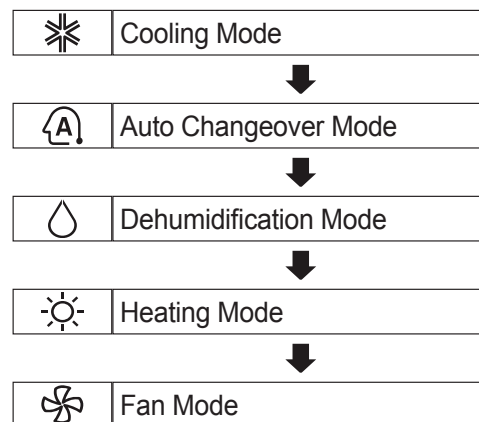
This function allows you to select the desired function.







## Cooling Mode

- 1 Turn the appliance on.
- 2 Press **MODE** button repeatedly to select the Cooling Mode.
  -  is displayed on the display screen.
- 3 Press  or  button to set the desired temperature.

## Auto Changeover Mode



### Cooling & Heating Model

This mode changes the mode automatically to maintain the set temperature at  $\pm 2$  °C

- 1 Turn the appliance on.
- 2 Press  button repeatedly to select the Auto Changeover Mode.
  -  is displayed on the display screen.
- 3 Press  or  button to set the desired temperature.
- 4 Press  button to adjust the fan speed.

### Dehumidification Mode





This mode removes excess moisture from a highly humid environment or during the rainy season, in order to prevent mildew from setting in. This mode adjusts the room temperature and the fan speed automatically to maintain the optimal level of humidity.

- 1 Turn the appliance on.
- 2 Press  button repeatedly to select the Dehumidification Mode.
  -  is displayed on the display screen.

#### NOTE

- In this mode you cannot adjust the room temperature, it is adjusted automatically.
- The room temperature is not displayed on the display screen.

## Heating Mode



- 1 Turn the appliance on.
- 2 Press  button repeatedly to select the Heating Mode.
  -  is displayed on the display screen.
- 3 Press  or  button to set the desired temperature.

#### NOTE

-  will be displayed on the indoor unit when defrosting is operating.
- Furthermore, this indication will be displayed on the indoor unit:
  - When preheating is operating.
  - When the room temperature has been reached to the set temperature.

## Fan Mode

This mode only circulates the indoor air without changing the room temperature.

- 1 Turn the appliance on.
- 2 Press  button repeatedly to select the Fan Mode.
  -  is displayed on the display screen.
- 3 Press  button to adjust the fan speed.





## Using the Jet Mode Function





### Changing Room Temperature Quickly

This function allows you to cool indoor air quickly during the summer or warm it quickly during winter.

- Cooling & Heating model : The Jet Mode function is available with Cooling, Heating and Dehumidification Mode.
- Cooling Only model : The Jet Mode function is available with Cooling, Dehumidification, Fan, Auto Operation Mode and Air Purification function.

- 1 Turn the appliance on.
- 2 Press  button repeatedly to select the desired mode.
  - P is displayed on the display screen.
- 3 Press  button.
  - P is displayed on the display screen.





#### NOTE

- Jet Heating Mode is not available on some models.
- In Jet Cooling Mode, strong air blows out for 30 minutes.
- After 30 minutes later, setting temperature is maintaining 18 °C  
If you want to change the temperature, Press  or  button to set the desired temperature.
- In Jet Heating Mode, strong air blows out for 30 minutes.
- After 30 minutes later, setting temperature is maintaining 30 °C  
If you want to change the temperature, Press  or  button to set the desired temperature.
- This function may operate differently from the remote control display.

## Using the Fan Speed Function

### Adjusting the Fan Speed

- Press  button repeatedly to adjust the fan speed.

Display Screen	Speed
	High
	Medium - High
	Medium
	Medium - Low
	Low
-	Natural Wind

#### NOTE

- The fan speed of Natural Wind adjusts automatically.





- The fan speed icons are displayed on some indoor units.



- Indoor unit display is displayed only 5 seconds and return to the setting temperature on some models.

## Using the Air Flow Direction Function

This function adjusts the direction of the air flow vertically (horizontally).

- Press  button repeatedly and select the desired direction.
  - Select  to adjust the direction of the air flow automatically.

### NOTE

- Adjusting the air flow direction horizontally may not be supported, depending on the model.
- Adjusting the air deflector arbitrarily may cause product failure.
- If you restart the air conditioner, it starts to operate with the previously set direction of air flow, so the air deflector may not match the icon displayed on the remote control. When this occurs, press  button to adjust the direction of the air flow again.
- This function may operate differently from the remote control display.





## Setting the On/Off Timer

This function sets the air conditioner to turn on/off automatically at desired time.

### Setting the On Timer

- 1 Press  button repeatedly.
  - The icon below blinks at the bottom of the display screen.



- 2 Press  or  button to select the minutes.
- 3 Press  button to finish.
  - After setting the timer, current time and  icon are displayed on the display screen indicating that the desired time is set.

### Canceling the On Timer

- 1 Press  button repeatedly.
  - The icon below blinks at the bottom of the display screen.







- 2 Press  button to cancel the setting.

## Setting the Off Timer

- 1 Press  button repeatedly.
  - The icon below blinks at the bottom of the display screen.



- 2 Press  or  button to select the minutes.
- 3 Press  button to finish.
  - After setting the timer, current time and  icon are displayed on the display screen indicating that the desired time is set.

### NOTE

- This function is disabled when you set Simple Timer.

## Canceling the Off Timer

- 1 Press  button repeatedly.
  - The icon below blinks at the bottom of the display screen.



- 2 Press  button to cancel the setting.

## Canceling the Timer Setting





- Press  button to cancel all timer settings.

## Using the Sleep Function (Optional)

This function turns off the air conditioner automatically when you go to sleep.

- 1 Turn the appliance on.
- 2 Press  button repeatedly.
  - The icon below blinks at the bottom of the display screen.



- 3 Press  or  button to select the hour (up to 7 hours).
- 4 Press  button to finish.
  -  is displayed on the display screen.



### NOTE

-  is displayed on some indoor units.
- Indoor unit display is displayed from 1H to 7H which is displayed only 5 seconds and then return to the setting temperature.
- In the Cooling and Dehumidification Mode, the temperature increases by 1 °C after 30 minutes and additional 1 °C after another 30 minutes for a more comfortable sleep.
- The temperature increases up to 2 °C from the preset temperature.
- Although the remark for fan speed on the display screen may be changed, the fan speed is adjusted automatically.



## Using the Energy Display Function (Optional)

This function displays the amount of electricity generated on the indoor display as the product operates.

### Display the Current Energy Usage

- 1 Turn the appliance on.
- 2 Press  button and hold it about 3 seconds.
  - The instantaneous power consumption ( or  <sup>kW</sup>/<sub>kWh</sub>) is displayed for a while on some indoor units.

### Display the Cumulative Energy Usage (Optional)

- 1 Turn the appliance on.
- 2 Press  button and hold it about 3 seconds twice.
  - The cumulative power consumption ( <sup>kW</sup>/<sub>kWh</sub>) is displayed for a while on some indoor units.

#### NOTE

- It is not displayed on the wireless remote control.
- **kW** refers to instantaneous power consumption.
- **kWh** refers to cumulative power consumption.
- If it is more than 99 kWh, which is the range of expression, maintain it as 99 kWh.
- Power off resets its value.
- Display wattage under 10 kW(h) with 0.1 kW(h) unit, and display one over 10 kW(h) with 1 kW(h) unit.
- The actual power may differ from the power displayed.

## Using the Light Off Function (Optional)

### Display Screen Brightness

You can set the brightness of the indoor unit display screen.

- Press  button.



#### NOTE

- Turn on/off the Display screen.





## Using the Soft Air Function (Optional)

### Soft Vane Operation

This function conveniently sets the vane to a preset position to deflect the supply air away from blowing directly onto the occupants in the room.

- 1 Turn the appliance on.
- 2 Press  button repeatedly and select the desired direction.
  -  or  is displayed on the display screen.





#### NOTE

-  or  is displayed on some indoor units.
- This function is disabled when you press  or  button.
- This function is disabled and auto swing of vertical direction is set up when you press `__logo__PAC_Flow1_G__` button.
- When this function is off, the horizontal vane operates automatically depending on the set mode.



## Using the Energy Control Function (Optional)

- 1 Turn the appliance on.
- 2 Press  button.
  - Press  button repeatedly to select each step.







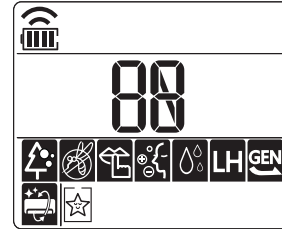

### NOTE

- 1 step : The power Input is decreased by 20 % compared to rated power input.
  - 80 % is displayed on the display screen.
- 2 step : The power Input is decreased by 40 % compared to rated power input.
  - 60 % is displayed on the display screen.
- 3 step (Optional) : The power Input is decreased by 60 % compared to rated power input.
  - 40 % is displayed on the display screen.
- L (1 step), LL (2 step) is displayed on some indoor units.
- This function is available with Cooling Mode.
- Capacity may decrease when Energy Control mode is selected.
- Desired temperature is displayed about 5 seconds if you press ,  or  button.
- Room temperature is displayed about 5 seconds if you press  button.

## Using Special Functions

- 1 Turn the appliance on.
- 2 Press  button repeatedly to select the desired function.
- 3 Press  button to finish.





Display Screen	Description
	To purify the air by removing particles that enters the indoor unit.
	To reduce noise from outdoor units.
	To keep your skin moisturized by generating ion clusters.
 Po	To lower indoor humidity quickly.
	To maintain a minimum room temperature and prevent objects in the room from freezing.
	To scare away a mosquito.
	To remove moisture generated inside the indoor unit.
 SL	To make a comfortable sleeping environment.

### NOTE

- Some functions may not be supported, depending on the model.
- Some functions may operate differently from the remote control display.

## Canceling Special Functions



- 1 Press  button repeatedly to select the desired function.
- 2 Press  button to cancel the function.

## Using the Silent Function

This function prevents potential claims by neighbors, reducing noise from outdoor units.

-  is displayed on the display screen.

### NOTE

- This function is disabled when you press  or  or  button.
- This function is available with Cooling, Heating, Auto Changeover, Auto Operation Mode.

## Using the Auto Clean Function

In the Cooling and Dehumidification Mode, moisture is generated inside the indoor unit. This function removes such moisture.

-  is displayed on the display screen.

### NOTE

- Some functions cannot be used while the Auto Clean function is in operation.
- If you turn off the unit, the fan continues to run for 30 minutes and cleans the inside of the indoor unit.

# MAINTENANCE

## **⚠ WARNING**

- Before cleaning or performing maintenance, disconnect the power supply and wait until the fan stops.

If the air conditioner will not be used for an extended period of time, dry the air conditioner to maintain it in best condition. Clean the product regularly to maintain optimal performance and to prevent possible breakdown.

- Dry the air conditioner in Fan mode for 3 to 4 hours and disconnect the power. There may be internal damage if moisture is left in its components.
- Before using the air conditioner again, dry the inner components of the air conditioner in Fan mode for 3 to 4 hours. This will help to remove the odor generated from moisture.

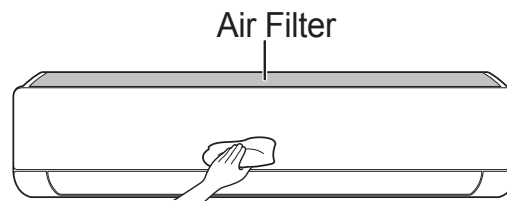

- The feature may be changed according to the type of model.

Type	Description	Interval
<b>Air filter</b>	Clean with a vacuum or hand wash.	2 weeks
<b>Triple filter</b>	Clean with a vacuum or brush.	Every 3 months
<b>3M filter</b>	Clean with a vacuum or brush.	Every 6 months
<b>Ionizer (Optional)</b>	Use dry cotton bud to remove any dust.	Every 6 months
<b>Indoor unit</b>	Clean the Indoor unit surface by using a soft, dry cloth.	Regularly
	Have a professional clean the condensate drain pan.	Once a year
	Have a professional clean the condensate drain pipe.	Every 4 months
	Replace the remote control batteries.	Once a year
<b>Outdoor unit</b>	Have a professional clean the heat exchanger coils and the panel vents. (Consult with technician.)	Once a year
	Have a professional clean the fan.	Once a year
	Have a professional clean the condensate drain pan.	Once a year
	Have a professional verify that all the fan assembly is firmly tightened.	Once a year
	Clean the electric components with air.	Once a year

## NOTE

- Never use water that is higher than 40 °C when you clean the filters. It may cause deformation or discoloration.
- Never use volatile substances when you clean the filters. They may damage the surface of the product.
- Do not wash the 3M filter with water, because the filter can be damaged (Optional).
- Do not wash the Triple filter with water, because the filter can be damaged (Optional).



# Clean the Air Filter

Clean the air filters once every 2 weeks, or more, if necessary.

## NOTE

- The air filter can be broken when it is bent.
- When the air filter is not assembled correctly, dust and other substances can enter into the indoor unit.

## Type1

If you look at the indoor unit from above it, can assemble the top filter easily.

- 1 Turn off the power to the unit.
- 2 Hold the knobs of the air filter, lift it up slightly.

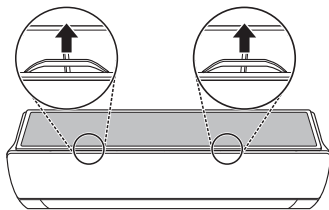

- 3 Remove it from the indoor unit.

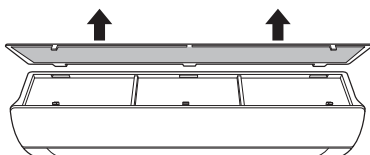

- 4 Clean the filter with a vacuum cleaner or with lukewarm water with neutral detergent.
- 5 Dry the filter in the shade.
- 6 Insert the hooks of the air filter into the front cover.

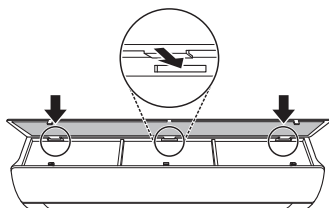

- 7 Push down hooks to assemble the air filter.

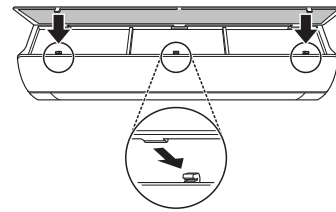

- 8 Check the side of the front cover for correct assembly of the air filter.

## Type2

- 1 Turn off the power to the unit.
- 2 Open the front cover.
  - Lift up both sides of the cover slightly.
- 3 Hold the knobs of the air filters, pull them down slightly and remove them from the indoor unit.

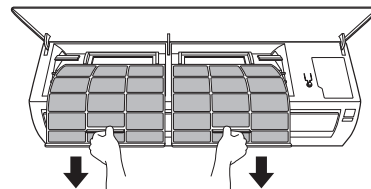

- 4 Clean the filters with a vacuum cleaner or with lukewarm water with neutral detergent.
- 5 Dry the filters in the shade.
- 6 Insert the hooks of the air filters into the front cover.

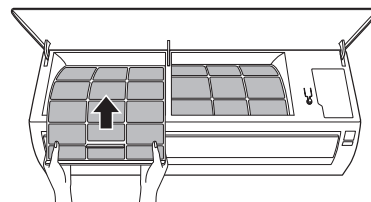

- 7 Check the side of the front cover for correct assembly of the air filters.

## Clean the 3M and Triple Filter (Optional)

- 1 Turn off the power to the unit.
- 2 Remove the air filters from the indoor unit.
- 3 Remove the 3M and Triple filter from the indoor unit.

### Type1

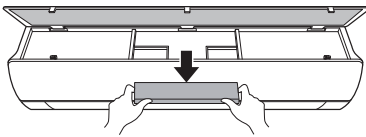

### Type2

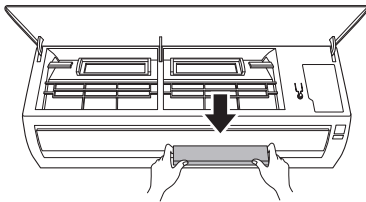

- 4 Clean the filter with a vacuum cleaner.

- 5 Insert the 3M and Triple filter.

### Type1

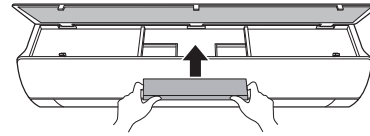

### Type2

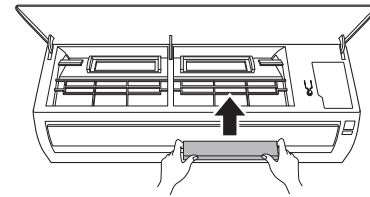

- 6 Assemble the air filters.
- 7 Check the side of the front cover for correct assembly of the air filters.

### NOTE

- The feature and location of 3M and Triple filter may vary according to the type of model.

# TROUBLESHOOTING

## Before Calling for Service

Please check the following before you contact the service center. If the problem persists, contact your local service center.

Problem	Possible Causes	Corrective Action
<b>The air conditioner does not work normally.</b>	<b>Burning smell and strange sounds are coming from the unit.</b>	<ul style="list-style-type: none"><li>• Turn off the air conditioner, switch OFF, or disconnect the power supply, and contact the service center.</li></ul>
	<b>Water leaks from the indoor unit even when the humidity level is low.</b>	
	<b>The power cable is damaged or it is generating excessive heat.</b>	
	<b>A switch, a circuit breaker (safety, ground), or a fuse is not operated properly.</b>	

Problem	Possible Causes	Corrective Action
<b>The air conditioner does not work.</b>	<b>The air conditioner is unplugged.</b>	<ul style="list-style-type: none"> <li>• Check whether the power cord is plugged into the outlet or the power isolators are switched on.</li> </ul>
	<b>A fuse exploded, or the power supply is blocked.</b>	<ul style="list-style-type: none"> <li>• Replace the fuse or check if the circuit breaker has tripped.</li> </ul>
	<b>A power failure has occurred.</b>	<ul style="list-style-type: none"> <li>• Turn off the air conditioner when a power failure occurs.</li> <li>• When the power is restored, wait 3 minutes, and then turn on the air conditioner.</li> </ul>
	<b>The voltage is too high or too low.</b>	<ul style="list-style-type: none"> <li>• Check if the circuit breaker has tripped.</li> </ul>
	<b>The air conditioner was turned off automatically at a preset time.</b>	<ul style="list-style-type: none"> <li>• Turn the air conditioner on.</li> </ul>
	<b>The battery setting in the remote controller is incorrect.</b>	<ul style="list-style-type: none"> <li>• Make sure that the batteries are inserted correctly in your remote controller.</li> <li>• If the batteries are placed correctly, but the air conditioner still does not operate, replace the batteries and try again.</li> </ul>

<b>Problem</b>	<b>Possible Causes</b>	<b>Corrective Action</b>
<b>The air conditioner does not emit cool air.</b>	<b>Air is not circulating properly.</b>	<ul style="list-style-type: none"> <li>• Make sure that there are no curtains, blinds, or pieces of furniture blocking the front of the air conditioner.</li> </ul>
	<b>The air filter is dirty.</b>	<ul style="list-style-type: none"> <li>• Clean the air filter once every 2 weeks.</li> <li>• See “Clean the Air Filter” for more information.</li> </ul>
	<b>The room temperature is too high.</b>	<ul style="list-style-type: none"> <li>• In summer, cooling the indoor air fully may take some time. In this case, select the Jet Mode to cool the indoor air quickly.</li> </ul>
	<b>Cold air is escaping from the room.</b>	<ul style="list-style-type: none"> <li>• Make sure that no cold air is escaping through the ventilation points in the room.</li> </ul>
	<b>The desired temperature is higher than the current temperature.</b>	<ul style="list-style-type: none"> <li>• Set the desired temperature to a level lower than the current temperature.</li> </ul>
	<b>There is a heating source nearby.</b>	<ul style="list-style-type: none"> <li>• Avoid using heat generators like electric ovens or gas burners while the air conditioner is in operation.</li> </ul>
	<b>Fan Mode is selected.</b>	<ul style="list-style-type: none"> <li>• During Fan Mode, air blows from the air conditioner without cooling or heating the indoor air.</li> <li>• Switch the operation mode to cooling operation.</li> </ul>
	<b>Outside temperature is too high.</b>	<ul style="list-style-type: none"> <li>• The cooling effect may not be sufficient.</li> </ul>
<b>The fan speed cannot be adjusted.</b>	<b>The Jet Mode, or Auto Operation Mode is selected.</b>	<ul style="list-style-type: none"> <li>• In some operation modes, you cannot adjust the fan speed. Select an operation mode in which you can adjust the fan speed.</li> </ul>
<b>The temperature cannot be adjusted.</b>	<b>The Fan Mode or Jet Mode is selected.</b>	<ul style="list-style-type: none"> <li>• In some operation modes, you cannot adjust the temperature. Select an operation mode in which you can adjust the temperature.</li> </ul>

<b>Problem</b>	<b>Possible Causes</b>	<b>Corrective Action</b>
<b>The air conditioner stops during operation.</b>	<b>The air conditioner is suddenly turned off.</b>	<ul style="list-style-type: none"> <li>• The Timer Function may have timed out, which turns the unit off. Check the timer settings.</li> </ul>
	<b>A power failure has occurred during operation.</b>	<ul style="list-style-type: none"> <li>• Wait for the power to come back. If you have the Auto Restart function enabled, your unit will resume its last operation several minutes after power is restored.</li> </ul>
<b>The indoor unit is still operating even when the unit has been turned off.</b>	<b>The Auto Clean function is being operated.</b>	<ul style="list-style-type: none"> <li>• Allow the Auto Clean function to continue since it removes any remaining moisture inside the indoor unit. If you do not want this feature, you can turn the unit off.</li> </ul>
<b>The air outlet on the indoor unit is discharging mist.</b>	<b>The cooled air from the air conditioner makes mist.</b>	<ul style="list-style-type: none"> <li>• When the room temperature decreases, this phenomenon will disappear.</li> </ul>
<b>Water leaks from the outdoor unit.</b>	<b>In the heating operations, condensed water drops from the heat exchanger.</b>	<ul style="list-style-type: none"> <li>• This symptom requires installing a drain hose under the base pan. Contact the installer.</li> </ul>
<b>There is noise or vibration.</b>	<p><b>A clicking sound can be heard when the unit starts or stops due to movement of the reversing valve.</b></p> <p><b>Creaking sound: The plastic parts of the indoor unit creak when they shrink or expand due to sudden temperature changes.</b></p> <p><b>Flowing or Blowing sound: This is the flow of refrigerant through the air conditioner.</b></p>	<ul style="list-style-type: none"> <li>• These are normal symptoms. The noise will stop.</li> </ul>

<b>Problem</b>	<b>Possible Causes</b>	<b>Corrective Action</b>
<b>The indoor unit gives off an odor.</b>	<b>Odors (such as cigarette smoke) may be absorbed into the indoor unit and discharged with airflow.</b>	<ul style="list-style-type: none"> <li>• If the smell does not disappear, you need to wash the filter. If this does not work, contact the service center to clean your heat exchanger.</li> </ul>
<b>The air conditioner does not emit warm air.</b>	<b>When Heating Mode starts, the vane is almost closed, and no air comes out, even though the outdoor unit is operating.</b>	<ul style="list-style-type: none"> <li>• This symptom is normal. Please wait until the unit has generated enough warm air to blow through the indoor unit.</li> </ul>
	<b>The outdoor unit is in Defrosting Mode.</b>	<ul style="list-style-type: none"> <li>• In Heating Mode, ice/frost is built up on the coils when the outside temperature falls. This function removes a layer of frost on the coil, and it should finish in approximately 15 minutes.</li> </ul>
	<b>Outside temperature is too low.</b>	<ul style="list-style-type: none"> <li>• The heating effect may not be sufficient.</li> </ul>

**NOTE**

- Some functions may not be supported, depending on the model.

# 8 Consumer services

## Dear Customer,

Beko Call Centre is available 24/7.  
From land lines or mobile phones, dial our call centre number without the area code for all your product related queries.

Calls to our call centre are charged according to the tariff designated by the mobile/land line operator.

Please fill out the form on the "Consumer Services" page of our website at [www.arcelik.com.tr](http://www.arcelik.com.tr) or send us a fax at 0216 423 23 53 to reach our Call Centre.

Our address for written applications:  
Arçelik Çağrı Merkezi, Arçelik A.Ş. Ankara Asfaltı Yanı, 34950 Tuzla/İSTANBUL Up-to-date contact information of our Authorized Services may be found at [www.arcelik.com.tr](http://www.arcelik.com.tr) web site

## Beko Call Center 444 0 888

(Please call without dialling the area code from land lines or mobile phones")

## Alternative Number 0216 585 8 888

## Please follow the following recommendations.

- 1 When you purchase the product, please have its Warranty approved by your Authorized Dealer.
- 2 Use your product in accordance with the principles of the manual.
- 3 Make an application to our call centre from the telephone numbers above when you have a service demand related to your product.
- 4 Ask for the "technician ID" to the technician that comes for the service.
- 5 When s/he is finished, remember to ask for a Service Form from your technician. This "Service Form" will be of use in case of a problem with your product in later stages.
- 6 Expected life of a product: 10 years. (The spare parts necessary for the product to function will be available for this period.)

## Customer Satisfaction Policy

Arçelik A.Ş. adopts a customer oriented approach with the major principle of providing our customers excellent experience where our brand of service can conveniently communicate customer requests and comments from every channels (phone, e-mail, [www.arcelik.com.tr](http://www.arcelik.com.tr), fax, letter, social media, service, dealer, call centre) regardless of customer's profile and all these requests and comments are gathered in a single pool of information which is traceable, reportable, transparent and reliable and all records are handled with confidentiality, objectively and fairly in line with legal regulations and assessed and the processes are continuously controlled and improved.

In parallel with our approach, all processes are integrated to management system and system which controls the other system is established. Management targets are also fed via this system.

## Evaluation of the service request

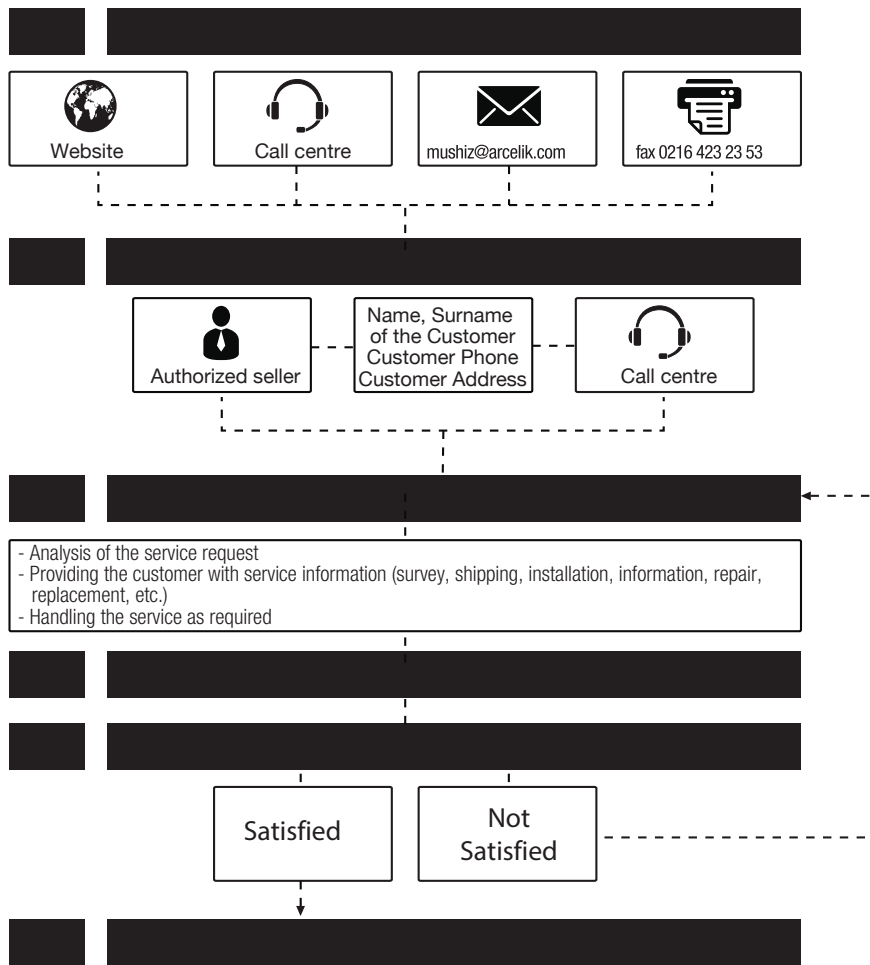



# Customer needs to pay attention to the warranty.

---

Paid repair service is required for failures listed below. Warranty terms do not apply for these conditions.

- 1) Damages and malfunctions due to incorrect use,
- 2) Damages and malfunctions occurring during the loading, unloading and handling after the product is delivered to the customer,
- 3) Damages and malfunctions on-site caused by failures in utility services such as electricity, water, gas, phone, etc.
- 4) Damages and malfunctions caused by acts of nature and fire, flood, etc.
- 5) The malfunctions occurring due to the product being used against the conditions specified in the instruction and user guides.
- 6) Damages and malfunctions arisen in case of utilization of the goods for commercial or occupational purposes with the method as prescribed in 6502 numbered law on the protection of the consumer.

In case intervention is made for goods such as repair and maintenance or any other reason by unauthorized persons, the warranty granted for the product shall expire.

The warranty period for the product replaced during warranty application is limited to the remaining warranty period of the replaced product.

Manufactured by Arçelik A.Ş.

# Certificate Of Warranty

## Air Conditioner

### **CERTIFICATE OF WARRANTY**

- 1) The warranty period shall commence upon the delivery of the product and is specified as 3 years.
- 2) Starting from the delivery date, this warranty shall cover the whole product including all the parts incorporated for material, workmanship and manufacturing errors during the period specified above on the condition that the product has been used in accordance with the introductory and user manuals and has not been interfered for maintenance, repair or another purpose by persons other than those authorised by Arçelik A.Ş.
- 3) If the product is defective, in compliance with the clauses laid down in the Article 11 of the Law no. 6502 on Consumer Protection; the consumer shall become entitled to use one of the rights listed below
  - a- To cancel the contract,
  - b- To claim a deduction on the sale price,
  - c- To claim a free of charge repair,
  - d- To claim product replacement with a free of defects equivalent.
- 4) If the consumer prefers his/her right to get a free of charge repair; the seller shall be liable for repairing the product or have it repaired without charging any fees under the name of labour cost, replaced part cost or any other reason. Also, the consumer shall be able to use his/her right to get a free of charge repair against the manufacturer or the importer. The seller, the manufacturer and the importer shall be severally liable for the customer to use this right.
- 5) In the case that the consumer uses his/her right to get a free of charge repair, if;
  - The product breaks down again within the warranty period,
  - If the maximum duration required for repair is exceeded, If the authorised service centre, the seller, the manufacturer or the importer designates the product as irreparable; the consumer shall be entitled to claim refund, deduction on the price in the ratio of the defect or a replacement with a free of defect equivalent, if present, from the seller. The seller shall not have the right to reject the consumer's claim. The seller, the manufacturer and the importer shall be severally liable in the event that this claim has been rejected.
- 6) The maximum repair duration for the product cannot exceed 20 workdays during its service life specified in the relevant legislation. This period shall commence; on the date of submitting the failure of product to the authorised service centre or to the seller within the warranty period, or on the date of delivery of the product to the authorised service station out of the warranty period. If the product under warranty cannot be repaired within 10 workdays, the manufacturer or the importer shall; be obliged to assign another product with similar specifications to the consumer's use until the defective product is repaired. If the consumer does not demand another product with similar specifications, the manufacturer or the importers shall be released from this obligation. If the product breaks down within the warranty period, the down time shall be added to the warranty period.
- 7) Damages and failures resulting from using the product contrastively with the rules specified in the user manual are not covered by the warranty.
- 8) The consumer shall be able to go to the Consumer Arbitration Court or the Consumer Court found in the area where the place of residence is included or where the consumer processes are carried out in the case of disputes regarding the rights that come with the warranty.
- 9) If this certificate is not provided by he seller, the consumer shall have the right to refer to the Ministry of Customs and Trade Consumer Protection and the General Directorate of Market Surveillance.

#### **Manufacturer's or Importer's:**

**Title:** Arçelik A.Ş.  
**Address:** Arçelik A.Ş. Karaağaç Caddesi No:2-6, 34445,  
Sütlüce / İSTANBUL  
**Phone:** (0-216) 585 8 888  
**Fax:** (0-216) 423 23 53  
**web address:** www.altus.com.tr

#### **The Product's**

**Brand:** Beko  
**Type:** Air Conditioner  
**Model:**  
**Banderole and Serial No:**  
**Warranty Period:** 3 YEARS  
**Maximum Repair Duration:** 20 Workdays

GENERAL MANAGER

*Hakan Bülent*

**Arçelik A.Ş.**

DEPUTY GENERAL MANAGER

*Adnan*

#### **The Seller's:**

**Title:**  
**Address:**  
**Phone:**  
**Fax :**  
**e-mail:**

**Date and Number of Invoice:**  
**Date and Place of Delivery:**  
**Authorised Signature:**  
**Company Seal:**

The Authorised Seller who sold you the product shall sign and stamp this field.