

AKAI

PROTECT YOUR WARRANTY
This unit must be installed by a registered,
licensed installer as required by
Government regulations.

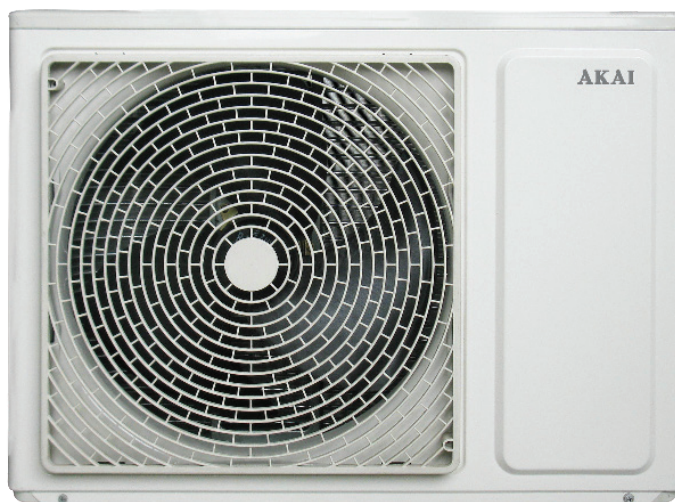

Reverse Cycle Split System Air Conditioner

USER MANUAL

Model Number AK-9000-RC



N13275

Contents

Important Safety Instructions	3
Product Overview	6
Getting Started	10
Instructions	12
Cleaning and Maintenance	15
Troubleshooting Guide	17

Important Safety Instructions

IMPORTANT!

This unit comes with separate installation instructions for use by an appropriately qualified and licensed installer. Do not try to install the unit on your own; doing so will expose you to danger and void the warranty.

It is your responsibility to ensure the unit is installed by a qualified technician, who should check that it is earthed in accordance with applicable regulations and install a thermomagnetic circuit breaker.

Read this manual thoroughly before having the appliance installed and using it. It contains many important safety statements concerning the use of this appliance. Always read and observe all safety statements. They reduce the risk of fire, electric shock and injury when correctly adhered to.

Keep the manual in a safe place for future reference, along with any warranty information, purchase receipt and carton. If applicable, pass these instructions on to the next owner of the appliance.

Electrical Safety

- **Voltage:** Make sure your electrical voltage and circuit frequency correspond to those indicated on the appliance rating plate.
- **Power plug:** Keep the power plug clean. To avoid the risk of electric shock, overheating or fire, insert the plug correctly and firmly into the socket.
- **Electrical outlet:** Check and ensure that the socket is suitable for the plug, otherwise have the socket changed; do not alter the plug. Use an exclusive socket to avoid overloading the electrical circuit.
- **No extension cord:** Do not use the unit with an extension cord or adaptor.
- **Power cord:** Do not bend, tug or compress the power cord as this could damage it. A damaged power cord can cause electric shock or fire.
- **Damaged cord:** If the supply cord is damaged, it must be replaced by the manufacturer, its service agent or similarly qualified persons in order to avoid a hazard. Contact our after sales support line for advice.
- **Protect from water:** Do not expose the indoor unit or remote control to water. Doing so may cause electric shock, short circuit or fire. Do not touch the power plug when barefoot or with wet hands.
- **Do not disconnect during use:** Pulling out the plug to switch off the appliance when it is in operation could create a spark and cause a fire.
- **When to disconnect:** Ensure that the indoor unit is switched off and disconnected from the power supply when it will remain inoperative for a long period, before cleaning or maintenance and when a thunderstorm is approaching. Grip the plug when disconnecting, do not pull the cord.

Important Safety Instructions (Cont.)

Usage Conditions and Restrictions

- **Domestic use:** This appliance has been made for air conditioning domestic environments and may also be used by expert or trained users in shops, light industry environments and farm houses.
- **Intended purpose:** This appliance should only be used as described in this manual. It should not be used for any other purpose, such as for drying clothes, cooling food etc. The appliance is not suitable for cooling environments appropriate for long term storage of fresh food or precision instrumentation.
- **Common sense:** These instructions are not intended to cover every possible condition and situation. As with any electrical household appliance, common sense and caution are therefore always recommended when installing, operating and maintaining the unit.
- **Usage restriction:** This appliance can be used by children aged from 8 years and above and persons with reduced physical, sensory or mental capabilities, or lack of experience and knowledge, IF they have been given supervision or instruction concerning use of the appliance in a safe way and understand the hazards involved.
- **Children:** Cleaning and user maintenance shall not be made by children without supervision. Children should be supervised to ensure they do not play with the appliance.
- **Dust filter:** This appliance should always be used with the air filter mounted. Operation without dust filter could cause an excessive accumulation of dust on the interior parts with possible subsequent failures.
- **Exposure to cold air flow:** Never remain directly exposed to the flow of cold air for a long time, as direct and prolonged exposure to cold air from the air conditioner could be dangerous for your health. Do not direct the airflow onto plants or animals, as long and direct exposure to cold air could adversely affect them.
- **Appropriate temperature:** Take particular care with exposure to cold air flow in rooms where there are children, old or sick people. The most appropriate temperature should generally be no more than 5 degrees lower than the outside temperature. Selecting the most suitable temperature can also prevent damage to the unit.
- **Do not block openings:** Do not obstruct the air inlet or outlet of the indoor or outdoor unit. Obstructing openings reduces the operating efficiency of the air conditioner with possible consequent failure or damage.

Important Safety Instructions (Cont.)

- **Keep clear:** Do not climb onto or place any objects on top of the outdoor unit. Supervise children to ensure they do not sit on the outdoor unit.
- **Air inlet/outlet:** Never insert a finger, stick or similar object into these openings. As a fan is rotating at a high speed, it will cause injury and/or damage to the appliance.
- **Wind vanes:** Do not touch the swinging wind vanes. Doing so may trap your finger(s) and damage the driving parts of the wind vanes.
- **Windows and doors:** To maximise efficiency, do not leave windows or doors open for long when the air conditioner is operating. Open windows frequently after using the air conditioner for a long time.
- **Inappropriate locations:** Do NOT install the air conditioner units:
 - ☒ in a place where there are flammable gases or liquids.
 - ☒ in a place where it is directly exposed to sunshine (indoor unit).
- **Interference:** In cases where severe interference from devices such as mobile phones causes the air conditioner to shut off, switch off and unplug the unit, then reconnect after several seconds and restart the air conditioner.

Cleaning, Servicing and Repair

- **Disconnect before cleaning:** Before carrying out any cleaning or maintenance, make sure the unit is disconnected from the mains electricity supply.
- **Plug:** Keep the plug free of dust.
- **Indoor unit:** Only dust the indoor unit. Do not use liquid or corrosive cleaning agents on any part of the indoor or outdoor units.
- **Professional care:** Cleaning and maintenance must be carried out by specialised technical personnel.
- **Repair:** Only have the unit repaired by an authorised service centre. Do not attempt to repair the unit yourself. Incorrect repair could expose you to the risk of electric shock, fire or injury. Prolonged use of the unit in such conditions could cause fire or electrocution.

Please refer to the Installation Manual for safety instructions specific to the installation of the indoor and outdoor units.

ATTENTION!

Depending on the mains electricity supply, voltage drops may occur when starting the air conditioner, which can influence other equipment (for example, blinking of a lamp). Should such disturbances happen, please contact your local electricity provider for further information.

Product Overview

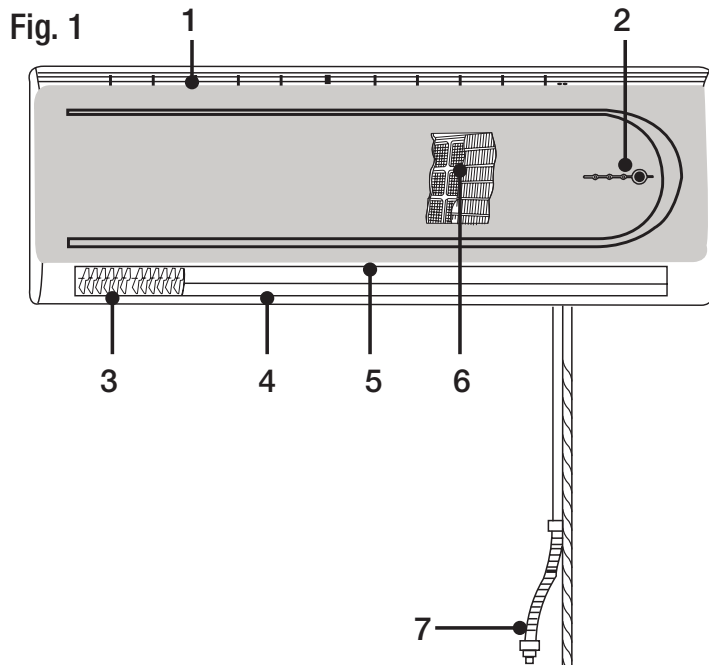

Indoor Unit (Fig. 1)

- 1 Air return grid
- 2 Operational performance indications
- 3 Adjustment fin for left/right airflow direction
- 4 Adjustment flap for up/down airflow direction
- 5 Air outlet
- 6 Air filter
- 7 Drain tube

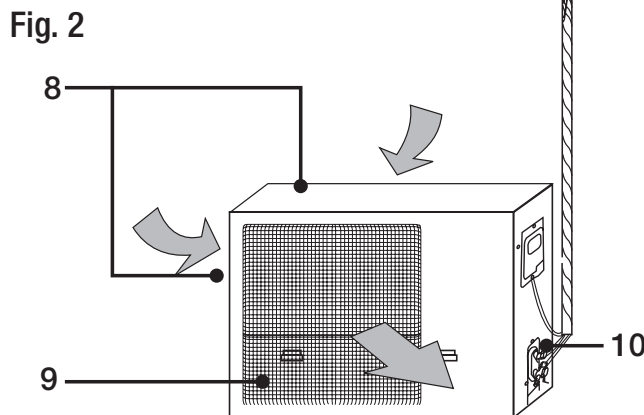

Outdoor Unit (Fig. 2)

- 8 Air inlet
- 9 Air discharge vent
- 10 Refrigerant pipe connection and electric wiring cord

This Air Conditioner is made up of an indoor unit (Fig. 1 & Fig. 3), outdoor unit (Fig. 2) and a remote control (Fig. 4 & Fig. 5). The **indoor unit** is installed on a wall of the room to be air conditioned. The **outdoor unit** is installed in a protected area outdoors, on the ground or on a wall on suitable brackets.

NOTE: Figures and descriptions throughout this user manual are for explanatory and illustrative purposes only and may differ slightly from the appearance of the product purchased.

Product Overview (Cont.)

Indoor Unit Display Indications

Fig. 3

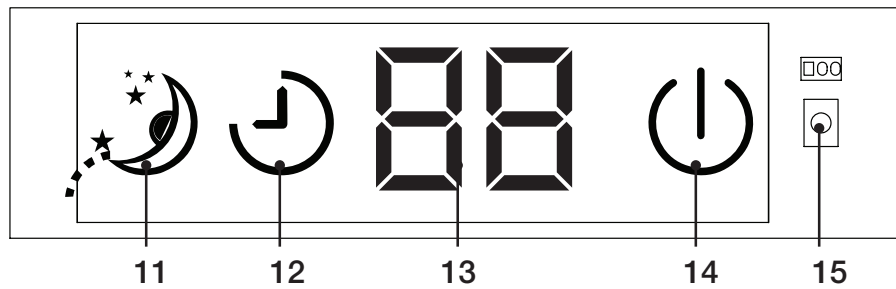

- 11 Indicates Sleep mode
- 12 Indicates Timer mode
- 13 Indicates the set temperature, timer time and malfunction code
- 14 Indicates that the unit is running
- 15 Remote controller signal receiver

Product Overview (Cont.)

Remote Control

Fig. 4

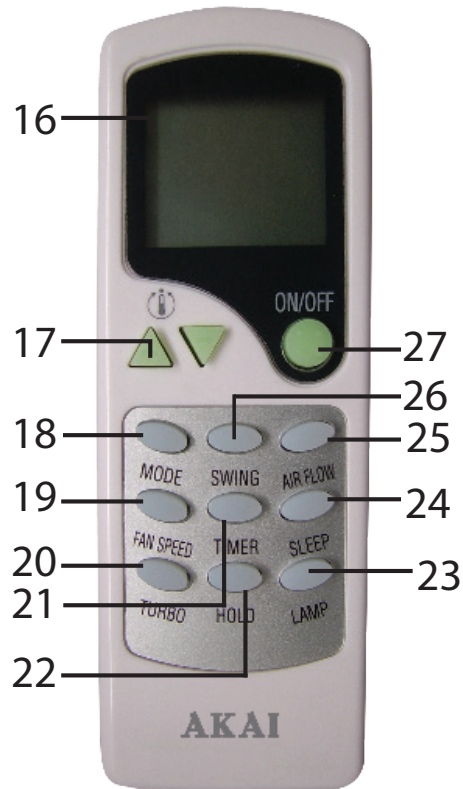

- 16 LCD Display (see page 9 for details)
- 17 SET TEMPERATURE: press these up and down arrow buttons to set the room temperature
- 18 MODE: press this button to select the operation mode (Auto, Cool, Dry, Heat, Fan)
- 19 FAN SPEED: press to select the fan speed
- 20 TURBO: press this button to select Turbo operation (This function only works in Cool and Heat mode. When this function is selected, the room temperature is not controlled automatically. If the room temperature drops or rises too much, please cancel the TURBO operation.)
- 21 TIMER: press this button to switch the timer on/off or set the timer time
- 22 HOLD: press to lock or unlock the keypad
- 23 LAMP: press this button to turn the indoor unit display on/off
- 24 SLEEP: press to activate Sleep mode
- 25 AIRFLOW: press this button to select the left/right or fixed airflow direction (only effective with the three-dimensional airflow model)
- 26 SWING: press to change the airflow (flap) mode (natural flow, swing or fixed)
- 27 ON/OFF: press to start or stop operation

Product Overview (Cont.)

Remote Control LCD

Fig. 5

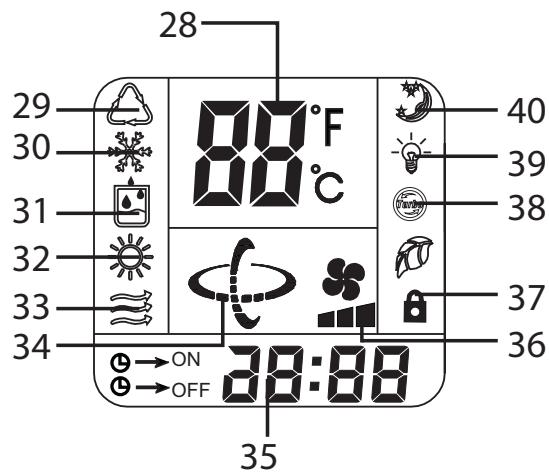

- 28 Temperature indicator: indicates the set temperature
- 29 Mode indicator: Auto
- 30 Mode indicator: Cool
- 31 Mode indicator: Dry
- 32 Mode indicator: Heat
- 33 Mode indicator: Fan
- 34 Swing indicator: indicates the set flap (airflow) mode
- 35 Time indicator: indicates the timer time
- 36 Fan speed indicator: indicates the selected fan speed
- 37 Key lock indicator
- 38 Turbo indicator: illuminates during Turbo operation
- 39 Display indicator
- 40 Sleep indicator: illuminates during Sleep mode

The remote control must be in power on state for the LCD to display the currently set values

Getting Started

Remote Control Operation

Before you can use the remote control to operate the indoor unit, make sure it contains appropriate batteries.

Inserting batteries

- Remove the cover from the battery compartment by sliding it off the housing.
- Insert 2 new AAA (1.5V) batteries (included), ensuring the polarities (+/-) match the markings inside the compartment.
- Refit the cover by sliding it back into place.

Battery precautions

- The remote control unit runs on 2 AAA (1.5V) batteries. Do not use rechargeable batteries.
- Replace old batteries with new ones of the same type when the display is no longer legible, when the noise of the transmitting signal cannot be heard or when the unit resets itself on pressing a remote control button.
- Take the batteries out of the remote control when you are not going to use the air conditioner for a long time.
- Dispose of your remote control batteries in accordance with your local laws and regulations concerning battery disposal.

Basic remote control usage

- Aim the remote control towards the signal receiver at the front of the indoor unit and press the appropriate button on the remote control. A signal is sent to the indoor unit and when this signal is received correctly, the unit will emit a brief beep sound.
- Ensure the remote control is within 8 metres of the LCD display on the indoor unit, and that no objects are blocking the path of the signal.
- Handle the remote control with care. Do not drop or throw it.
- Do not leave the remote control in direct sunlight or close to sources of heat.

Turn to page 12 for instructions how to operate the air conditioner with the remote control unit.

Getting Started (Cont.)

Manual Operation

When the remote control does not work or cannot be found, please follow the steps below to start or stop operation.

- **To open the unit,** lightly push both sides of the air inlet grid at the bottom of the indoor unit (Fig. 6) and pull it to the side until you feel a slight resistance.

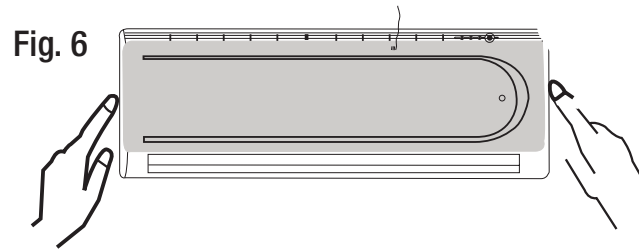

- **To switch the unit on or off,** press the manual operation button, which is visible when you have opened the unit (Fig. 7).

Fig. 7

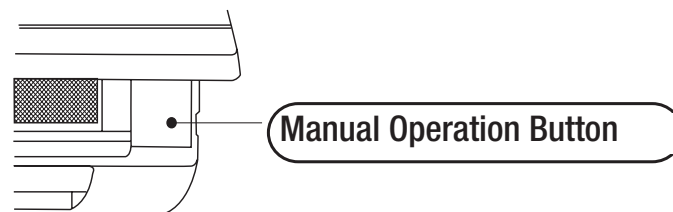

- **To close the unit,** push down the air inlet grid and gently push both sides at the bottom to close.

NOTE: Do not open the grid at a larger than 60 degree angle.
Do not operate the unit with too much force.

Instructions

Remote Control Operation of the Indoor Unit

- Point the remote controller at the unit and press the ON/OFF button.
- Press the MODE button, repeatedly, to select the desired mode from the following options: Auto, Cool, Dry, Heat, Fan.
- Press the SET TEMPERATURE buttons to increase or decrease the readings until the desired temperature is displayed. The available temperature range is from 16°C-32°C.

NOTE: In Auto and Dry mode, the temperature is automatically set to 25°C and cannot be adjusted.

- Press the FAN SPEED button, repeatedly, to select the desired fan speed from the following options:
Low [■], Medium [■■], High [■■■] or Auto [■■■ flashing].

NOTE: In Dry mode, the fan speed is automatically set to low speed and cannot be adjusted.

- Press the SWING button, repeatedly, to select the desired up/down airflow direction from the following options:
Natural flow [(), Swing [(flashing)] or Fixed direction [(ˆ)].

NOTE: In Dry mode, the airflow is automatically set to fixed direction.

Special Features

Turbo Operation

- Press the TURBO button during Cool or Heat operation to set the airflow rate to High for fast cooling or heating.
- Press the TURBO button again to cancel Turbo operation.

NOTE: During Turbo operation the airflow rate cannot be changed.

Adjusting the Left/Right Airflow Direction

Horizontal swing adjustment

To adjust the direction with the remote controller, press the AIRFLOW button to set the air delivery to automatic left/right swing or fixed airflow direction.

Instructions (Cont.)

Timer Operation

The TIMER button allows you to program the timer for automatic switch on/off.

Setting the turning OFF time (automatic stop)

Set the time for the unit to turn off and when it is time, the air conditioner will automatically stop operating.

- During the operation of the air conditioner, press the TIMER button and the air conditioner will enter the timed switch-off mode.
- Press the TIMER button continuously to set the time period after which you want the air conditioner to switch off. The time can be set from 1 hour to 24 hours in one-hourly steps. Every time you press the button the indicator shows the set period, as follows: 1 * 2 * 3 * 4 * ... 24 * Cancel * 1...
- After setting the timed switch-off, the countdown to the switch-off will start and the digits shown on the display screen will go down by 1 for every elapsed hour. The displayed digits indicate the remaining time prior to the timed switch-off.

Setting the turning ON time (automatic start)

Set the time for the unit to turn on and when it is time, the air conditioner will automatically start operating.

- When the air conditioner is in standby mode, press the TIMER button and the air conditioner will enter the timed switch-on mode.
- Press the TIMER button continuously to set the time period after which you want the air conditioner to switch on. The time can be set from 1 hour to 24 hours in one-hourly steps. Every time you press the button the indicator shows the set period, as follows: 1 * 2 * 3 * 4 * ... 24 * Cancel * 1...
- After setting the timed switch-on, the countdown to the switch-on will start and the digits shown on the display screen will go down by 1 for every elapsed hour. The displayed digits indicate the remaining time prior to the timed switch-on.

Timer reset

- To cancel the set timer-on or timer-off time, press the ON/OFF button.

Instructions (Cont.)

Sleep Operation

The Sleep function is designed for use at night when you want to sleep. It reduces the unit's operation sound. The Sleep function also enables the set temperature to rise or drop gradually, so the unit will consume less power at night-time, running at an adjusted temperature.

- Press the SLEEP button to activate Sleep mode. The air conditioner will run with a lowered airflow sound from the indoor unit.
- **Cooling mode:** In Sleep mode, the cooling operation enables the set temperature to rise gradually to 2°C above the set temperature.
- **Heating mode:** In Sleep mode, the heating operation enables the set temperature to drop gradually to 5°C below the set temperature.
- Press the SLEEP button again to deactivate the Sleep mode.

NOTE: Use the Sleep function when you are going to bed. If you set the Sleep function during the day, the cooling capacity is reduced since the ambient temperature is too high at daytime.

Basic Heating Principles

The air conditioner absorbs heat from the outdoor air and transfers it indoors so as to heat the room air. The heating capabilities of this heat pump principle go up/down with the increase/decrease of the outdoor air temperature.

- It only takes a fairly short time for such hot air circulation system to raise the room temperature.
- When the outdoor air temperature is very low, the system can be used together with other heating devices. But good ventilation should be maintained to ensure personal safety and prevent accidents.

Defrosting

When the outdoor air temperature is very low and humidity is very high, the heat exchanger of the outdoor unit may frost up, which has negative impacts upon the efficiency of the heating performance. In such a case, the automatic defrosting function will activate, which will stop the heating operation for 5-10 minutes to defrost the unit.

- The fans of both the outdoor and indoor units are stopped.
- During the defrosting, the outdoor unit might generate some steam. It is caused by fast defrosting, which is not a performance failure.
- Upon the completion of the defrosting process, the heating operation will be resumed.

Cleaning and Maintenance

Periodic cleaning and maintenance is essential for keeping your air conditioner in good condition and working efficiently.

CAUTION!

Before carrying out any maintenance, make sure the air conditioner is turned off at the power socket outlet.

Start of Season Maintenance

- Check and ensure nothing is blocking the intake and outlet vents of the indoor and outdoor units.
- Check and ensure the installation stand is not corroded or rusty.
- Check and ensure the machine is properly earthed.
- Check and ensure the air filter is clean.
- Check and ensure the unit is properly connected to the power source.
- Put fresh batteries in the remote controller.

During the Season of Operation

- **Remove the air filter screen from the unit.**
 - * Gently press the two lower ends of the grid and open it.
 - * Carefully pull up the air filter screen.
 - * Take out the air filter screen in the direction of your body.
- **Clean the air filter screen.**
 - * If the screen is very dirty, use lukewarm water (about 30°C) to clean it.
 - * Air dry the air filter screen after cleaning.
- **NOTE:** Do not use hot or boiling water to clean the air filter screen.
Do not dry the air filter screen over a fire.
Do not exert too much force when handling the screen.
- **Reinstall the air filter screen** once it is completely dry.
- **NOTE:** If you operate the air conditioner without the air filter screen properly installed, dirt can accumulate inside the unit, which may affect performances or damage the unit.
- **Clean the air conditioner.**
 - * Use a soft, dry cloth to wipe the indoor unit clean.
 - * Alternatively, clean it with a soft brush attachment of a vacuum cleaner.
 - * If the air conditioner is very dirty, use a damp cloth soaked in a mild detergent solution and wrung out so it is not too wet.
- **NOTE:** Do not use thinner, polishing powder, benzene or other volatile or corrosive chemicals for cleaning the appliance.
Do not splash water or other liquid on or into the appliance.

Cleaning and Maintenance (Cont.)

End of Season Maintenance

- Set the temperature to 30°C and operate the unit in Fan mode for about half a day so that the inside of the unit can dry completely. Then stop the operation and turn off the power switch.
- The air conditioner will consume about 5W of electric power after the machine is turned off. For the purpose of energy saving and safety, it is advisable to pull the plug out during the non-operational seasons.
- Clean and install the air filter screen.
- **NOTE:** An air filter screen blocked by dust or dirt will affect the unit's cooling and heating performance and increase its running noise and power consumption. Therefore make sure to clean the air filter screen regularly.
- Clean the indoor and outdoor units.
- Take the batteries out of the remote controller.

Troubleshooting Guide

If you experience problems with your air conditioner, check for solutions in the table below. If the problem cannot be solved by simple adjustments, call the after sales support line, or contact a licensed air conditioner technician.

Problem	Possible cause and solution
The air conditioner does not work at all.	Check and ensure there is no power failure or blown fuse. Also check the timer and ensure the unit is not set to start operating at a later time.
Poor cooling or heating performance.	Check and ensure that the room temperature setting is appropriate, that window(s) and door(s) are closed and that the filters are clean.
Poor cooling performance.	Check and ensure that no direct sunlight is entering the room and that there are no heat sources in the room. A large number of people in the room may also affect the unit's cooling performance.
The unit cannot be restarted just after shutdown (running indicator is illuminated).	After shutting down the unit, you will have to wait for 3 minutes before it can be restarted. This is an internal protection mechanism.
Air is not blown out at the start of the heating operation.	In order to prevent cold air being blown out in Heating mode, airflow is prevented until the indoor heat exchanger has warmed up the air sufficiently. This may take 2 to 5 minutes.
In Heat mode, air is not blown out for 6 to 12 minutes.	On very cold days with high humidity, the air conditioner may perform an automatic defrosting cycle during which water or steam may raise from the outdoor unit. Please wait; heating operation will start automatically after the defrosting cycle.
Air is not blown out in Dry mode.	In Dry mode, the indoor fan is sometimes stopped to save energy and prevent steam generation from moisture evaporation.
Mist is blown out in Cool mode.	This phenomenon sometimes occurs when the temperature and humidity in the room are very high. It will disappear as the temperature and humidity in the room are lowered.
A cracking noise can be heard.	This is caused by the refrigerant that is circulating inside the unit. It is no cause for concern.

Troubleshooting Guide (Cont.)

Problem	Possible cause and solution
A cracking noise can be heard after a power stoppage or after disconnecting the power supply plug.	This noise is caused by heat expansion or contraction of plastics. It is no cause for concern.
After a power outage, operation cannot be restarted.	The memory circuit of the microcomputer is cleared. Operate the remote controller again to restart the operation.
Remote control signals are not received.	Remote control signals may not be received when the signal receiver on the air conditioner body is exposed to direct sunlight or strong lighting. In that case, close curtains or shutters or switch off or dim the light source.
Moisture may form on the air outlet grilles.	If the unit is operated for a long period of time in a high humidity environment, moisture may form on the air outlet grilles and drip down.

Service required!

Switch off the air conditioner immediately and call our after sales support line for service in the event of:

- The fuse or circuit breaker is often triggered.
- Water or other liquid has been splashed into the air conditioner.
- Loud and unusual noises can be heard during operation.
- The electrical wiring and power plug are very hot, or damaged.
- The unit causes repeated interference/malfunction of nearby TV, radio or other electronic devices.
- The air blowing from the outlet has a very strong smell.
- When the unit malfunctions upon pressing the power button, and this malfunction does not disappear, even after pulling out the power plug and restarting the operation after 3 minutes.

Troubleshooting Guide (Cont.)

Self-diagnosis function

This air conditioner is equipped with a self-diagnosis function to help you identify potential problems. Should you encounter problems with your air conditioner, contact our after sales support centre using the details on the bottom of the page. However, before calling for service, consult the self-diagnosis information below.

Self-check information	Indicator light self-check code	Digital self-check code
Defrost indication	Blinks once per second	Indicates "dF" or heating icon blinks
Anti cold wind	Blinks once per second	Fan motor picture not running
Room temperature sensor fault	Blinks once every 8 seconds	E2
Coil temperature sensor	Blinks twice every 8 seconds	E3
Indoor fan fault	Blinks 3 times every 8 seconds	E8
Outdoor feedback	Blinks 6 times every 8 seconds	E5
External feedback fault	Blinks 7 times every 8 seconds	E7
Open the door fault	Blinks 3 times every 8 seconds	E0
Outdoor tube temperature sensor faults	Blinks 4 times every 8 seconds	E1
(EEPROM) Communication failures	Blinks 6 times every 8 seconds	E6
Outdoor temperature exceeds scope (too cold)	Blinks once per second	FF



Warranty returns

Should you for any reason need to return this product for a warranty claim, make sure to include all accessories with the product.

Product does not work?

If you encounter problems with this product, or if it fails to perform to your expectations, make sure to contact our After Sales Support Centre on 1300 886 649 before returning it to the store for a refund.

After Sales Support

☎ 1300 886 649 | ✉ info@tempo.org