

CEM7 PRO

Auto-start digital controller
Manual

Professional manual v_1.0



Warning on the intellectual property

© 2008 HIMOINSA S.L. All rights reserved.

HIMOINSA S.L. is the owner and reserve all rights of ownership on any text or graphic image exposed in this manual. The permission to reproduce all or a part of this manual must be obtained by HIMOINSA S.L. via written document.

Unauthorised use of the information given in this manual, its resale and/or the damage to the Intellectual Property or Industrial rights will entail the responsibilities legally established.

HIMOINSA S.L. and HIMOINSA logo are HIMOINSA trademarks in Spain and other countries.

Unload and limitation of legal responsibility

Information given in the manual, including texts, date and/or pictures, are supplied in their current status by HIMOINSA S.L. in order to facilitate the access to products to its dealers and clients.

HIMOINSA S.L. is not responsible for the errors and/or omissions that may occur in this manual and kindly recommends the commissioning and use of the products to be carried out only by qualified personnel.

The CEM and PHG exchanges comply with the following European standards:

- Electromagnetic compatibility complies with the IN 61326-1:2006 standard
- Electrical safety complies with the IN 61010-1:2001 standard

P0310_PMCEM71.0_IN



- 1. INTRODUCTION 7
 - 1.1. Visualization module 7
 - 1.2. Measurements module 7
 - 1.2.a. The **measurements module** provides the following readings of the electric mains supply (CEM7+CEC7) 8
 - 1.2.b. The **measurements module** provides the following engine features information 8
 - 1.2.c. The **measurements module** has outputs which allow monitoring of the operative conditions of the genset 8
 - 1.2.d. With the bus CAN these additional modules can be added 8
- 2. VISUALIZATION MODULE FRONT VIEW 9
 - 2.1. Display 9
 - 2.2. PULSADORES DE LA CENTRAL 10
 - 2.2.a. Command buttons 10
 - 2.2.b. Pulsadores de comando de la central 10
 - 2.2.c. Display buttons 10
 - 2.3. DATA LED's 11
 - 2.3.a. ENGINE status LED's 11
 - 2.3.b. ALARMS LED's 11
 - 2.3.c. CONTACTORS status LED's (CEM7 + CEC7) 12
 - 2.3.d. PASSWORD 12
- 3. OPERATIONAL MODES 13
 - 3.1. Manual Mode 13
 - 3.2. Automatic mode 13
 - 3.3. Interruption of modes 14
- 4. WORKING MODE 15
 - 4.1. Starting the engine 15
 - 4.2. Engine stop 18
 - 4.3. Transfer fuel pump. (BTC, BTNA) 21
 - 4.4. Pre-Heating 21
 - 4.5. Battery charger alternator 22
 - 4.5.a. Alternator mode 22
 - 4.5.b. Dynamo mode 22
 - 4.6. Start /stop key 22
 - 4.7. Start-up due to load demand (CEM7 + CEC7) 23
 - 4.8. Electronic protection (overload and short-circuit) 23



5. INPUTS AND OUTPUTS	24
5.1. Digital Inputs	25
5.1.a. Presets inputs	25
5.1.b. Programmable inputs	25
5.1.c. Programmable alarms (AL1, AL2 and AL3)	26
5.1.d. Programmable alarms (AL4 and AL5)	26
5.1.e. Selection of parameters set (S1 and S2)	26
5.2. Analogic Inputs	27
5.2.a. Fuel level (FL)	27
5.2.b. Oil pressure input (P)	27
5.2.c. Engine temperature input (T)	27
5.2.d. Alternator voltage input (DI)	27
5.2.e. Auxiliary analog input (AA)	27
5.3. Pick-up Input. (PCK1, PCK2)	28
5.4. Digital outputs programmed	28
5.5. Programmable outputs	29
5.5.a. Inhibited output	29
5.5.b. Output programmed by input status	29
5.5.c. Output programmed by alarm	29
5.5.d. Output programmed by function	30
5.5.e. Output programmed by mode	30
5.5.f. False load programmed output	30
5.6. Expansion programmable outputs	30
6. CEM7 ALARMS	31
6.1. Alarm operating process. Practical example	31
6.2. ALARMS	35
6.2.a. Engine alarm	35
6.2.b. Genset alarms	36
6.2.c. Programmable alarms and inputs	36
6.3. Alarm description	37
7. MAINTENANCE	45
7.1. Working Counters	45
7.2. Maintenance counters	46
7.2.a. Enlargement of the maintenance and rental counters	46
7.3. Fault history	46
7.4. Equipment list	47
7.4.a. Information about equipment list	47
7.4.b. Identifier assign operating process	47
7.5. Reset intensity measurement	47
7.6. Analogue Sensors Slope Programming	47



- 8. EXPANSIONS 48
 - 8.1. Repetitive Visualization Display 48
 - 8.2. Programming timer 49
 - 8.2.a. Installation in visualization module 49
 - 8.3. Telesignal 50
 - 8.3.a. Functions 50
 - 8.4. J1939 51
 - 8.5. Remote visualization screen or repetitive display: (remote visualization option) 51
 - 8.5.a. Functions 51
 - 8.6. Change over power source 52
 - 8.6.a. **Characteristics** **52**
 - 8.7. Second Zero Suppression (CEM7 + CEC7) 52
 - 8.7.a. Functions 52
- 9. (ANNEX I)
COMMUNICATION MODULES 54
 - 9.1. Local mode telecontrol 54
 - 9.1.a. CAN/USB: Telecontrol for a distance less than 1 km 54
 - 9.1.b. CCRS485: Telecontrol via MODBUS protocol 55
 - 9.1.c. CAN/LAN: Local telecontrol Ethernet network (Intranet) 55
 - 9.2. Remote mode telecontrol 56
 - 9.2.a. CAN/RS232: Telecontrol Communications by MODEM 56
 - 9.2.b. CAN/LAN: Telecontrol Remote telecontrol by Ethernet network (Internet) 57
 - 9.2.c. CAN/LAN MODBUS: Communications options for MODBus IP protocol 57
- 10. (ANNEX II)
PARAMETER TABLE 58
- 11. (ANNEX III)
CEM7 DEVICE DISPLAY. FIGURES AND READINGS 71
 - 11.1. Status of the device 71
 - 11.1.a. Generator figures displayed 71
 - 11.1.b. Engine status display 72
 - 11.1.c. Control board status display 72
 - 11.1.d. Power and energy display 72
 - 11.2. Failures record 73
 - 11.2.a. Failures display 73
 - 11.3. Control board maintenance 73
 - 11.3.a. Introducing password 73
 - 11.3.b. Main menu 73
 - 11.4. Error list J1939 79
 - 11.5. Start list J1939 80
 - 11.6. Control board programming 80
 - 11.7. Texts 80



11.8. Text personalization of the programmable alarms	81
11.9. Personalization of manufacturer's screen	81
11.10. CCLAN	81
11.11. Sensors slope programming	81
12. (ANNEX IV) DIMENSIONS, CONNECTIONS AND MECHANIZATION	83
12.1. Measures module	83
12.2. Módulo de visualización	88
12.3. Electric characteristics	90
13. (ANNEX V) GENERAL CONSIDERATIONS, CHARACTERISTICS AND INSTALLATION OF THE EQUIPMENT	92
13.1. General considerations	92
13.2. Characteristics	92
13.3. Installation	92
14. (ANNEX VI) CAN COMMUNICATIONS	93
14.1. Introduction	93
14.2. Topology	93
14.3. Wiring	94
14.4. Wiring diagrams	95
15. (ANNEX VII) TELESIGNAL: COMMUNICATION OPTION BY DIGITAL OUTPUTS	97
15.1. Telesignal components	97
15.2. Telesignal programation	98
15.3. Working mode	99
15.4. Wiring of the Telesignal option	100
15.5. Dimensions and connections	101
15.6. Electric characteristics	103
16. (ANNEX VIII) CCRS: COMMUNICATION OPTION VIA MODEM	104
16.1. CCRs installation	104
16.1.a. System requirements	104
16.1.b. Communicating with the controlboard	104



CENTRAL CEM7 PRO

1. INTRODUCTION

THE CEM7 CONTROLLER IS A MONITORING SYSTEM FOR THE GENSET'S ELECTRICAL SIGNAL WHICH ALSO MANAGES THE GENERATING SET'S ENGINE CONTROL.

THE DEVICE CONSISTS OF 2 DIFFERENT MODULES:

1.1. Visualization module.

The **visualization module** provides information about the status of the device and, at the same time, allows the user to interact with it. With this **visualization module** the user is able to control, program and configure the functions of the unit. This **visualization module** allows the checking of the last ten failures registered in the control unit. (**Fault history**).

NOTE: An optional Programming Timer module can be added to display module, which would allow it to carry out start-up, locking, and programmed maintenance functions. Likewise the programming clock module allows extending the historical failures records capacity.

1.2. Measurements module.

The **measurements module** controls and monitors the control board. It is located in the rear part of the panel, in order to reduce the wiring and to avoid electromagnetic disturbances. Every signal, sensor and actuator is connected to this module.(see Annex III figures)



1.2.a. The measurements module provides the following readings of the electric mains supply (CEM7+CEC7).

- Phase to neutral voltage.
- Phase to phase voltage.
- Phase amperage.
- Frequency.
- Real, apparent and reactive powers.
- Power factor and $\cos \phi$.
- Instant power (KwH) and historical power (day, month, year) with programming timer option.

1.2.b. The measurements module provides the following engine features information:

• **Engine alarm inputs:**

- Fuel reserve.
- Oil pressure.
- Coolant temperature.
- Coolant level.
- Emergency stop. (Stop button).

• **Analogic engine inputs**

- Fuel level.
- Oil Pressure.
- Coolant Temperature.
- Configurable input (i.e. Oil temperature).
- Battery charge alternator voltage.

• **Configurable inputs**

The **measurements module** has 5 inputs that they can be programmed to carry out the following functions:

- EJP1 Rate change notice (CEM7+CEC7)
- EJP2 Rate change (CEM7+CEC7).
- Start disabling.
- External start.
- Test (CEM7+CEC7).
- Manual override.
- 5 programmable alarms.
- Self-programming (S1-S2)

• **Engine statistics:**

- Number of working hours.
- Number of starts.

• **The measurements module controls the following functions of the engine:**

- Pre-heating or Glow Plug.
- Stop.
- Start.
- Coolant heater (CEM7+CEC7).
- Fuel Transfer pump.
- Battery charging alternator excitation.

1.2.c. The measurements module has outputs which allow monitoring of the operative conditions of the genset:

- Engine running (on).
- General alarm.
- 3 programmable outputs which monitor the control board alarm conditions or the inputs about the engine data.

The measurements module commands outputs to relays for the activation of the genset contactor and the electronic overload and short-circuit protection that trip the genset's general circuit breaker.

The connection between *the measurements and visualization modules* is made by the CAN bus communication, which allows the interconnection of additional modules, allowing the expansion of the CEM7 device.

1.2.d. With the bus CAN these additional modules can be added:

- Programming timer
- Telesignal device
- J1939 device
- Repetitive display
- CAN USB
- CAN/232 + LINE MODEM
- CAN/232 + GSM MODEM
- CAN/232 + GSM MODEM/GPS POSITIONER
- CAN/485 (MODBus)
- CAN/LAN
- CAN/LAN /MODBus IP)
- Zero suppressor
- ATS control panel with CEC7 controller



2. VISUALIZATION MODULE FRONT VIEW

THE VISUALIZATION MODULE HAS A BACKLIT DISPLAY AND DIFFERENT LED'S TO INDICATE THE CEM7 DEVICE STATUS. DIFFERENT PUSH BUTTONS ALLOW THE USER TO COMMAND AND PROGRAM THE CEM7.

2.1. Display

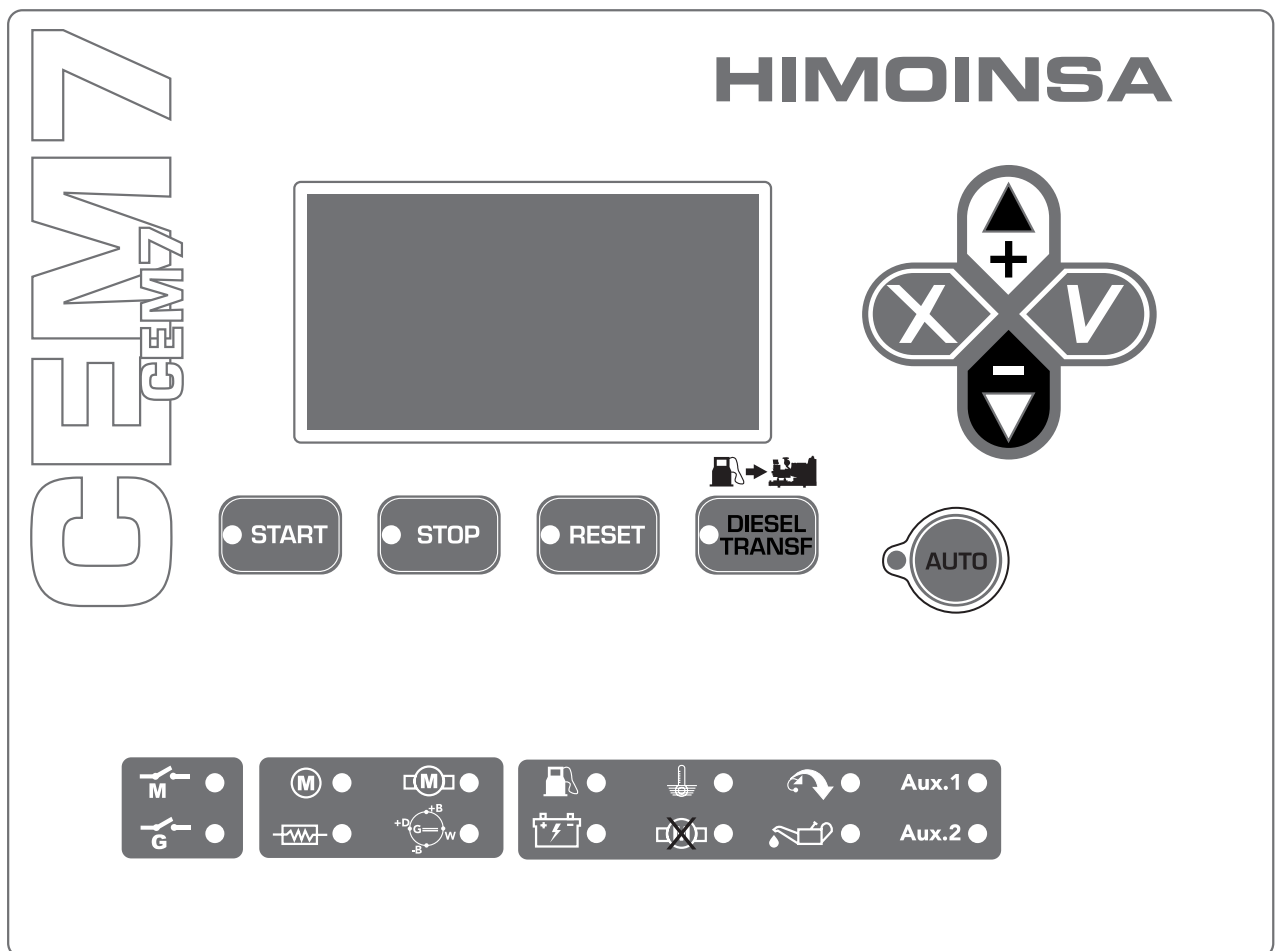

- Backlit graphic display of 128x64

NOTE: The display comes in low consumption (off the backlighting) after 10 minutes without any detectable pulse on the keyboard.

- Control board push buttons.
 - Operating mode buttons.
 - Command buttons.
 - Display buttons.
- Data LED's.
 - ENGINE status LED's.
 - ALARMS LED's.
 - CONTACTORS status LED's CEM7+CEC7







2.2. PULSADORES DE LA CENTRAL

2.2.a. Command buttons.

	<p>Automatic mode: The CEM7 device monitors the status of the generating set and controls its working process and the programmable inputs.</p> <p>Manual mode: The user controls the device.</p>	<p>LED on: Automatic mode running.</p> <p>LED flashing: Automatic mode blocked.</p> <p>LED off: Manual mode running.</p>
---	--	---

2.2.b. Pulsadores de comando de la central

	<p>Start engine push button (manual mode only). It administers the start with a single press. LED on: Engine starting</p>
	<p>Stop engine push button (manual mode only). Press once, the engine stops and a cooling phase begins. Press twice, the engine stops immediately. LED on: The engine is in stopping phase (with or without cooling-down)</p>
	<p>Reset push button. Allows the user to acknowledge and clear the alarm condition LED flashing: There are alarms to check up. LED on: Active alarms.</p>
	<p>Transfer fuel pump push buttons. In manual mode, this button activates the transfer pump if the fuel level is under the programmed levels. LED on: Fuel transfer pump working.</p>

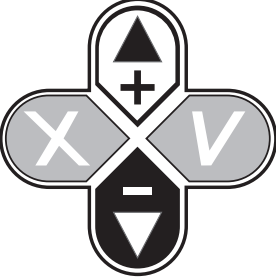

2.2.c. Display buttons.

	<p>Confirmation button (V): Allows access to menu, validates and store the entered data.</p>
	<p>Cancellation button (X): Go back in the menu and cancels the entered data.</p>
	<p>Up button (+): Moves along the selection displays and maintenance menus, also increases the programmed values.</p>
	<p>Down button (-): Moves back in the selection display and maintenance menus, it also reduces the programmed values.</p>







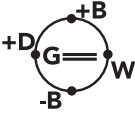

2.3. DATA LED's

2.3.a. ENGINE status LED's.

	Engine started	On: Engine running detected. Off: Engine stopped.
	Pre-heating	On: Pre-heating function activated. Off: Pre-heating function not activated.
	Engine starting	On: Engine starting activated. Off: Engine starting not activated.
	Battery charge alternator status	On: The voltage supplied by the battery charge alternator is detected when the engine is running. Off: Engine stopped or started without voltage signals in the battery charge alternator.

2.3.b. ALARMS LED's.

	Fuel storage	On: alarm caused by analog sensors. Flashing: alarm caused by digital inputs. Off: No alarms.
	Battery levels	
	High temperature	
	Starting failure	
	Overspeed	
	Low oil pressure	
Aux.1	Aux1 (Free to programme)	
Aux.2	Aux2 (Free to programme)	



NOTE: See alarms section for more details.



2.3.c. CONTACTORS status LED's (CEM7 + CEC7).

These LED's will be on only when the transfer switch is connected. The M & G symbols in the front panel will only be active when the switching controller is connected.

See annex II: Starting option when mains voltage fails (CEM7 + CEC7).

	●	Mains contactor status	On: contactor activated. Flashing: alarm, confirming the contactor is activated. Off: Contactor deactivated.
	●	Generating set contactor status	

2.3.d. PASSWORD

The CEM7 device has 2 passwords levels of four digits to avoid non authorised access. Those different access levels are:

- **User** access (password stored: 1111). The user access level allows the entrance in the CEM7 main menu.
- **Maintenance access:** (password stored: 1911). The maintenance access level allows the use of the parameter programming option in the main menu.

The passwords in the CEM7 can be changed by the user in the main menu. The user can change the passwords in the user access level, as well as in lower access levels.

NOTE: To enter new passwords, see annex II. Enter passwords.



3. OPERATIONAL MODES

3.1. Manual Mode

In the **manual mode**, the user operates the controller using the front panel of the visualization module. The engine is manually started and stopped using the **START** and **STOP** buttons.

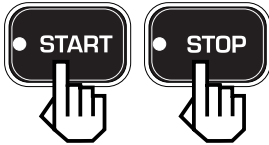

Pushing the **START** button activates the engine starting process (without deactivating the mains contactor CEM7 + CEC7)). Pushing the **STOP** button once stops the engine, with a cooling down cycle. Pushing the **STOP** button twice stops the engine immediately, without cooling down phase.

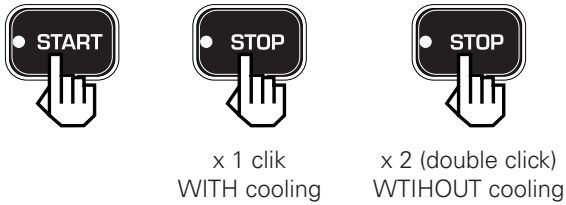

NOTE: In **manual mode**, the safety devices of the controller remain activated, and if an anomaly is detected, an alarm status is triggered.
In **manual mode**, the device ignores all external requests previously programmed (Timer, ATS signal, etc...).

3.2. Automatic mode

In **automatic mode**, the CEM7 constantly controls the genset operation. In some situations, that can be programmed to supply power, the controller starts the generator set activating the genset contactor.



As programmable starting conditions of the genset with the activation of contactors, could be considered:

- External start
(Programming table parameter 10).
- Start controlled by timer.
(if it is included programming timer)
- Forced start
(Programming table parameter 12 y Regulations table parameter 25).

As programmable starting conditions of the genset without the activation of contactors, could be considered:

- EJP Rate change notice (CEM7+CEC7)
(Programming table parameter 7).
- Engine test (CME7+CEC7)
(Programming table parameter 11).

Also, in **automatic mode** allows the management of starts using external devices, (PC, modem, or visualization modules or commutation devices).



3.3. Interruption of modes

Pressing the Auto button for 5 seconds will lock the automatic operational mode. This blocking function does not allow the change of the operational mode and it is indicated by a flashing led in the Auto button. To deactivate the automatic interruption mode and allow the change of operational modes, the Auto button has to be pressed for 5 seconds.

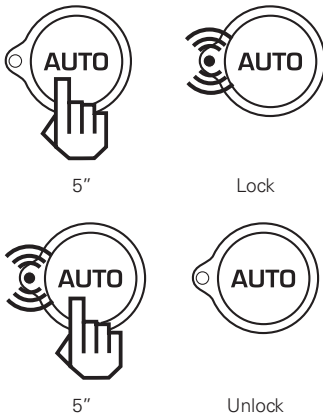



4. WORKING MODE

4.1. Starting the engine

THE ENGINE WORKS IN THE FOLLOWING WAY, ONCE THE CONTROLLER DETECTS AN ACTIVATION CONDITION:

- 1. Delay in the starting:** Once an activation condition is detected and before going on with the engine starting process (automatic mode), a delay in the engine starting can be programmed (**Times table parameter 3**) (CEM7 +CEC7).
- 2. Engine pre-heating phase.** The control board activates the pre-heating output for a programmed time. (**Times table parameter 4**)
- 3. Engine energizing (run signal):** The engine run signal is made by means of the PC (B+) output from the measurements module. The output allows a no-excitation Stop (energise to-run) or an excitation stop (energise to-stop) (**Times table parameter 12**). This output is configurable. (**Regulations table parameter 18**).
- 4. Engine starting (START).** For a programmed period of time (**Times table parameter 5**), the starting output of the measurements module is activated, waiting to detect, at least, one of the programmed starting conditions. The possible engine starting conditions could be:
 - **Generator voltage.** (**Regulations table parameter 19**). The engine would be considered started (running) when its voltage exceeds a given value. (**Thresholds table parameter 20**).
 - **Alternator voltage:** (**Regulations table parameter 20**). The engine would be considered started (running) when the battery charge alternator voltage exceeds a given value. (**Thresholds table parameter 21**).
 - **Pick up frequency** (**Regulations table parameter 21**). The engine would be considered started (running) when the pick up frequency (**Thresholds table parameter 22**) exceeds a given value. To activate the pick up calculation through the engine ring gear, the number of teeth of the gear must be introduced (**Thresholds table parameter 24**); In case the number of teeth is "0", the frequency of the pick up will be calculated through the generator frequency as per the equivalence-ratio 50Hz/1500 rpm or 50Hz/3000 rpm and 60 Hz/1800 rpm. (**Regulations table parameter 26**).
 - **Low oil pressure.** (**Regulations table parameter 22**). It is not advisable to use the low oil pressure signal as a way to detect if the engine is working, but it is useful as a protection, in order to avoid engaging the starter while the engine is running. Exception for this "Engine Start Detection" option Exceptions for this "Engine Start Detection" option are engines which have self-powered sensors.If in the programmed time the starting of the engine is not detected, the control board waits for a short time

(**Times table parameter 2**) before attempting a new start. The Start failure alarm will be raised after a specified number of attempts without detecting any starting condition (**Times table parameter 1**).

In the starting cycle, the excitation of the battery charge alternator is activated through the **D+** output temporarily (**Times table parameter 8**). Once the excitation of the alternator is finished, the measurements module checks if the battery charge alternator is working properly. The battery charge alternator failure alarm is raised in case of an output failure. (**Alarms table parameter 10**).

- **Genset stabilization:** Once any of the starting conditions is detected, the controller waits for a programmed stabilization-time of the generator output, before monitoring output parameters.
- **Nominal condition.** Once the stabilization of the engine is reached, the next step is the checking of the signal produced by the generator. In this way, the quality of the signal produced by the generator set is monitored (voltage levels, frequency...).





START OPERATING PROCESS. PRACTICAL EXAMPLE.

NOTE: Before initiating the stop cycle, it is advisable that the main genset circuit breaker be switched OFF.

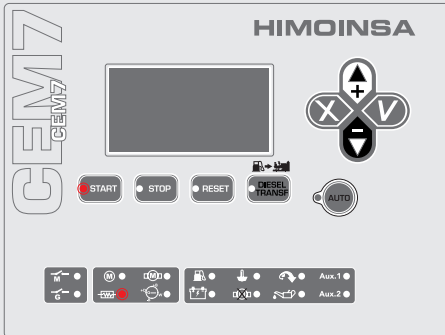
OPERATING: When **START** button is pressed, the starting cycle will be initiated, and the **START** LED will be on. At the same time, if the engine has glow plugs, the PR output will be activated, and the appropriate LED () will be on during the programmed period of time.



After this period of time, the PR outlet becomes inactive, the LED () will turn off and, soon afterwards the PC positive contact output becomes active and 0,5" later the ARR crank output also becomes active (). This output remains activated until any of the engine started conditions is detected.

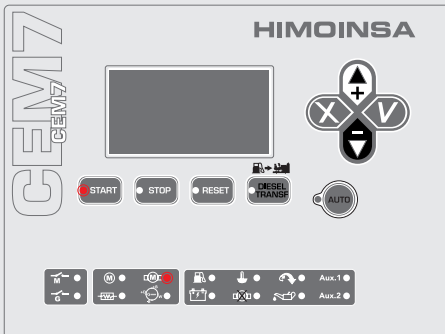

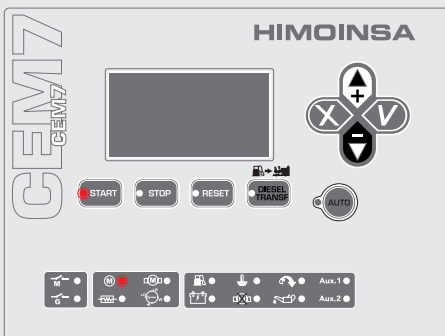

Once the engine is detected as started, the LED () turns on. Then the starting cycle is finished and the **START** button switches off.



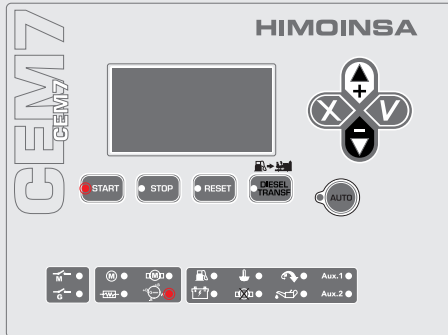

The LED controlling the voltage of the battery charge alternator () lights when the value of the voltage given by the alternator is higher than the voltage threshold previously programmed.



If during the starting cycle, the engine is not detected as started, after 5", the ARR output becomes inactive and its related LED switch off (). Afterwards and automatically the controller will begin a new starting attempt, repeating a new cycle without any need to push **START** (4 cycles by default). Having all the attempts exhausted without any effective start, the controller will trigger the **START FAILURE** alarm.

To stop the starting cycle, just press the **STOP** button.

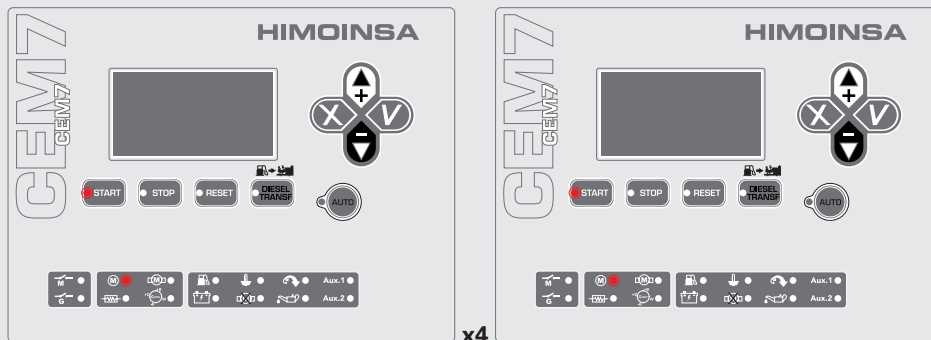

NOTE: readings about the engine condition are shown on the display, and details about the start operating process can be visualized. The sequence being as follows:

- Genset: Stop
- Genset: Starting
- Genset: Started
- Genset: Stabilized
- Genset: Loading

NOTE: The starting process in an automatic system by means of timer, ATS signal, etc... works in the same way as a starting cycle in manual mode.



4.2. Engine stop

The stop engine process in the automatic-mode is done according to the following process:

- 1. Engine cooling down:** Once all loads are disconnected, the engine will continue to run for some time during the cooling time (**Times table parameter 11**). Under particular situations the alarms of the controller may be programmed (**Alarms table parameters 3, 6, 9...**) to stop immediately without the cooling down of the engine.
- 2. Engine stop.** After the cooling down of the engine, the PC output of the measurements module is switched off or on, according to the programmed stop configuration (**Regulations table parameter 18**). As a condition of the engine stop, it can be selected:
 - **Generator voltage.** (**Regulations table parameter 19**). The engine would be considered stopped when the generator voltage is lower than its starting threshold (**Thresholds table parameter 20**).
 - **Alternator voltage:** (**Regulations table parameter 20**). The engine would be considered stopped when the battery charge alternator voltage is lower than the starting threshold (Thresholds table parameter 21).
 - **Pick up frequency.** (**Regulations table parameter 21**). The engine would be considered stopped when the pick up frequency is lower than its starting threshold (**Thresholds table parameter 22**). To activate the pick up calculation through the engine ring gear, the number of teeth of the gear must be introduced (**Thresholds table parameter 24**); In case the programmed number of teeth is "0", the frequency of the pick up will be calculated through the generator frequency as per the equivalence-ratio 50Hz/1500 rpm, 50Hz/3000 rpm or 60Hz/1800 rpm. (**Regulations table parameter 26**).
 - **Low Oil Pressure.** (**Regulations table parameter 22**). The condition of Low Oil Pressure considers the engine stopped when it detects that the sensor is closed. Exception for this "Engine Start Detection" option is SCANIA engines and also the sensors which have self - electrical supply.

All the programmed stopping conditions must be present for an interval of time (**Alarms table parameter 71**) to consider the engine as stopped. If during 90 seconds is still detecting any condition engine running, the Stop Failure alarm will be activated.



STOP OPERATING PROCESS. PRACTICAL EXAMPLE

NOTE: Before initiating the stop cycle, it is advisable that the main genset circuit breaker be switched OFF

The genset can be stopped in several ways:

- 1. Manual:** Press **STOP** button once. The genset stops with cooling down.
- 2. Manual:** Press **STOP** button tow times. The genset stops without cooling down.
3. Place the activation key of the board in "O" position. The genset stops without cooling down.
- 4. Automatic:** The genset stops with cooling down cycle after the deactivation of the command which automatically started the genset.

Sequence: Pressing the **STOP** button once, the stop cycle will start with the engine cooling process. The **STOP** button will light.

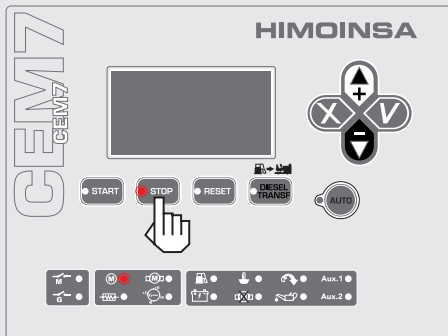

Once the cooling time is over the PC output is activated or deactivated, according the type of engine, to carry on with the stopping cycle. Then the **STOP** button and the LED (M) of started engine switch off.

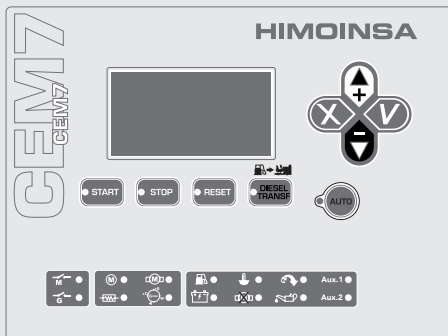

If after a period of time an engine running condition of "started engine" is detected, the control board will show in the display the **STOP FAILURE** alarm and the LED of the **STOP** button will light.

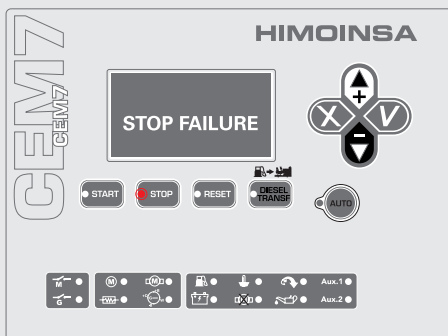



The LED controlling the voltage of the battery charge alternator () turns off when the value of the voltage given by the alternator is lower than the voltage threshold previously programmed. (4)

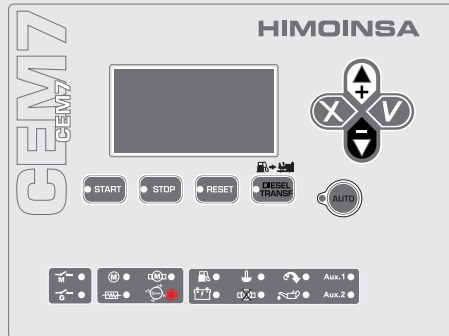

NOTE: Readings about the engine condition are shown on the display, and details about the stop operating process can be visualized. The sequence being as follows:

- Genset: Stabilized.
- Genset: Cooling.
- Genset: Stopping.
- Genset: Stop.



4.3. Transfer fuel pump. (BTC, BTNA)

The transfer fuel pump function process can be activated in the CEM7 device by linking its working service to the BT relay from the measurements module. (**Regulations table parameter 4**). Once the transfer pump option is activated, its operation modes are as follows (**Regulations table parameter 1**):

- 1. Inhibited mode.** No transfer fuel pump functions can be considered
- 2. Manual mode:** the transfer pump is operated by pressing the diesel Transference button, provided that the fuel level is under the maximum threshold parameters (**Thresholds table parameter 19**)
- 3. Automatic mode:** the transfer pump becomes operative according to the minimum activation parameters (**Thresholds table parameter 18**) under which the relay BT is activated/energised and according to the maximum deactivation parameters (**Thresholds table parameter 19**), over which the relay BT is de-energised.
- 4. Control board mode** (Available for firmware versions 2.54 and lower of the controller): the transfer pump operation is carried out as follows:
 - When the controller is in automatic or test-mode, the transfer pump is operated automatically.
 - When the controller is manual-mode, the transfer pump operation is carried out in manual mode.
 - When the controller is in a blocked-mode, the transfer pump operation is inhibited (CEM7 + CEC7).
- 5. Combined mode.** (Available for firmware versions 2.56 and higher of the controller).
 - The management of the transfer pump is carried out in the Automatic mode, but also allows the activation of the BT relay by pushing the diesel key
 - Transf. The manual activation of the BT relay is joined by the maximum deactivation range (parameter ranges table 19).
- 6. Gauging system for the fuel tank:** For an accurate fuel level measurement (needed for the fuel pump and fuel level alarm functions) a calibration of the tank level sender must be done, by having access to both the minimum and maximum parameters of the level sender (Measurements table parameters 12 and 13). To adjust the minimum fuel level of the tank it must be recorded the parameter 12 of the measurement table with the level sender in its minimum position. To adjust the maximum fuel level of the tank, it must be recorded the parameter 13 of the measurement table with the level sender in its maximum position.

4.4. Pre-Heating

The engine pre-heating allows 2 activation modes:

1. Assigning to the BT relay of the measurement module, the pre-heating working process (**Regulations table parameter 4**).
2. Assigning to any of the 3 programmable outputs of the measurement module the pre-heating working process (**Programming table parameters 1 to 3**), provided the BT relay of the measurement module is in charge of the fuel transfer pump functions. (**Regulations table parameter 4**).

The following functions are executed by the engine pre-heating:

- Under an adjustable engine temperature threshold (**Thresholds table parameter 29**), the pre-heating system is activated.
- Under an adjustable engine temperature threshold (**Thresholds table parameter 28**), the activation of the genset contactor is disabled and the low engine temperature alarm rises (**Alarms table parameters 73 to 74**).
- Over an adjustable engine temperature threshold (**Thresholds table parameter 30**), the pre-heating system is deactivated.



4.5. Battery charger alternator

The battery charge alternator is connected to the CEM7 device by means of the digital output **D+** and the analog input **DI** from the measurement module.

The CEM7 can be configured to trigger an Alternator Voltage alarm (**Alarms table parameter** 10 to 12) if it is detected a low voltage level provided by the battery charge alternator through the **DI** analog input from the measurement module.

Two working modes of the battery charge alternator can be selected (**Regulations table parameter** 3)

4.5.a. Alternator mode

The battery charge alternator of the CEM7, configured as alternator mode, energizes the alternator, by means of a triggering pulse of configurable duration (**Times table parameter** 8). This is done during the engine starting process through the **D+** output from the measurement module. When this pulse ends, the control board test the voltage produced by the battery charge alternator.

The voltage produced by the battery charge alternator can be used as starting engine condition (**Regulations table parameter** 20). For that purpose, the CEM7 expects to measure, through the **DI** analog input, voltage values exceeding the alternator voltage detection threshold (**Thresholds table parameter** 21).

The CEM7 device can be configured to raise an Alternator Voltage alarm (**Alarm table parameter** 10 to 12) if it is detected a low voltage level provided by the battery charge alternator through the **DI** analog input from the measurement module. (Only if the alternator mode is configured).

4.5.b. Dynamo mode

The battery charge alternator of the CEM7, configured as dynamo mode, excites the alternator with a continuous triggering pulse by means of the **D+** output from the measurement module, as long as the engine stands in starting phase or already started.

The device, configured in dynamo mode, can not use the voltage measured through the analog input **DI** to detect engine started condition.

The CEM7 device can be configured to raise an Alternator Voltage alarm (**Alarm table parameter** 10 to 12) if it is detected a low voltage level provided by the battery charge alternator through the **DI** analog input from the measurement module. (only if the alternator mode is configured).

4.6. Start /stop key

The start/stop key in "on" position, supplies power to the CEM7 (measurements and visualization module).

The start/stop key in "stop" position, performs a controlled stopping of the engine if it was running; once the engine is stopped, its power from the CEM7 controller gets disconnected.



4.7. Start-up due to load demand (CEM7 + CEC7)

DESCRIPTION:

This option allows automatic start-up and load activation of the generating set depending on the mains power consumed.

The start-up will be executed according to the programming, considering the maximum power (KW) that may be consumed from the mains in a certain time period; once the generating set has started up, the system executes the change to genset power, leaving the mains load-free.

Once the load in the installation is below the threshold programmed for reactivation and the time period has expired, the system will again transfer the installation's load to the mains and the genset will begin its power-down cycle.

PROGRAMMING:

The generating set will start up taking over the load, when a mains power consumption greater than a limit programmed by a parameter is detected (**Thresholds table parameter 34**).

The genset will remain in operation until the average power consumption decreases to below a limit programmed by a parameter (**Thresholds table parameter 35**).

During both start-up and power down of the genset due to load demand, the condition must be validated during a programmable time period (**Times table parameter 27**).

On the CEM7 controller, the start up due to load demand function is only enabled in Automatic Mode and when it is associated with a CEC7 switch.

NOTE: Starting from controller versions of firmware: Display 3.20/ Sizes 2.50

4.8. Electronic protection (overload and short-circuit)

DESCRIPTION:

Electronic protection is a characteristic that allows for the activation of an output on the controller when the overload and short-circuit alarm is activated.

This function makes it possible to deactivate the genset's general circuit breaker through the trip coil.

We must first programme the threshold and the alarms to set the characteristics of the electronic protection (*Thresholds table parameters 7 and 8*) and (**Alarms table parameter 28, 29 and 30** for the over-loading and parameters 58 and 60 for the short-circuit).

When the overload and short-circuit alarms are activated and awaiting notification, the output assigned to this function remains active.

PROGRAMMING:

The potential outputs that may be assigned to this function are:

- The BT relay of the measurements module (**Regulations table parameter 4**)
- Any of the programmable outputs of the measurements module (*Programming table 1 to 3*).



5. INPUTS AND OUTPUTS

The digital inputs of the CEM7 device, with specific functions as well as the programmable ones, have associated a stabilization time (**Times table parameters** 15 to 24) which requires the values of the inputs to be stable for a period of time.

Likewise, all the inputs of the control board can be configured to be active or not active; with contact closed to earth (**Regulations table parameters** 5 to 15).

The status of the inputs and outputs of the CEM7 can be visualized from the menu **MAIN → 1. Inputs/Outputs**. From this screen, the status of the digital inputs and outputs are displayed.



IN: Input
OUT: Output
Input /Output index. Orderly of the 13 to the 1.
The following characters show the detection of the **active input**:

- R:** Fuel Reserve (FR).
- B:** Low oil pressure. (LOP)
- A:** High temperature. (HCT)
- N:** Coolant level.(CL)
- X:** Programmable input 4. (default value, external start). (ES)
- I:** Programmable input 5. (default value, start disabling). (SD)
- P:** Emergency stop. (EMS)
- 1:** Programmable input 1.
- 2:** Programmable input 2.
- 3:** Programmable input 3.
- S:** Stop button.
- M:** Start key.

The following characters show the detection of the **active output**:

- A:** Active alarm.(AL)
- M:** Engine started.(SE)
- 1:** Programmable output 1. (OUT1)
- +**: Battery charge alternator (D+)
- 2:** Programmable output 2. (OUT2)
- 3:** Programmable output 3. . (OUT3)
- r:** Mains contactor.(MCC, MCNC, MCNO)
- g:** Generating set contactor. (GCC, GCNC, GCNO)
- B:** Fuel transfer/pre-heating. (FPC, FPNA)
- 4:** Programmable output 4.
- R:** Pre-heating/excitation stop. (PH)
- P:** De-excitation stop/excitation stop. (START)
- C:** Controller fitting.



Pressing UP/DOWN buttons, the user gain access to the **analog inputs** readings.

A N A L O G S		I N P U T S	
N C	0 . 0	P A	0 . 0
T M	0 . 0	A A	0 . 0
D I	0 . 0 V	V B	0 . 0 V

The value of the resistive **analog inputs** is found in Ohms and the value of the voltage **analog inputs** is given in Volts. The inputs that can be seen are:

- **FL:** Fuel level.
- **OP:** Oil pressure.
- **ET:** Engine temperature.
- **AA:** Analogic Auxiliary.
- **DT:** Dynamo tension.
- **BV:** Battery voltage.



5.1. Digital Inputs

5.1.a. Presets inputs

The measures module in the CEM7 has 5 digital inputs, whose working process is already pre-set.

Fixed inputs show the following situations:



High temperature (HCT)

Digital signal reporting to the controller that the thermostat of the engine has detected a failure and sets on an alarm due to the engine high temperature (**Alarm table parameters 1 to 3**).



Low oil pressure (LOP)

Digital signal reporting to the controller that the engine pressure switch has detected a failure and sets on an alarm due to the low oil pressure (**Alarm table parameters 4 to 6**).



Coolant level (CL)

Digital signal reporting to the controller that an alarm triggered due to low coolant level (**Alarms table parameters 16 to 18**).



Emergency stop (EMS)

Digital signal reporting to the controller that an immediate stop without cooling must be done.



Fuel reserve (FR)

Digital signal reporting to the controller that an alarm has been generated due to a failure in the fuel reserve. (**Alarm table parameters 19 to 21**).

5.1.b. Programmable inputs

The CEM7 measures module has 5 digital inputs whose operation can be programmed.

The purpose **programmable** inputs can be configured to take the following behaviour:



Rate notice signal (EJP1)

This function only works when the CEM7 + CEC7 functions in automatic mode.

The input configured as rate notice (**Programming table parameter 7**) starts the genset after activating the relating input and once a programmed time is over.

(**Times table parameter 9**). The rate notification is considered finished when the EJP1 input is deactivated and a stop with engine cooling is produced.



Rate change notice signal (EJP2)

This function only works when the CEM7 functions in automatic mode.

The input configured as rate change notice signal (**Programming table parameter 8**) activates the genset contactor, provided no abnormal situation is detected in the genset.



Start disabling signal (SD / INP5)

This function only works when the CEM7 functions in automatic mode.

The input configured as start disabling signal (**Programming table parameter 9**) does not allow the starting of the genset under any condition, excepting manual override starting (**Programming table parameter 12**) configured as a high priority option. (**Regulations table parameter 25**).



External start signal (ES / INP4)

This function only works when the CEM7 functions in automatic mode

The input configured as external start (**Programming table parameter 10**) forces the starting of the genset if it is working in automatic mode, provided that no of the following start disabling conditions are present:

- The start disabling (SD) input is not activated.
- The device status is not blocked by the programming timer.



Test signal (TEST)

This function only works when the CEM7 functions in automatic mode or with CEM7+CEC7.

The input configured as test (**Programming table parameter 11**) allows the checking of the genset without interfering in the mains.



Manual Override (MFOR)

This function only works when the CEM7 functions is in automatic mode.

The input configured as override (**Programming table parameter 12**) meets the fire safety regulations and accordingly the genset working can not be interrupted under any condition except overspeed and emergency stop (be it alarm, external disabling input or programmed blocking). Three manual override working modes can be configured (**Regulations table parameter 25**):

- **0:** Manual override disabling. The manual override process is not managed, despite of having an associated programmable input.
- **1:** Starting due to mains power failure (CEM7+CEC7). When the manual override input is activated, there is a time in which is expected the genset to start due to any programmed condition (mains signal alarms, mains contactor failure, external start...). In automatic mode, to stop the functions of the device, it is not enough the mains voltage alarm disappears but must be deactivated the manual override input.
- **2:** Manual override starting. The genset starts immediately when the manual override input is activated, without awaiting any other starting condition. To stop the device, it is necessary to change to manual mode and stop the controller with the pushing buttons.

5.1.c. Programmable alarms (AL1, AL2 and AL3)

There are 3 free to be programmed alarms (**Programming table parameters 13, 14 and 15**) that can be associated to any of the programmable inputs whose function is to provide additional alarms to the controller. Its working mode is programmable. (**Alarms table parameters 79 to 87**). These alarms can be programmed in operation mode and in the text that shows in the activated display.

5.1.d. Programmable alarms (AL4 and AL5)

There are 2 additional programmable alarms available (**Programming table parameters 22 and 23**) that may be associated with any of the programmable inputs and whose purpose is to provide the additional alarms controller with configurable operation (**Alarms table parameter 111 to 116**).

These alarms may be programmable in both activation mode and in the next shown on the display when they are activated.

NOTE: Starting from central versions of firmware: Display 3.20/sizes 2.50

5.1.e. Selection of parameters set (S1 and S2)

There are two additional sets of parameters that may be enabled through any of the programmable inputs (**Programming table parameters 16 and 17**).

Activating the selection of a set of parameters input enables the values with which the controller operates (Selector table).



5.2. Analogic Inputs

The CEM7 device has 5 **analog inputs** to measure the several engine working values. Such **analog inputs** will allow to portray the engine working process and display its condition, setting on alarms if required, being its working already pre-set. The alarms caused by the **analog inputs** does not stop the engine, they are only a warning. By default, the alarms raised by **analog inputs** do not stop the controller (engine warnings), but can be configured to produce the stop, with or without cooling.

The CEM7 controller carries out a continuous checking of the installed analog sensors, showing in the visualization module display the value of the readings made.

5.2.a. Fuel level (FL)

The analog fuel level input indicates the amount of fuel left in the tank. To fit its working mode, the maximum fuel level in the tank must be set (**Measurements table parameter 13**), and the same with the minimum fuel level. (**Measurements table parameter 12**). To adjust view section 4.3.

In the same way, a minimum fuel-in tank threshold (**Thresholds table parameter 25**) can be fixed, and it will raise an engine warning (**Alarms table parameter 55 to 57**) when the fuel level is detected under such limits.

When the BT relay from the measurement module is programmed to control the functions of the fuel transfer pump, it will start the pump to transfer fuel to the tank if the fuel level is detected under the minimum limits (**Thresholds table parameter 18**). The fuel pump is deactivated when the fuel level is detected over the programmable threshold (**Thresholds table parameter 19**). Working the fuel pump in manual mode, the threshold disables the activation of the fuel transfer pump except in case of the user intervention.

5.2.b. Oil pressure input (P)

The analog fuel pressure input allows supervising the engine oil pressure value. The controller allows the connection of sensors to such analog input (Analogics sensor table).

By programming a threshold, a minimum oil pressure limit can be set (**Thresholds table parameter 26**) in order to raise an engine warning (**Alarms table parameter 52 to 54**) when the pressure is detected under such limit.

5.2.c. Engine temperature input (T)

The analog engine temperature input allows supervising the engine coolant temperature value. The controller allows the connection of sensors to such analog input (Analogic sensors table). By programming a threshold, a maximum engine temperature limit can be set (**Thresholds table parameter 27**) in order to raise an engine warning (**Alarms table parameter 49 to 51**) when the temperature is detected over such limit.

In the same way, if the pre-heating function is programmed (by means of the BT relay, if it is programmed to regulate the fuel pump, or any other programmable input), the analog temperature inputs allow to regulate the activation of the pre-heating cycle.

5.2.d. Alternator voltage input (DI)

The analog voltage input allows supervising the value of the voltage generated by the genset. Such an input is used to diagnose the possible abnormal working of the alternator, if this detects a low voltage level while the engine is on work. Under such condition an alarm signal of the battery alternator will be triggered. (**Alarms table parameter 10 to 12**).

In that way, the voltage can be programmed to detect a starting condition (**Regulations table parameter 20**) by means of setting an alternator voltage threshold for started engine (**Thresholds table parameter 21**), only if it is not configured as dynamo mode (**Regulations table parameter 3**).

5.2.e. Auxiliary analog input (AA)

The auxiliary analog input is set by default, to monitoring the oil temperature.

Can be also assigned to any other measurement through a parametrizable curve (**Analogic sensors Table**).



5.3. Pick-up Input. (PCK1, PCK2)

The pick up input from the measurement module controls the rotation speed of the engine in revolutions per minute (rpm). To activate the pick up calculation through the engine ring gear, the number of teeth of the gear must be introduced (**Thresholds table parameter 24**). In case the number of teeth is "0" the controller is configured to have not available the pick up and the rotation speed will be calculated through the genset frequency as per the equivalence-ratio 50Hz/1500 rpm or 50Hz/3000 rpm and 60Hz/1800rpm or 60Hz/3600rpm. (**Regulations table parameter 26**).

The CEM7 device can be configured to trigger an overspeed alarm (**Alarms table parameters 22 to 24**) as well as an underspeed alarm (**Alarms table parameters 25 to 27**) taking into account the mechanical speed given by the pick up.

5.4. Digital outputs programmed

THE CEM7 DEVICE HAS 8 OUTPUTS OF SPECIFIC FUNCTIONS (2 OUTPUTS TO RELAY, 3 POWER OUTPUTS AND 3 DIGITAL OUTPUTS)

The working mode of those outputs is pre-established, though they can be configured.



Pre-heating output. (Power Output)

The pre-heating output (PR) of the CEM7 is an output connected to a high voltage short-circuitable driver (70A) in charge of regulating the glow plug heating procedure of the engine during the starting cycle. The activation time of the pre-heating output is configurable (**Times table parameter 4**). The pre-heating output can be also used to control the stop by excitation of engines with this kind of stop configuration (**Regulations table parameter 18**).



Engine starting output. (Power Output)

The engine starting output (ARR) of the CEM7 is an output connected to a high voltage short-circuitable driver (70A) which activates the starting of the engine. The activation of the engine starting remains until any programmed starting condition is detected (**Regulations table parameters 19 to 22**) during a maximum programmable time (**Times table parameter 5**).



Engine stop output. (Power Output)

The engine stop output (PC) of the CEM7 is connected to a high voltage short-circuitable driver (70A) which controls the stopping of the engine. The engine stop input allows the configuration of its working mode to control engines with 2 stopping modes (**Times table parameter 18**):

- **De-excitation stop:** The engine stop output configured as stop by de-excitation is activated 500ms after the pre-heating output is disabled and it is deactivated when the stop of the engine is ordered.
- **Excitation stop:** The engine stop output configured as stop by excitation is activated during a programmable time (**Times table parameter 12**) when the stop of the engine is ordered.
- **Excitation/ de-excitation stop:** The engine stop output configured as stop by excitation/de-excitation is activated 500ms after the pre-heating output is disabled and it is deactivated when the stop of the engine is ordered. Such output is used to enable the engine sensors. The pre-heating output will be the responsible of the stopping phase by means of the excitation stop cycle.



Fuel pump/pre-heating output. (relay output)

The fuel pump/pre-heating (BT) of the CEM7 is an output that can be configured (**Regulations table parameter 4**) to control the filling of the genset fuel tank with the fuel pump or the pre-heating process of the engine.



Battery charge alternator excitation output (D+). (digital output)

The D+ output of the CEM7 is in charge of exciting the battery charge alternator during the starting process. This output can be configured (**Regulations table parameter 3**) to produce a starting pulse (alternator mode) of a programmable time (**Times table parameter 8**) or to keep the alternator continuously excited (dynamo mode).



Genset contactor output. (Relay output)

The genset contactor output (GC) of the CEM7 controls the connection and disconnection of the installation to the genset.



Alarm output (AL). (digital output)

The alarm output (AL) is in charge of communicating the different status of the CEM7 device. The AL output is activated simultaneously with the flashing of the LED of the Reset button and the buzzer from the display module of the CEM7. This input monitors the following status of the CEM7 controller:

- **External start of the control board.** The alarm output of the device (AL) is activated for 5 seconds if it is detected a control board start ordered by a programmable input, associated to the AE mode.
- **Control board failures.** The CEM7 device is activated for a maximum programmable time (**Times table parameter 14**) if it is detected an active failure or a failure waiting to be acknowledged by the user. If the user presses once the Reset button, the AL output is deactivated. The failures that activates the AL output are suitable to the alarms which induce the engine stop as well as the warnings which do not stop the engines, excepting the ones raised by the quality of the mains signal:



Started engine output (SE). (Digital output)

The engine started (MA) output on the CEM7 controller is activated from the moment any running engine is detected, and it remains active while the engine is running. The started engine output (MA) deactivates when the engine stopping cycle starts. This process includes the cooling of the engine (**Times table parameter 11**) during the stopping cycle.

5.5. Programmable outputs

The CEM7 device has 3 programmable outputs whose working mode can be configured to indicate different controller status. (**programming table parameters 1 to 3**). The possible configurations are:

5.5.a. Inhibited output

The programmable outputs configured as inhibited output do not obey to any action or status, they remain constantly deactivated.

5.5.b. Output programmed by input status

The programmable outputs (Associate to a programmable input) configured as programmed by input status are activated when an associated input is detected.

As possible inputs configurations, can be found the following:

- Fuel level input
- Coolant level input
- Programmable input 1
- Programmable input 2
- Programmable input 3
- Programmable input 4
- Programmable input 5

5.5.c. Output programmed by alarm

The programmable outputs configured as programmed by alarm are activated when the device detects any activated alarm, associated to programmable outputs or that has not been yet checked by the user

As possible alarm configurations, can be found the following:

- Emergency stop
- Low oil pressure
- Battery charge alternator alarm
- High coolant temperature
- Programmable alarm 1
- Programmable alarm 2
- Programmable alarm 3
- Programmable alarm 4
- Programmable alarm 5
- Thermal protection alarm



5.5.d. Output programmed by function

The programmable outputs configured as programmed by function are configured to allow a function associated to an already used output. As possible functions of configurations, can be found the following:

- **Heater.** The output can function to activate the heater (glow plug) if the BT relay is programmed to control the fuel pump.

5.5.e. Output programmed by mode

The programmable outputs configured as programmed by mode are configured to indicate the working mode of the controller.

As possible mode configurations, can be found the following:

- Controller in **manual mode.**
- Controller in **auto mode.**

5.5.f. False load programmed output

DESCRIPTION:

This option makes it possible to activate a charging rack separate from the installation's load, in order to prevent the generating set from operating without a load or with low-load thresholds, so as to avoid excessive oil consumption in the engine and keep the engine functioning with an optimum load.

PROGRAMMING:

The programmable outputs configured as false load programmed outputs are activated when a genset power consumption lower than the programmed threshold is detected (**Thresholds table parameter 32**) for a set time (**Times table parameter 26**).

The outputs configured as false load programmed outputs are deactivated when the power consumption of the genset is greater than the programmed threshold (**Thresholds table parameter 33**) for a set time (**Times table parameter 26**).

Conditions for enabling the false load outputs are that the generating set contactor be active (CEM7 + CEC7) and the engine stable.

NOTE: Starting from central versions of firmwaare: Display 3.20/Sizes 2.50

5.6. Expansion programmable outputs

The CEM7 controller has 4 additional programmable outputs installed for the expansion of the Zero suppressor whose operation may be configured to indicate certain states (**Programming table, parameters 18 to 21**).

Of the 4 available outputs, 2 (**Programmable Outputs, 4 and 5**) connect directly to a panel and the other 2 (**Programmable outputs, 6 and 7**) must be requested as a special function.

The potential configurations that allow programmable outputs are the same as those explained in section 5.5.



6. CEM7 ALARMS

The CEM7 device provides a series of alarms whose working mode can be configured to perform actions or to be shown in the display of the visualization module.

The CEM7 distinguishes between anomalies which cause the stop of the engine (alarms) and errors which do not stop the engine (warnings).

When an alarm or warning is detected, the controller produces an acoustic alarm, at the same time the digital alarm output (AL) activates and the LED of **RESET** button flashes; this status will remain the same as long as the failure condition continues for a programmable period of time (**Times table parameter 14**).

The LED of the **RESET** button lights (and remains ON) when alarms or warnings are active or in need of acknowledgement. Pressing **RESET** button once allows the user to visualize a record of alarms and warnings that are active and needing to be acknowledged. The UP and DOWN buttons of the display are used to go back and forward in the failure record.

The record of warnings that are active or in need of acknowledgement has the following format:



- E:** Alarm

- A:** Warning

- N:** To be checked

- 1:** Number of position in the total record of errors

- 3:** Number of errors in the record

In the front panel of the control board there can be found LED's which indicate alarms detected by digital sensors (digital inputs) or by analog sensors (analog inputs).

NOTE: The alarms which cause the engine to stop are not auto-resetting, and they must be acknowledged and re-set by the user in order to be able to start the engine again, but only if the alarm does not remain active.

The alarms produced by analog inputs do not stop the engine; only trigger a warning according to the settings programmed by default. They need to be reset to erase them from the display, but only if the warning does not remain active. The fuel level alarm is an exception, as it is automatically reset.

6.1. Alarm operating process. Practical example

1. "EN" Alarm with engine stop
2. "AN" Warning that needs to be reset
3. "A" Warning automatically reset



1. "EN" Alarm with engine stop

- A. When an alarm is detected, the controller produces an acoustic signal, the LED of the **RESET** button flashes, the display blinks and the appropriate digital alarm output (AL) is activated. In this case the engine stops.
- B. The acoustic alarm is interrupted by pressing once the **RESET** button. The **RESET** LED turns into fixed light and the display (which stops flashing) shows the kind of alarm. i.e.: Active alarm "EN" High coolant temperature.
- C. To solve the alarm problem: In this example the temperature of the engine must be reduced when the engine stops. Check the coolant level of the engine to detect the cause of the failure. Once the alarm is no longer active "N" it will be possible to reset it by pressing **RESET** button and the engine can be restarted.

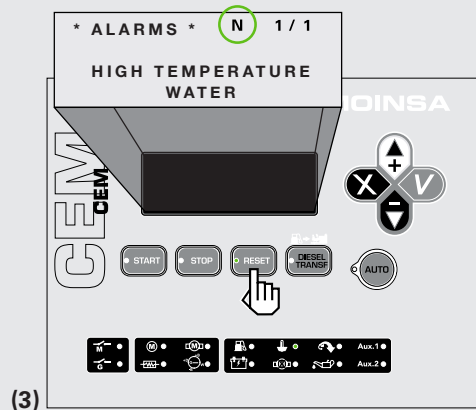
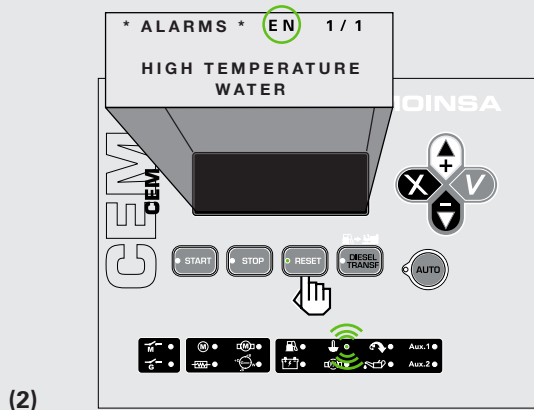
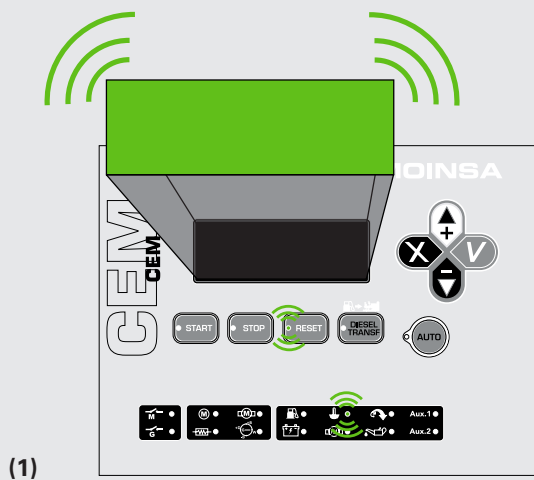



2. "AN" Warning that needs to be reset

- A. When an alarm is detected, the controller produces an acoustic signal, the LED of the **RESET** button flashes, the display blinks and the appropriate digital alarm output (AL) is activated.
- B. The acoustic alarm is cancelled by pressing once the **RESET** button. Once the **RESET** LED turns into fixed light and the display (which stops flashing) shows the kind of Active warning "AN"
- C. To solve the warning problem: In this case, stop the engine, if we consider so, to check the cause of the fault indicated. Once the warning is no longer active, "N" will appear in the display and it will be possible to reset it by pressing **RESET** button.

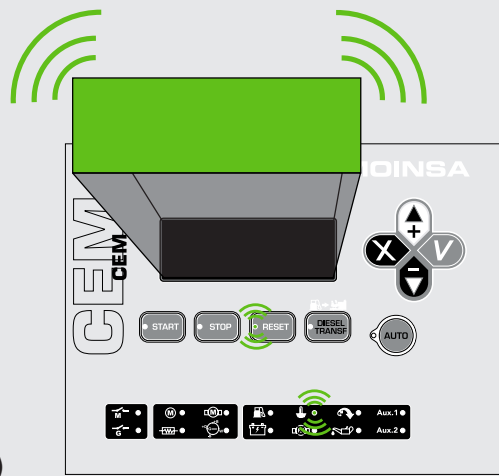

(1)

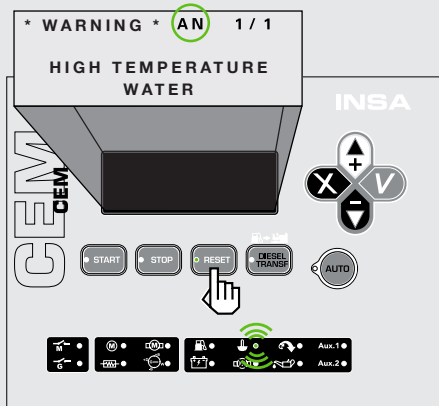

(2)

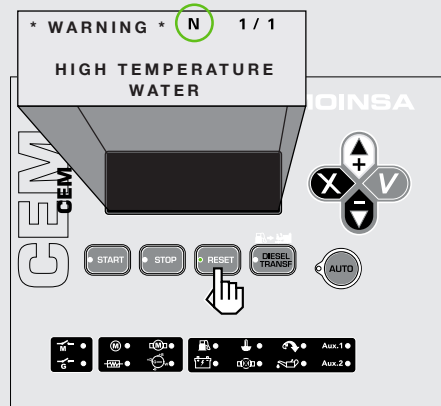

(3)



3. "A" Warning automatically reset

- A. When an alarm is detected, the controller produces an acoustic signal, the LED of the **RESET** button flashes, the display blinks and the appropriate digital alarm output (AL) is activated.
- B. The acoustic alarm is interrupted by pressing the **RESET** button once. The **RESET** LED turns into fixed light and the display (which stops flashing) shows the kind of warning. Warning "A"
- C. This kind of warning is automatically reset as long as the nominal conditions of working are restored. It is focused on the type of alarms related to fuel level (in default programming) and the alarms related with the mains threshold (CEM7+CEC7).

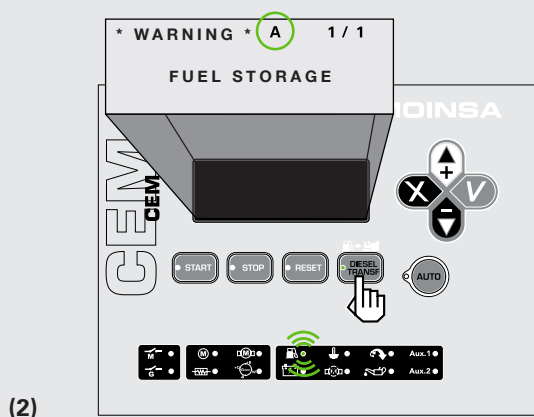
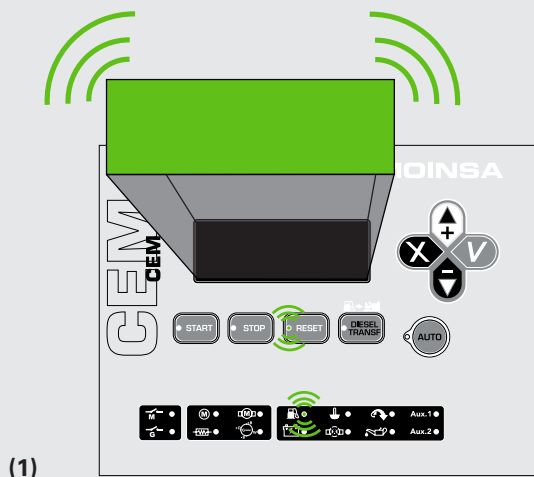













6.2. ALARMS

THE ALARM AND THE ACTIVE WARNING LIST CAN BE GROUPED IN THE FOLLOWING WAY: (ACCORDING THE MANUFACTURER DEFAULT SETTINGS)

6.2.a. Engine alarm

Description	Led in the front panel	Type	Action
High coolant temperature	 LED flashes	Alarm	Immediate engine stop with no cooling
Low oil pressure	 LED flashes	Alarm	Immediate engine stop with no cooling
Emergency stop		Alarm	Immediate engine stop with no cooling
Battery charge alternator failure (engine running)	 LED off	Warning	Engine does not stop
Start failure	 LED flashes		
Low coolant level		Alarm	Immediate engine stop with no cooling
Fuel storage	 LED flashes	Warning	Engine does not stop
Overspeed	 LED on	Alarm	Immediate engine stop with no cooling
Loss of speed		Alarm	Engine stop with cooling
Low battery voltage	 LED on	Warning	No stop
High coolant temperature by sensor	 LED on	Warning	Engine does not stop
Low oil pressure by sensor	 LED on	Warning	Engine does not stop
Low fuel level by sensor	 LED on	Warning	Engine does not stop
Unexpected shutdown			
Stop failure			
Low engine temperature		Warning	Engine does not stop
Genset voltage drops		Alarm	Engine stop with cooling



6.2.b. Genset alarms

Description	Type	Action
Overload	Alarm	Engine stop with cooling
Genset voltage asymmetry	Alarm	Engine stop with cooling
Maximum voltage of the genset	Alarm	Immediate engine stop with no cooling
Maximum genset frequency	Alarm	Immediate engine stop with no cooling
Erroneous phase sequence of the genset	Alarm	Engine stop with cooling
Inverse power	Alarm	Engine stop with cooling
Short circuit	Alarm	Engine stop with cooling
Minimum genset voltage	Alarm	Engine stop with cooling
Minimum genset frequency	Alarm	Engine stop with cooling

6.2.c. Programmable alarms and inputs

There are three programmable alarms that can be associated with engine alarms and be indicated by the LED's Aux 1 and Aux 2 of the display



6.3. Alarm description

Description	Type	Action
Related with programmable inputs	Alarm	According to configuration

All alarm excepting the not programmable, they can be configured in the following way:

to be carried out:

Never.
Always.
During the engine start.
From the started engine condition
From the engine nominal condition

to carry out one of the following actions:

No actions to be performed (warning)
Stop with engine cooling
Immediate engine stop

Will be highlighted in each of the alarms its configuration by default.

**High Coolant temperature**

The high coolant temperature alarm of the CEM7 is associated to the specific high coolant temperature digital input (HTC). The status of such input must be validated during a stabilization time (**Times table parameter 17**) before the high coolant temperature alarms triggers.

It can be configured as normally open or normally closed (**Regulations table parameter 7**).

The high coolant temperature alarm can be configured (**Alarms table parameter 1**) to be detected: Always

A stabilization time can be associated to the high coolant temperature alarm (**Alarms table parameter 2**) to delay the moment in which the alarm conditions are verified.

This alarm has been configured (**Alarms table parameter 3**) to carry out: the immediate engine stop.

**Low oil pressure**

The low oil pressure alarm of the CEM7 is associated to the specific low oil pressure digital input (LOP). The status of such input must be validated during a stabilization time (**Times table parameter 16**) before the low oil pressure alarm triggers.

It can be configured as normally open or normally closed (**Regulations table parameter 6**).

The low oil pressure alarm is configured (**Alarms table parameter 4**) to be detected: **From the started engine condition**

A stabilization time can be associated to the low oil pressure alarm (**Alarms table parameter 5**) to delay the moment in which the alarm conditions are verified

This alarm is configured (**Alarms table parameter 6**) to carry out the following action: **Immediate engine stop.**



Emergency stop. Not programmable in action

The emergency stop alarm of the CEM7 is associated to the specific emergency stop digital input (EMS)

It can be configured as normally open or normally closed (**Regulations table parameter 11**).

In the same way, the emergency stop alarm is also associated to the SETA input from the measurement module. This input cuts the feeding to the power outputs of the measurement module (starting, pre-heating and engine stopping) to make sure the stop of the engines configured as stop by de-excitation (**Regulations table parameter 18**) without considering the electronics of the device. In engines programmed with stop by no-excitation, such input must be connected to earth.

The emergency stop alarm always stops the engine without cooling. No delay timing can be associated to that action, as it is immediately executed after the emergency stop input is detected (EMS).



Battery charge alternator failure

The battery charge alternator failure alarm of the CEM7 is associated to the battery charge alternator voltage analog input (DI). The voltage value of such input must exceed the voltage threshold of the started engine detection (**Thresholds table parameter 21**); if not, the battery charge alternator failure alarm is triggered.

The battery charge alternator alarm is configured (**Alarms table parameter 10**) to be detected:

From the started engine condition

A stabilization time can be associated to the battery charge alternator low alarm (Alarms table 11). During this time the obtained voltage values must be kept under the started engine detection threshold (through the DI input) as a condition for the battery charge alternator failure alarm to be triggered.

This alarm has been initially configured (**Alarms table parameter 12**) to be inactive. (warning)



Starting failure

The starting failure alarm of the CEM7 is triggered if all the starting attempts (**Times table parameter 1**), consecutive and non effective, during the engine starting cycle are effected. Between each start attempt there is a programmable waiting time (**Times table parameter 2**). Once the alarm is produced, the user must check it before trying again with the engine starting process.



Low coolant level

The low coolant level alarm of the CEM7 is associated to the specific low coolant level digital input (NA). The status of this input must be validated during a stabilization time (Times parameter 18) before triggering the low coolant level alarm

It can be configured as normally open or normally closed (**Regulations table parameter 8**).

The low coolant level alarm is configured (**Alarms table parameter 16**) to be detected:

- Always

A stabilization time (**Alarms table parameter 17**) can be associated to the low coolant level alarm to delay the moment in which the alarm condition is verified.

This alarm is configured (**Alarms table parameter 18**) to carry out the following action:

Immediate engine stop if the engine is not already stopped.



Fuel reserve.

The fuel reserve alarm of the CEM7 is associated to the specific fuel reserve digital input (FR) The status of this input must be validated during a stabilization time (**Times table parameter 15**) before triggering the fuel reserve alarm.

It can be configured as normally open or normally closed (**Regulations table parameter 5**).

The low coolant level alarm is configured (**Alarms table parameter 19**) to be detected:

- Always

A stabilization time (**Alarms table parameter 20**) can be associated to the fuel reserve alarm to delay the moment in which the alarm condition is verified.

This alarm is configured (**Alarms table parameter 21**) to carry out the following action:

No actions to be performed (warning)



Overspeed

The overspeed alarm of the CEM7 is associated to the rotation speed of the engine ring gear. This measurement is done through the pick up input of the measurement module. The alarm functions depend that the parameter that determines the number of teeth of the engine ring gear (**Thresholds table parameter 24**) would not be zero.

The overspeed alarm is configured (**Alarms table parameter 22**) to be detected:

- From the engine nominal condition

A stabilization time can be associated to the overspeed alarm (**Alarms table parameter 23**). During this time the rotation speed of the ring gear during this time must be over the maximum limits of the rotation speed (**Thresholds table parameter 11**).

This alarm is configured (**Alarms table parameter 24**) to carry out the following action:

- Immediate engine stop



Underspeed

The underspeed alarm of the CEM7 is associated to the rotation speed of the engine ring gear. This measurement is done through the pick up input of the measurement module. The alarm functions depend that the parameter that determines the number of teeth of the engine ring gear (**Thresholds table parameter 24**) would not be zero.

The underspeed alarm is configured (**Alarms table parameter 25**) to be detected:

- From the engine nominal condition

A stabilization time can be associated to the underspeed alarm (**Alarms table parameter 26**). During this time it must be kept under the programmed minimum limits (**Thresholds table parameter 12**).

This alarm is configured (**Alarms table parameter 27**) to carry out the following action:

- Stop with engine cooling



Overload

The overload alarm of the CEM7 is associated to the effective amperage value in any of the phases. The value must be superior to the maximum programmed overload limit (**Thresholds table parameter 7**) but under the maximum limit of short-circuit (**Thresholds table parameter 8**).

The phases that are checked to detect the overload alarm are selected depending on the configuration of the installation phases (**Thresholds table parameter 1**):

- Single-phase configuration, phase 1 is tested
- Two-phase configuration, phase 1 and 2 are tested.
- Three-phase configuration with neutral or three-phase without neutral, phase 1, 2 and 3 are tested.

The overload alarm is configured (**Alarms table parameter 28**) to be detected:

- From the engine nominal condition

A stabilization time can be associated to the overload alarm (**Alarms table parameter 29**). During this time the amperage values must be kept over the maximum programmed limits (**Thresholds table parameter 7**).

This alarm is configured (**Alarms table parameter 30**) to carry out the following action:

- Stop with engine cooling



Genset voltage asymmetry

The genset voltage asymmetry alarm of CEM7 controls that the difference found between any pair of real voltage values among generating set voltage phases (VG12, VG23 or VG31), must be over the maximum asymmetry programmed limits (**Thresholds table parameter 4**).

The voltage asymmetry alarm is activated only when the device is configured for the measurement of three-phase with neutral or three-phase without neutral voltage values.

The voltage asymmetry alarm is configured (**Alarms table parameter 31**) to be detected:

- From the engine nominal condition

A stabilization time can be associated to the voltage asymmetry alarm (**Alarms table parameter 32**). During this time, the difference between any pair of voltage values of the genset phases (VG12, VG23 or VG31) must be over the maximum asymmetry programmed limits (**Thresholds table parameter 4**).

This alarm is configured (**Alarms table parameter 33**) to carry out the following action:

- Stop with engine cooling



V_G

Maximum genset voltage

The maximum genset voltage alarm of the CEM7 is associated to the fact that the real voltage value obtained from any pair of phases of the genset ((VG12, VG23 or VG31) is over the maximum programmed voltage limits (**Thresholds table parameter 2**).

The phases that are checked to detect the maximum genset voltage alarm are selected

depending on the configuration of the phases in the installation (**Thresholds table parameter 1**):

- Single-phase configuration, V1N voltage is tested
- Bi-phase configuration, V12 voltage is tested
- Three-phase configuration with neutral or three-phase without neutral, V12, V23, V13 voltages is tested.

The maximum genset voltage alarm is configured (**Alarms table parameter 34**) to be

detected:

- From the engine nominal condition

A stabilization time can be associated to the maximum genset voltage alarm (**Alarms table parameter 35**). During this time, the voltage values obtained between genset phases (VG12, VG23 or VG31) must be over the maximum programmed limits. (**Thresholds table parameter 2**).

This alarm can be configured (**Alarms table parameter 36**) to carry out the following action:

- Immediate engine stop.

Hz_G

Maximum genset frequency

The maximum genset frequency alarm of the CEM7 is associated to the fact that the frequency generated by the genset surpasses the maximum programmed frequency limits. (**Thresholds table parameter 5**).

The first-phase is used to measure the genset frequency. If no signal is detected, the measure is taken in the second-phase. In the same way, if no signal is detected, the measure is taken in the third-phase.

The maximum genset frequency alarm is configured (**Alarms table parameter 37**) to

be detected:

- From the engine nominal condition

A stabilization time can be associated to the maximum genset frequency alarm (**Alarms table parameter 38**). During this time, the genset frequency values obtained must be kept over the maximum programmed limits. (**Thresholds table parameter 5**).

This alarm is configured (**Alarms table parameter 39**) to carry out the following action:

- Immediate engine stop

U_G

Erroneous phase sequence of the genset

The erroneous phase sequence of the genset alarm of the CEM7 is associated to the fact that the maximum values of the genset signal phases are in order (phase 1, phase 2 and phase 3 in this order)

The erroneous phase sequence alarm is activated only when the device is configured to work with three-phase with neutral or three-phase without neutral.

The erroneous phase sequence alarm is configured (**Alarms table parameter 40**) to be detected:

From the engine nominal condition

A stabilization time can be associated to the erroneous phase sequence alarm (**Alarms table parameter 41**). During this time an erroneous order in the maximum voltage values of the genset must be detected.

This alarm is configured (**Alarms table parameter 42**) to carry out the following action:

- Stop with engine cooling

P_G

Inverse power

The inverse power alarm of the CEM7 is activated when the power obtained (mains or genset) is negative, and exceeds the resultant value after calculating the programmed factor in a hundred per cent (**Thresholds table parameter 10**) of the nominal power. (**Thresholds table parameter 9**).

Some times, the inverse power alarms can be triggered due to an erroneous wiring of the current transformers.

The inverse power alarm is configured (**Alarms table parameter 43**) to be detected:

- From the engine nominal condition

A stabilization time can be associated to the inverse power alarm (**Alarms table parameter 44**). During this time the power could be out the programmed limits.

This alarm is configured (**Alarms table parameter 45**) to carry out the following action:

- Stop with engine cooling.



Low battery voltage

The low battery voltage alarm of the CEM7 is triggered when the voltage obtained is lower than the programmed limits (**Thresholds table parameter 17**).

The low battery voltage alarm is configured (**Alarms table parameter 46**) to be detected:

- Always

A stabilization time can be associated to the low battery voltage alarm (**Alarms table parameter 47**). During this time, the voltage value detected must be under the programmed limits. (**Thresholds table parameter 17**).

This alarm has been initially configured (**Alarms table parameter 48**) to be inactive. (warning)



High coolant temperature by sensor

The high coolant temperature by sensor alarm is associated to the coolant temperature analog input (T). The high coolant temperature by sensor alarm triggers when a temperature reading is above the programmed limits. (**Thresholds table parameter 27**).

The high coolant temperature by sensor alarm is configured (**Alarms table parameter 49**) to be detected:

- Always

A stabilization time can be associated to the high coolant temperature by sensor alarm (**Alarms table parameter 50**). During this time, the coolant temperature value detected must be over the programmed limits. (**Thresholds table parameter 27**).

This alarm has been initially configured (**Alarms table parameter 51**) to be inactive. (warning)



Low oil pressure by sensor

The low oil pressure by sensor alarm of the CEM7 is associated to the oil pressure analog input (T). The low oil pressure by sensor alarm triggers when the pressure readings are under the programmed limits (**Thresholds table parameter 26**).

The low oil pressure by sensor alarm is configured (**Alarms table parameter 52**) to be detected:

- From the started engine condition

A stabilization time can be associated to the low oil pressure by sensor alarm (**Alarms table parameter 53**). During this time the pressure values must be detected under the programmed limits. (**Thresholds table parameter 26**).

This alarm has been initially configured (**Alarms table parameter 54**) to be inactive. (warning)



Low fuel level by sensor

The low fuel level by sensor alarm of the CEM7 is associated to the fuel level analog input (NC = FL). The low fuel level by sensor alarm triggers when the fuel level is under the programmed limits. (**Thresholds table parameter 25**).

The low fuel level by sensor alarm is configured (**Alarms table parameter 55**) to be detected:

- Always

A stabilization time can be associated to the low fuel level by sensor alarm (**Alarms table parameter 56**). During this time the fuel level values must be detected under the programmed limits (**Thresholds table parameter 25**).

This alarm has been initially configured (**Alarms table parameter 57**) to be inactive. (warning)



High battery voltage

The CEM7 high battery voltage alarm is activated when measured battery voltage exceeds a set limit (**Thresholds table parameter 36**).

The default detection of high battery voltage alarm is configured (**Alarm table parameter 120**) to be detected: Never.

A stabilization time can be associated to the high battery voltage alarm (**Alarm table parameter 121**). During this time the value of battery voltage must be detected higher than the programmed limits (**Thresholds table parameter 36**).

This alarm has been initially configured (**Alarms table parameter 122**) to be inactive (warning).



Low battery voltage at the starting

The CEM7 low battery voltage alarm is activated when the battery voltage measured is below a set limit (**Thresholds table parameter 37**).

The detection of low battery voltage alarm is configured by default and cannot be changed (**Alarm table parameter 123**) to be detected: At starting

A stabilization time can be associated to the low battery voltage alarm (**Alarm table parameter 124**). During this time the value of battery voltage must be detected below the programmed limits (**Thresholds table parameter 37**).

This alarm has been initially configured (**Alarms table parameter 125**) to be inactive (warning).



Short circuit

The short circuit alarm of the CEM7 is associated to real amperage value when any of the phases are over the maximum short circuit programmed limits (**Thresholds table parameter 8**).

The phases that are checked to detect short circuit alarm are selected depending on the configuration of the phases in the installation (**Thresholds table parameter 1**):

- Single-phase configuration, phase 1 is tested
- Two-phase configuration, phase 1 and 2 are tested.
- Three-phase configuration with neutral or three-phase without neutral, phase 1, 2 and 3 are tested.

The short circuit alarm is configured (**Alarms table parameter 58**) to be detected:

- From the engine nominal condition

This alarm is configured (**Alarms table parameter 60**) to carry out the following action:

- Stop with engine cooling

V_G

Minimum genset voltage

The minimum genset voltage alarm of the CEM7 is associated to the fact that real voltage value obtained from any pair of phases of the genset (VG12, VG23 or VG31) is under the minimum programmed voltage limits (**Thresholds table parameter 3**).

The phases that are checked to detect the minimum genset voltage alarm are selected depending on the configuration of the phases in the installation (**Thresholds table parameter 1**):

- Single-phase configuration, V1N voltage is tested
- Bi-phase configuration, V12 voltage is tested
- Three-phase configuration with neutral or three-phase without neutral, V12, V23, V13 voltages are tested.

The minimum genset voltage alarm is configured (**Alarms table parameter 61**) to be detected:

- From the engine nominal condition

A stabilization time can be associated to the minimum genset voltage alarm (**Alarms table parameter 62**) During this time, the voltage values obtained between genset phases (VG12, VG23 or VG31) must be under the minimum programmed limits. (**Thresholds table parameter 3**).

This alarm is configured (**Alarms table parameter 63**) to carry out the following action:

- Stop with engine cooling

Hz_G

Minimum genset frequency

The minimum genset frequency alarm of the CEM7 is associated to the fact that the frequency generated by the genset is under the minimum programmed frequency limits. (**Thresholds table parameter 6**).

The first-phase is used to measure the genset frequency. If no signal is detected, the measure is taken in the second-phase. In the same way, if no signal is detected, the measure is taken in the third-phase.

The minimum genset frequency alarm is configured (**Alarms table parameter 64**) to be detected:

- From the engine nominal condition

A stabilization time can be associated to the minimum genset frequency alarm (**Alarms table parameter 65**). During this time, the genset frequency values obtained must be kept under the minimum programmed limits (**Thresholds table parameter 6**).

This alarm is configured (**Alarms table parameter 66**) to carry out the following action:

- Stop with engine cooling



Unexpected shutdown

The unexpected shutdown of the CEM7 triggers when the controller, while the engine is running, does not detect all the engine starting conditions. (**Regulations table parameters 19 to 22**).



Stop failure

The stop failure alarm of the CEM7 is raised if 15 seconds after the engine stop attempt it is not detected all conditions of the engine (**Regulations table parameters 19 to 22**).

In case the stop failure alarm is disconnected (**Alarms table parameter 70**), the device will consider the engine as stopped after waiting the stop conditions for a maximum time of 15 seconds.

To detect the stop of the engine, all the stopping conditions must be detected during a programmed time (**Alarms table parameter 71**).



Low engine temperature

The low engine temperature alarm of the CEM7 is associated to the analog coolant temperature input (T). The low engine temperature alarm triggers when a temperature value is under the programmed limits. (**Thresholds table parameter 28**).

The low engine temperature alarm is configured (**Alarms table parameter 73**) to be detected:

- Never

A stabilization time can be associated to the low engine temperature alarm (**Alarms table parameter 74**). During this time, the coolant temperature values must be detected under the programmed limits (**Thresholds table parameter 28**).

The low engine temperature alarm, once activated, can set up the controller to do not switch on the Genset change over until the engine exceeds the low temperature limits (**Thresholds table parameter 28**).



Genset signal failure

The genset signal failure alarm of the CEM7 is triggered if, while the engine is running, no voltage is detected in any of the phases.

The genset signal failure alarm is configured (**Alarms table parameter 76**) to be detected:

- From the engine nominal condition

A stabilization time can be associated to the genset signal failure alarm (**Alarms table parameter 77**). During this time it must not be detected any phase signal before rising the alarm.

This alarm is configured (**Alarms table parameter 78**) to carry out the following action:

- Stop with engine cooling



Programmable alarm 1

The programmable alarm 1 of the CEM7 is activated by associating one of the general digital inputs (ENT1, ENT2, ENT3, ENT4 or ENT5) to the working mode of the programmable alarms. (**Programming table parameter 13**). The status of such input must be validated during a stabilization time (**Times table parameter 19, 20, 22, 23 or 24**) before triggering the programmable alarm 1 alarm.

The programmable alarm 1 is configured (**Alarms table parameter 79**) to be detected:

- Never

A delay time (**Alarms table parameter 80**) can be associated to the programmable alarm 1 in order to restrain the moment in which the alarm conditions are checked.

This alarm has been initially configured (**Alarms table parameter 81**) to be inactive. (warning)

A programmable text can be associated to the programmable alarm 1 and will appear on the visualization module display when the alarm is triggered



Programmable alarm 2

The programmable alarm 2 of the CEM7 is activated by associating one of the general digital inputs (ENT1, ENT2, ENT3, ENT4 or ENT5) to the working mode of the programmable alarms. (**Programming table parameter 14**). The status of such input must be validated during a stabilization time (**Times table parameter 19, 20, 22, 23 or 24**) before triggering the programmable alarm 2 alarm.

The programmable alarm 2 is configured (**Alarms table parameter 82**) to be detected:

- Never

A delay time (**Alarms table parameter 83**) can be associated to the programmable alarm 2 in order to restrain the moment in which the alarm conditions are checked.

This alarm has been initially configured (**Alarms table parameter 84**) to be inactive. (warning)

A programmable text can be associated to the programmable alarm 2 and will appear on the visualization module display when the alarm is triggered.



Programmable alarm 3

The programmable alarm 3 of the CEM7 is activated by associating one of the general digital inputs (ENT1, ENT2, ENT3, ENT4 or ENT5) to the working mode of the programmable alarms. (**Programming table parameter 15**). The status of such input must be validated during a stabilization time (**Times table parameter 19, 20, 22, 23 or 24**) before triggering the programmable alarm 3.

The programmable alarm 3 is configured (**Alarms table parameter 85**) to be detected:

- Never

A delay time (**Alarms table parameter 86**) can be associated to the programmable alarm 3 in order to restrain the moment in which the alarm conditions are checked.

This alarm has been initially configured (**Alarms table parameter 87**) to be inactive. (warning)

A programmable text can be associated to the programmable alarm 3 and will appear on the visualization module display when the alarm is triggered.



Programmable alarm 4

Programmable alarm 4 of the CEM7 controller is activated, in the programmable alarm operation mode. (**Programming table, parameter 22**), by associating it with one of the general-purpose digital inputs (ENT1, ENT2, ENT3, ENT4 or ENT5)

The state of this input must be validated during a stabilizing (anti-bounce) period (**Times table parameters 19, 20, 22, 23 or 24**) before generating the programmable alarm 4 alarm.

The detection of the programmable alarm 4 is configured by default (**Alarms table parameter 111**) to run: Never.

A time (**Alarms table parameter 112**) can be associated with programmable alarm 4 to delay the moment in which it begins to verify the alarm conditions.

Programmable alarm 4 is configured by default (**Alarms table parameter 113**) to not take any action (warning).

Programmable text can be associated with programmable alarm 4 that will appear on the display (in the display module) when an active alarm is detected.



Programmable alarm 5

Programmable alarm 5 of the CEM7 controller is activated, in the programmable alarm operation mode (**Programming table parameter 23**) by associating it with one of the general-purpose digital inputs (ENT1, ENT2, ENT3, ENT4 or ENT5).

The state of this input must be validated during a stabilizing (anti-bounce) period (**Times table parameters 19, 20, 22, 23 or 24**) before generating the programmable alarm 5 alarm.

The detection of the programmable alarm 5 is configured by default (**Alarms table parameter 114**) to run: Never.

A time (**Alarms table parameter 115**) can be associated with programmable alarm 5 to delay the moment in which it begins to verify the alarm conditions.

Programmable alarm 5 is configured by default (**Alarms table parameter 116**) to not take any action (warning).

Programmable text can be associated with programmable alarm 5 that will appear on the display (in the display module) when an active alarm is detected.



7. MAINTENANCE

7.1. Working Counters

THE CEM7 DEVICE RECORDS A NUMBER OF STORED VALUES REGARDING THE CONTROL BOARD FUNCTIONS. THE COUNTERS OF THE DEVICE ARE:

- **Total working hours counter.** The device records the number of working hours of the genset engine. This counter can not be reset.
- **Partial working hours counter.** The device records the number of working hours of the genset engine. This counter can be reset and it starts from 0.
- **Succeeded starts counter.** The device records the number of obtained starts. This counter can be reset and it starts from 0.
- **Failed starts counter.** The device records the number of failed starts. This counter can be reset and it starts from 0.
- **Total counter of power.** The device records the total amount of power produced by the genset (MWh). This counter can not be reset.
- **Partial counter of power.** The device records the total amount of power produced by the genset (MWh). This counter can be reset and it starts from 0.
- **Daily counter of power** (option programming timer needed). The daily counter of power registers the quantity of power produced by the genset from the 00:00H. of the present day up to the moment of checking. With the change of the day, the stored power values along the day are added to the monthly energy values. The daily counter then starts from 0.
- **Monthly counter of power** (option programming timer needed). The monthly counter of power registers the quantity of power produced by the genset from the first day of the current month up to the day before the moment of checking. With the change of month, the stored power values are added to the annual power counter. The monthly counter then starts from 0.
- **Annual counter of power** (option programming timer needed). The annual counter of power registers the quantity of power produced by the genset from 1st January up to the month before to the moment of checking. With the change of year, the stored power values are reset and the counter starts from 0.

The user can see the counters readings accessing from the menu **Main→3.Counters**

The partial counters can be reset to "0" by selecting them with UP/DOWN arrow keys and then holding the **RESET** button for 5 seconds.



7.2. Maintenance counters

7.2.a. Enlargement of the maintenance and rental counters

CEM7: 3.00 version and above

PHG6: 2.04 version and above

The enlargement of the maintenance and rental counters replaces the previous version simple counter.

The CEM7 controller has 3 programmable meters that charges whit a certain time and start decreasing when detects engine start. These meters are:

- **2 engines maintenance meters.** When meters goes to 0 create a alarm without shutdown engine. The alarm disappears when the meter is setup again.

- **1 rental meter.** The meter creates an alarm that can shutdown the engine. The alarm disappear when rental meter in setup again.

Maintenance Meters allows:

Programming. Maintenance meter is setup from Meter Menu → Mant.#1, Mant.#2 and Rental. Pushing button ✓ you have access to the timing set up value that should be different to 0. In case of rental alarm after programming the running hour limit, the alarm setup value allows the following options:

- 0: Alarm.
- 1: Shutdown without cool down period.
- 2: Shutdown with cool down period.

Display. The remaining time before that the maintenance alarm switch on is display on the Meters Menu → Mant.#1 in hours and minutes

Programming. The maintenance meter is program from Meters Menu → Mant.#1. Pushing button ✓ you have access to the time value setup that should be different of 0 hours.

Cancellation. To cancel the on going maintenance meter you should program on the Meter Menu → Mant.#1 pushing button ✓ and writing value equal to 0.

7.3. Fault history

The CEM7 device registers the alarms and saves the status of the control board in the moment of the detection.

The CEM7 stores the last 10 detected failures. With the programming timer, 100 additional failures can be added to the fault history, including the date and hour of the moment in which the failure was produced.



7.4. Equipment list

7.4.a. Information about equipment list

CEM7 allows identification and display of all the electronic devices connected to the controller. In order to view these parameters we have to go to Parameters Menu -> equipment list. This option menu shows all the electronic devices (PHR and PHG) and display (CEM, CEA and CEC) currently connected, marc with and (*) the module from which is displaying the equipment list.

As information of these equipment is specify:

As information of these equipments is specified the following:

- The electronic module model
- The electronic module identifier (from 0 to 14)
- The firmware version
 - For the display modules (CEM, CEA and CEC), is indicated between bracket the measures group associated with. For display modules (CEM and CEA), the display module Master has to has the same identifier than the measured group associated. For repetitive display module, the module has to have different identifier than the Master display and has to be associated to the same measure module. The display of the visualization modules of the ATS panels (CEC) must have the same identification as the measurements module in the ATS linked and the measurements module identification linked to the manual control panel.

NOTE: Is not allowed the existence of analogous modules (PHG and PHR; CEM and CEA; CEC) with the same identifier. If the visualization module detects another similar module with the same identifier, displayed the message ID. FAILURE DISPLAY.

When the module identifier is change, it is automatically reseted. Never change the identifier of measure group with the genset working.

7.4.b. Identifier assign operating process.

As Standard all the electronic modules have identifier 0, for the start up of installations with several controller connected between them, has to assign the identifiers of the different modules. To do that, has to start the different controllers, assigning to each one of them different identifier according to the start sequence.

7.5. Reset intensity measurement

For a failure in the reading of intensity values with the genset without load, can be reset to zero (Measurement parameters table 6, 8 and 10, any of these 3 reset to 0 the 3-intensity channel).

The display does not allow changing the mode of the Master controller.

7.6. Analogue Sensors Slope Programming

The CEM7 controller has a series of temperature and pressure sensor curves programmed for distinct types of VDO capsules (Model 323-803-001-008 for temperature and model 360-081-030-009 for pressure) and engines (VOLVO, JCB, SCANIA, YANMAR).

Through parameter 29 of the regulations table, you can choose the type of sensor installed in the genset.

In addition to the programmed curves, there are 2 sensor curves (one for pressure and another for temperature) of up to 8 points each, configurable by the user.

To program these curves from the option Menu→Parameters→Sensors, follow these instructions:

1. There is a maximum of up to 8 points for each programmable curve.
2. With ohms values for the resistance value of the sensor curve. The resistance values of the response curve of the sensor should be entered in descending order; meaning, the first point should correspond to the highest resistance value, the second point to the second highest resistance value, and so fort. Only positive resistance values are permitted in the programming of points for the sensor curve.
3. The temperature values of the points for the sensor curve should be entered in centigrade. Positive and negative temperature values are allowed in the points programming of the sensor curve.
4. The pressure values of the points for the sensor curve should be entered in kilopascals. Only positive pressure values are allowed in the programming of points of the sensor curve.
5. The temperature curve can be applied to the temperature sensor of the cooler as well as to the auxiliary sensor (by default, oil temperature).
6. The pressure curve is applied to the oil pressure sensor.



8. EXPANSIONS

NEW FUNCTIONAL OPTIONS CAN BE ADDED TO THE CEM7 DEVICE WITH THE CAN BUS CONNECTION ALLOWING NEW EXPANSION MODULES.

8.1. Repetitive Visualization Display

CEA7 and CEM7 controllers allow to add visualization modules to the device. This device shows the current status of the control panel. When the control panel is set in automatic mode, it allows to make a remote start of the genset. The display does not allow changing the mode of the Master controller.

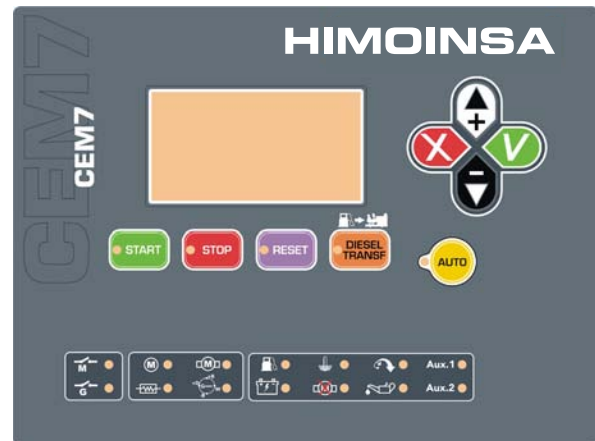

More over, this visualization display allows to check the control panel status by means of "error and status LED's" and also the programming of the parameters of working.



8.2. Programming timer

The CEM7 allows the connection of a programming timer device to the visualization module. The timer informs the control board about the current date and hour.

The installation of a programming timer device to the CEM7 allows the weekly programming of:

- Programmed starts.
- Programmed cut-outs.
- Programmed engine tests.
- Expansion of the fault history
- Power counters (day, month, year).

The maximum capacity of the timer is 5 daily programs. The CEM7 must be in automatic mode to carry out the programming.

8.2.a. Installation in visualization module.

Programming timer will be located at the back of the visualization module of the CEM7 control panel in a simple and accurate way.

1. Trim the mechanized line at the back of the control panel (right lower side).

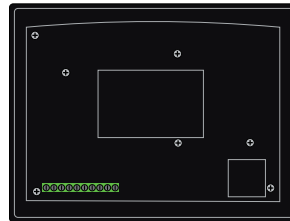

2. Once when have open the place, put the programming timer in the connexion position (see pins) and press for a proper installation.

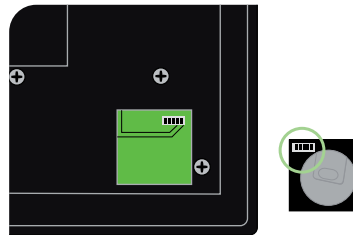

3. It will be slightly raised so that it is easy to access.

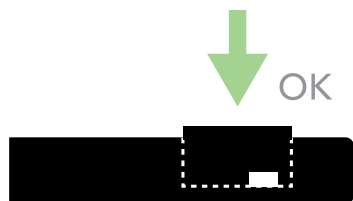



8.3. Telesignal

CEM7/CEA7 ALLOWS THE SUPERVISION OF THE CONTROLLER STATUS THROUGH A SERIES OF RELAY OUTPUTS.

Telesignal option is connected to Himoinsa CEM7/CEA7 controllers by means of a CAN Communication cable. Through the control panel configuration software, we can adjust it.

Telesignal is connected to the controller by means of a twisted pair which can be shielded or not (1 mm²) depending on the environment of installation and up to 1Km long. CEM7/CEA7 allows the installation up to 4 telesignal options simultaneously.

Telesignal device has the following components:

- Power supply and communications
- 12 Terminal block for digital outputs to relays: (4 outputs of NC/NO contact and 8 outputs of NO contact)
- 1 power supply LED
- 12 LEDs displaying the output status.
- Microswitch for activation of CAN terminator.
- Microswitch with 2 switches to fix the number of modules (maximum 4).

8.3.a. Functions:

The outputs of the Telesignal expansion can be programmed to activate, depending on:

- Any active alarm or one pending notification from the control panel.
- Any active input from the control panel.
- Any active output from the control panel.
- Status of the mains (CKR) or genset (CKG) contactors.
- Functioning mode of the mains (manual, automatic, blocking and test)
- Quality of the mains and mains signal.

Each output from the Telesignal device is activated when there is at least one of the conditions of activation programmed.

NOTA: For configurations which are different to the CE7 tele-signal factory Standard we need to use the corresponding CAN/USB converter and the PC software. (Further information in the Tele-signal manual).

NOTA: Module is mounted in bar C-DIN in 50035 or OMEGA-DIN in 50022-50045.



8.4. J1939

The CEM7 allows the connection of a J1939 device. This device can control a number of parameters of the engine working mode, depending on the manufacturer and the engine model (ask your distributor):

- Pressure values, temperature.
- Engine alarms.
- Engine error codes.
- Starting and stop process.
- Fine adjustment of speed regulated by parameter or analogical entry of 0-10V (synchronization).

The engines status is displayed via J1939 in the ENGINE REDINGS screen, when J1939 expansion is detected.

There are 2 new screen shots in option 9 of the menu display:

- Engine error visualization screen: history of active and passive errors detected by the engine

regulation. The first screen shows a list of errors detected. By pressing ACCEPT each error is

shown:

- Error code
- Engine working hours when error occurred
- If it is an active or passive error
- Blinking code associated to it

Level 3 password allows deleting error history stored in the electronic engine regulation.

- J1939 in autonomous mode allows a start screen display. Extension J1939 allows an autonomous mode for engine start and stop independently from the control panel. These starts are registered in extension J1939 with the engine working hours of the electronic regulation.

8.5. Remote visualization screen or repetitive display: (remote visualization option)

THE REPETITIVE DISPLAY SCREEN OPTION ALLOWS THE SUPERVISION AND CONTROL OF A GENERATING SET REMOTELY.

The generating set could have a second viewer on the distance. This option is connected to the Himoinsa control panel through a wire with an intertwined pair with or without screen depending on the installation surroundings and up to 1 km long. Allows the installation of 14 options of repetitive display simultaneously.

The remote display will be always CEM7 model (only visualization display) and is available in all models of generating set with controllers CEM7 and CEA7.

8.5.a. Functions:

- Display of the control panel general status.
- Programming of the control panel operation parameters.
- Control of the panel: start and stop in automatic mode. (It does not allow to change the control panel working mode).



8.6. Change over power source

It is a power supply source of low-cost power supply equipped with an AC voltage input from 200VAC to 300VAC and non regulated voltage output.

It is installed in the changeover panel in order to supply both modules from the switchboard controllers, PHR6 and CEC7 (PHR6 and CEA7 as options). The power source has an auxiliary battery to keep the power supply on both modules during a mains failure episode and until the moment the genset starts.

8.6.a. Characteristics

- AC voltage input from 200VAC to 300VAC.
- Input protection fuse 5x20mm
- Rectified and filtered output voltage.
- Rechargeable battery NiMH 8,4V 170mAh.
- Battery charger "trickle charger" type.
- Mounted on plastic profile for the installation on DIN rail.

8.7. Second Zero Suppression (CEM7 + CEC7)

The Second Zero Suppression expansion is an electronic module whose function is to avoid the second zero that is produced in the switching when the power returns and the generator group disconnects.

This module will communicate by CAN with the switching measures module which will give it information on the network and group synchronization. It will have two analogical outputs to control the motor speed (SPEED signal) and the regulation of the alternator tension (AVR signal).

The module will incorporate an additional function of a series of digital and analogical inputs and digital outputs that will be used as an expansion of inputs/outputs of the PHG module.

8.7.a. Functions:

There are 3 functions implemented by the expansion of Second Zero Suppression:

- Suppression of the second zero when the power returns, load start-up on demand with synchronization with the network and start-up by external order with synchronization with the network. Said functions use 2 analogical outputs to regulate:
 - AVR: The amplitude of the group tension regulated by the alternator.
 - SPEED: The group tension frequency regulated by the motor.

The analogical outputs regulate the characteristics of the group tension until it reaches a synchronization in amplitude, phase and frequency with that of the network signal. Said synchronization is used to switch the connectors, passing the network tension on to supply the installation.



- Expansion of inputs/outputs. Said function uses the digital inputs and outputs of the Second Zero Suppression module to provide the CE6 exchange with additional inputs and outputs. The digital inputs and outputs can be programmed with the same operation options as the digital inputs and outputs of the PHG6 module. Starting from the firmware version of the PHG6v.251 module, said expansion is used to create 2 additional programmable alarms and an auxiliary battery alarm. Of the 4 additional digital outputs that come with the Second Zero Suppression module, only 2 have direct output to the terminal. To use the remaining 2, you must request a special order of the module.
- Reading of auxiliary battery tension. Said functions use the analogical input 1 of the Second Zero Suppression module to read the auxiliary battery tension. Said reading is shown on the motor screen of the CEM/CEA visualization module of the generator group.



9. (ANNEX I) COMMUNICATION MODULES

9.1. Local mode telecontrol

CAN/USB: LOCAL TELECONTROL GUARANTEED FOR A DISTANCE OF LESS THAN 1KM.

With this type of connection the cost of communication is null.

The option CAN/USB is focused on the monitoring, control and configuration of a generating set connected to a PC by CAN/BUS.

CAN/RS485: LOCAL TELECONTROL VIA MODBUS PROTOCOL

The CAN/RS485 through MODBUS protocol, can extract and incorporate certain values and details of the generating set into an own control system. This allows the control and monitoring.

CAN/LAN: LOCAL TELECONTROL ETHERNET NETWORK (INTRANET).

CC/LAN allows a genset monitorization, control and configuration by connection between the controller and the telecontrol and configuration software, in an Ethernet network (intranet). Through PC is achieved the control of a generating set located in a building, factory, etc, connected to an internal local network.



9.1.a. CAN/USB: Telecontrol for a distance less than 1 km.

The option CAN/USB is focused on the monitoring, control and configuration of a generating set connected to a PC by CAN/BUS.

This mode of local telecontrol is guaranteed for a distance of less than 1km. With this type of connection the cost of communication is null.

The converter CAN/USB allows:

- The connection through USB of the device to a PC.
- Management of the controller configuration.
- Total monitoring and control using Software.

To configure the telecontrol in Local mode we need the following components:

• Kit CAN/USB Converter that includes:

- CAN/USB Converter.
- USB cable to connect to the computer.
- Db9 connector.
- Telecontrol Software CE for PC.
- Configuration Software CE for PC.

PC that meets the following requirements in order to run the monitoring and configuration software:

Pentium III 1.3 GHz Processor, Microsoft Windows XP with Microsoft.Net Framework 2.0, 512 Mb RAM, 50 Mb free hard disk space

Functions:

- Possibility of total management from PC.
- Input/Output status visualization.
- Memory Events visualization date/ hour (history records).
- Alarms visualization.
- Controller function mode management.
- Parameters management.



9.1.b. CCRS485: Telecontrol via MODBUS protocol.

CE7 controller's family allows the supervision and remote control through the CCRS MODBUS option.

This option CCRS MODBUS allows to achieve a connection between the controller and any other device that implement such protocol.

The CCRS485 kit through MODBUS protocol can extract and incorporate certain values and details of the generating set to the own control system.

The CAN RS485 Converter allows:

- The connection of the control device to another device (via MODBUS).
- The supervision and control.
- And extracting information of certain values and details of the generating set for control and monitoring that can be incorporated into an own control system.

The CAN/RS needs the following elements for its installation:

• Kit CAN RS 485 that includes:

- CCRS485 converter
- Connectors
- Documentation refereed to protocol
- Connection to the controller through CAN BUS communication.
- Power supply.
- Connection to the control, management and communication device that implement the MODBUS protocol in its master configuration.

Functions:

- Genset control and visualization in the control system.
- Management of the controller configuration.
- Genset alarms management.
- Controller function mode management.

9.1.c. CAN/LAN: Local telecontrol Ethernet network (Intranet).

The CE7 family of controller allows remote supervision and control using the CCLAN option. The CCLAN option allows a connection to be made between the control panel and the monitoring and configuration software through an Ethernet connection (Intranet). Through PC is achieved the control of a generating set located in a building, factory, etc. This is connected to an internal local network.

Through the Software CCLAN configuration is assigned to the converter's IP address and communication port. Once installed the telecontrol and configuration software on any PC of the intranet, we can connect to the controller through its IP.

The converter CAN / LAN allows:

- Full control via PC.
- Management of the configuration of the control device.
- Monitoring, control and configuration using Software.

To configure the telecontrol, we need the following elements:

- CAN/LAN converter,
- CC/LAN configuration software.
- CE telecontrol software for PC.
- CE configuration software for PC.
- PC that meets the following requirements to run the monitoring and configuration software: Pentium III 1.3 GHz Processor, Microsoft Windows XP with Microsoft. Net Framework 2.0, 512 Mb RAM, 50 Mb free hard disk space, 10/100 Mbps network card
- Ethernet connection.

Functions:

- Total management through PC.
- Control panel visualization.
- Memory Events visualization date/ hour (history records).
- Alarms visualization.
- Parameters management
- Start and Stop.
- Controller function mode management.



9.2. Remote mode telecontrol

CAN/RS232: TELECONTROL BY MODEM

CCRS232 option allows the supervision and the remote control. By means of a connection through a line modem or GPRS/GSM modem between the genset control panel and the Telecontrol and Configuration software.

CAN/LAN: REMOTE MODE TELECONTROL BY ETHERNET (INTERNET)

CCLAN allows a connection to be made between the control panel and the monitoring and configuration software through an Ethernet connection (Internet). Through this type of connection, the cost of the communication would be the same flat fare contracted for the Internet access.

For this application, we need the configuration of a router with the IP and the port (re-directed) to CC/LAN.

CAN/LAN MODBUS: COMMUNICATIONS OPTIONS FOR MODBUS IP PROTOCOL

The family of exchanges CEA, CEM and CEC allows remote supervision and control through the CCLAN MODBus option. The CCLAN MODBus option allows a connection between the exchange and any other device that implements said protocol.

9.2.a. CAN/RS232: Telecontrol Communications by MODEM

CCRS232 option allows the supervision and the remote control. By means of a connection through a line modem or GPRS/GSM modem between the genset control panel and the Telecontrol and Configuration software.

CAN/RS232 converter allows:

- Control by PC with a conventional telephone line. (option Kit CAN/RS232 Zoom)
- Control by SMS when there is not a conventional line. (option kit CAN/RS232 GSM)
- Total management for the configuration of the control panel.
- Remote control and monitoring.
- Positioning via GPS and alarms when the genset is out of the perimeter preestablished, etc... (option Kit CAN/RS232 + positioning)

To configure the telecontrol in remote mode, we need the following components:

CAN/RS232 converter.

- Analogical MODEM or GPRS/GSM.
- Null modem cable.
- CCRS configuration software.
- CE telecontrol software for PC.
- CE configuration software for PC.
- PC that meets the following requirements to run the monitoring and configuration software: Pentium III 1.3 GHz Processor, Microsoft Windows XP with Microsoft. Net Framework 2.0, 512 Mb RAM, 50 Mb free hard disk space, 10/100 Mbps network card

Functions:

- Phone calls for alarms.
- Total management from PC.
- Control panel visualization.
- Memory Events visualization with date/day/hour (History records).
- Alarm visualization.
- Ability to change the controller working mode.
- Parameters setting.
- Start, stop and reset of the control panel by SMS sends (only with GPRS/GSM option).



9.2.b. CAN/LAN: Telecontrol Remote telecontrol by Ethernet network (Internet)

The CE7 family of controller allows remote supervision and control using the CCLAN option. The CCLAN option allows a connection to be made between the control panel and the monitoring and configuration software through an Ethernet connection (Internet). Through this type of connection, the cost of the communication would be the same flat fare contracted for the Internet access. For this application, we need the configuration of a router with the IP and the port (re-directed) to CC/LAN.

CAN/LAN device allows as follows:

- Control by PC
- Total management for the configuration of the control panel.
- Remote control, configuration and monitoring.

To configure the remote telecontrol, we need the following elements:

- CAN/LAN converter,
- CC/LAN configuration software.
- CE telecontrol software for PC.
- CE configuration software for PC
- PC that meets the following requirements to run the monitoring and configuration software: Pentium III 1.3 GHz Processor, Microsoft Windows XP with Microsoft. Net Framework 2.0, 512 Mb RAM, 50 Mb free hard disk space, 10/100 Mbps network card
- Ethernet connection.

Functions:

- Phone calls for alarms.
- Total management from PC.
- Control panel visualization.
- Memory Events visualization with date/day/hour (History records).
- Alarm visualization.
- Ability to change the controller working mode.
- Parameters setting.
- Start and stop.

9.2.c. CAN/LAN MODBUS: Communications options for MODBUS IP protocol

The family of exchanges CEA, CEM and CEC allows remote supervision and control through the CCLAN MODBUS option. The CCLAN MODBUS option allows a connection between the exchange and any other device that implements said protocol.

The CCLAN MODBUS IP protocol allows:

- The connection through MODBUS of the exchange to another device.
- Supervision and control.
- Extraction of information of specific data and values of the generator group for its control and monitoring that can be incorporated in its control system.
- The CCLAN MODBUS IP option needs the following elements for its installation:
 - Connection to the exchange through the CAN communications bus.
 - Power supply.
 - Connection to a management and control device that implements the MODBUS IP communication protocol in its master configuration.
- Functions:
 - Control and visualization of the generator group control system.
 - Control of the exchange programming.
 - Management of the group alarms.
 - Change of the exchange operating mode.



10. (ANNEX II) PARAMETERS TABLE

THE CEM7 DEVICE ALLOWS 3 LEVELS OF ACCESS TO THE CONFIGURATION.

To modify any parameter of the CEM7, a validation is required, by means of a password introduction. The 3 access levels are:

- 1. User access.** Allows the setting of the **level 1 parameters**. (default password: 1111)
- 2. Maintenance access.** Allows the setting of the **level 1 and 2 parameters**. (default password: 1911)
- 3. Supervisor access.** Allows the setting of the **level 1, 2 and 3 parameters**. (value resting use, only manufacturer)



TIMES				
Parameter	Psw	Description	Default Value	Range
1	2	Number of starts	4	1..10
2	2	Time between starting Time between one starting attempt and another. All the outputs are deactivated	5''	3''..15''
3	2	Starting delay Range of time between mains failure and engine starting	0''	0''..1800''
4	2	Glow plug pre-heating time	0''	0''..180''
5	2	Starting time Maximum waiting time before detecting the starting condition. During this time the starting output is active.	5''	1''..30''
6	2	Activation of load time Range of time from the detection of the engine starting condition to the genset contactor activation.	3''	1''..600''
7	2	Nominal condition time Range of time from the detection of the engine starting condition to the quality validation of the generated signal.	2''	2''..15''
8	2	D+ activation time Being this time over, the voltage values of the DI input will be checked, and the D+ output will be activated, or not, until the stop of the engine (according PR regulations parameter (3))	3''	1''..10''
9	2	EJP1 delay	1''	1''..1800''
11	2	Cooling time	120''	2''..1800''
12	2	Emergency Stop activation time	10''	1''..30''
14	2	Maximum time for alarm activation The alarm output will be activated (together with the flashing of the reset button and the buzzer on the display) when corresponds within this limited time	15''	0-Undefined 1''..1800''
15	2	Filtered from FR input	1.0''	0.0''..5.0''
16	2	Filtered from LOP input	1.0''	0.0''..5.0''
17	2	Filtered from HCT input	1.0''	0.0''..5.0''
18	2	Filtered from CL input	1.0''	0.0''..5.0''
19	2	Filtered from INT4 input	1.0''	0.0''..5.0''
20	2	Filtered from INT5 input	1.0''	0.0''..5.0''
22	2	Filtered from INT1 input	1.0''	0.0''..5.0''
23	2	Filtered from INT2 input	1.0''	0.0''..5.0''
24	2	Filtered from INT3 input	1.0''	0.0''..5.0''
26	2	Detection time for activation/deactivation of dummy load	5''	1''..3000''
27	2	Detection time for activation/deactivation of peak saving	5''	1''..3000''



MEASUREMENTS				
Parameter	Psw	Description	Default Value	Range
1	2	Conversion factor of the amperage transformers Common factor to the real intensity values IR,IS,IT	100	
6	2	Regulation voltage zero. Voltage readings reboot.		
8				
10				
12	2	Fuel level regulation FULL		
13	2	Fuel level regulation EMPTY		

REGULATIONS				
Parameter	Psw	Description	Default Value	Range
1	2	Transfer Fuel Pump working mode	3	0-Off 1-Manual 2-Automatic 3-Central Mode / Combined Mode
2	2	Starting mode by default	1	0-Locked 1-Manual 2-Automatic 3-Test
3	2	D+ deactivation	0	0-Alternator 1-Dynamo
4	2	BT relay output configuration Pre-heater or fuel transfer pump Thermal protection	1	0-Inhibited 1-Transfer pump 2- Heater 3-Thermal protection
5	2	FR input configuration	1	0-OFF 1-Normally open. 2- Normally closed.
6	2	LOP input configuration	1	
7	2	HCT input configuration	1	
8	2	CL input configuration	1	
9	2	INT4 input configuration	1	
10	2	INT5 input configuration	1	
11	2	EMS input configuration	2	
12	2	INT1 input configuration	1	
13	2	INT2 input configuration	1	
14	2	INT3 input configuration	1	
15	2	EMER/CS input configuration	2	



REGULATIONS				
Parameter	Psw	Description	Default Value	Range
16	2	Input associated to the LED AUX1 from the visualization module	0	0-No programmed 1-FR 2-LOP 3-HCT 4-CL
17	2	Input associated to the LED AUX2 from the visualization modul	0	5- INT4 6- INT5 7-EMS 8-INT1 9-INT2 10-INT3
18	2	Pre-heating and programmed stop inputs configuration	0	0-PD/PR 1-PE/PR 2-PD/PE
19	2	Phase voltage with Start condition	1	0-Off 1-Manual 2-Automatic 3-Control board
20	2	Alternator voltage as starting condition	1	
21	2	PICK-UP input as starting condition	1	
22	2	LOP input as starting condition	2	
23	2	Voltage transformer	0	
24	2	Amperage measurement location.	0	0- Output line 1-Genset control panel
25	3	Manual override working mode	1	0-Not allowed 1- Starting due to Mains failure 1- Starting due to manual override.
26	2	Rotation speed of the engine ring gear related with genset voltage frequency	0	0-50Hz/1500rpm 60Hz/1800rpm 1-50Hz/3000rpm
27	2	Temperature readings	0	0-Centigrade 1-Fahrenheit
28	2	Pressure readings	0	0-Bar 1-Psi
29	3	Type of analogical sensors	0	See analogical sensors table
30	2	Type of control board selection	0	0: Manual 1: Automatic

NOTE: After the modification of the parameter 30, you should restart the control board, disconnecting its feeding, to allow the upgrade in its operation mode.



ANALOGICAL SENSORS TABLE Related to parameter 29 of the Regulations table			
Value	Coolant temperature	Oil Pressure	Oil Temperature
0	VDO: 323-803-001-008	VDO: 360-081-030-009	VDO: 323-803-001-008
1	SCANIA	SCANIA	
2	Yanmar	Yanmar	
3	JCB	VDO: 360-081-030-009	
4	VOLVO	VOLVO	
5	Programmable 1	Programmable 2	
6	Programmable 1	VDO: 360-081-030-009	
7	VDO: 323-803-001-008	Programmable 2	Programmable 1: See the Table of Dotted Curve of the Auxiliary sensor
16	VDO: 323-803-001-008	VDO: 360-081-030-009	
17	SCANIA	SCANIA	
18	Yanmar	Yanmar	
19	JCB	VDO: 360-081-030-009	
20	VOLVO	VOLVO	
21	Programmable 1	Programmable 2	
22	Programmable 1	VDO: 360-081-030-009	
23	VDO: 323-803-001-008	Programmable 2	

Dotted Curve of the auxiliary sensor VDO 323-801-012-00		
Point	Resistance	Temperature
1	740	30
2	322	50
3	155	70
4	112	80
5	71	95
6	41	115
7	23	140
8	10	180



TRHESHOLDS				
Parameter	Psw	Description	Default Value	Range
1	2	Three-phase, bi-phase or single-phase without neutral, delta or delta without neutral.	1	0- Three-phase without neutral 1-Three-phase 2-Bi-phase 3- single-phase 4- Delta 5- Delta without neutral
2	2	Maximum Genset Voltage	440V	
3	2	Minimum Genset Voltage	360V	
4	2	Maximum Genset asymmetry value	80V	
5	2	Maximum Genset Frequency	58Hz	
6	2	Minimum Genset Frequency	45Hz	
7	2	Maximum Generator Current	1000 A	
8	2	Short-circuit detection	3000 A	
9	2	Genset Nominal power	200 kW	
10	2	Maximum Inverse Power	10%	0-20%
11	2	Maximum PICK UP speed	1740 rpm	
12	2	Minimum PICK UP speed	1350 rpm	
17	2	Minimum battery voltage	8V (16V)	8-23
18	2	Transfer Fuel Pump: minimum fuel level	30%	15%-40%
19	2	Transfer Fuel Pump: maximum fuel level	80%	70%-90%
20	2	Starting voltage in genset signal	40V	30-100
21	2	Starting voltage in alternator signal	8V (21V)	6-23
22	2	Starting speed (PICK UP)	1000 rpm	300-1000
24	2	Teeth of the engine ring gear	0	0-300
25	2	Fuel reserve level	10%	0..30
26	2	Low oil pressure threshold	1.2 bar	0.5-3
27	2	High water temperature pressure threshold	98°C	80-105
28	2	Low engine temperature by sensor	OFF	OFF(0°C)-40°C
29	2	Minimum heating temperature	25°C	5 - 30 °C
30	2	Maximum heating temperature	35°C	10 - 40 °C
32	2	Activation power of dummy load	OKW	0: Disabled 1...10000
33	2	Deactivation power of dummy load	OKW	0: Disabled 1...10000
34	2	Start-up activation power for load demand	OKW	0: Disabled 1...10000
35	2	Start-up deactivation power for load demand	OKW	0: Disabled 1...10000



ALARMS				
Parameter	Psw	Description	Default Value	Range
1	3	Alarm 0 management High coolant temperature	1	0-Not checked 1-Always checked 2-During starting 3-From starting condition (stabilized) 4- From nominal condition (Running)
2	3	Alarm 0 delay	0"	0" ...5"
3	3	Alarm 0 mode	1	0-Not stop the engine 1-Stop the engine 2-Stop with cooling
4	3	Alarm 1 management Low oil pressure	4	0..4
5	3	Alarm 1 delay	15"	0" ...30"
6	3	Alarm 1 mode	1	0..2
10	2	Alarm 3 management Battery alternator charge failure	3	0..4
11	2	Alarm 3 filter	5"	0" ...30"
12	2	Alarm 3 mode	0	0..2
16	3	Alarm 5 management Low Coolant Level	1	0..4
17	3	Alarm 5 delay	5"	0" ...30"
18	3	Alarm 5 mode	1	0..2
19	2	Alarm 6 management Fuel Reserve	1	0..4
20	2	Alarm 6 delay	5"	0" ...30"
21	2	Alarm 6 mode	0	0..2
22	2	Alarm 7 management Overspeed	4	0..4
23	2	Alarm 7 filter	5"	0" ...30"
24	2	Alarm 7 mode	1	0..2
25	2	Alarm 8 management Underspeed	4	0..4
26	2	Alarm 8 filter	15"	0" ...30"
27	2	Alarm 8 mode	2	0..2
28	2	Alarm 9 management Overload	4	0..4
29	2	Alarm 9 filter	15"	0" ...30"
30	2	Alarm 9 mode	2	0..2
31	2	Alarm 10 management Asymmetry	3	0..4
32	2	Alarm 10 filter	15"	0" ...30"
33	2	Alarm 10 mode	2	0..2
34	2	Alarm 11 management Maximum Genset Voltage	3	0..4



ALARMS				
Parameter	Psw	Description	Default Value	Range
35	2	Alarm 11 filter	5"	0" ...30"
36	2	Alarm 11 mode	1	0..2
37	2	Alarm 12 management Maximum Genset Frequency	4	0..4
38	2	Alarm 12 filter	1"	0" ...30"
39	2	Alarm 12 mode	1	0..2
40	2	Alarm 13 management Erroneous Phase sequence	4	0..4
41	2	Alarm 13 filter	8"	0" ...30"
42	2	Alarm 13 mode	2	0..2
43	2	Alarm 14 management Inverse power	4	0..4
44	2	Alarm 14 filter	15"	0" ...30"
45	2	Alarm 14 mode	2	0..2
46	2	Alarm 15 management Low battery voltage	1	0..4
47	2	Alarm 15 filter	15"	0" ...30"
48	2	Alarm 15 mode	0	0..2
49	2	Alarm 16 management High coolant temperature (by sensor)	1	0..4
50	2	Alarm 16 filter	5"	0" ...30"
51	2	Alarm 16 mode	0	0..2
52	2	Alarm 17 management Low oil pressure (by sensor)	3	0..4
53	2	Alarm 17 filter	5"	0" ...30"
54	2	Alarm 17 mode	0	0..2
55	2	Alarm 18 management Low fuel level (by sensor)	1	0..4
56	2	Alarm 18 filter	5"	0" ...30"
57	2	Alarm 18 mode	0	0..2
58	2	Alarm 19 management Short-circuit	4	0..4
59	2	Alarm 19 filter	—	
60	2	Alarm 19 mode	2	0..2
61	2	Alarm 20 management Minimum Genset Voltage	3	0..4
62	2	Alarm 20 filter	8"	0" ...30"
63	2	Alarm 20 mode	2	0..2
64	2	Alarm 21 management Minimum Genset Frequency	3	0..4
65	2	Alarm 21 filter	8"	0" ...30"
66	2	Alarm 21 mode	2	0..2
70	2	Alarm 23 management Stop Failure	1	0..1



ALARMS				
Parameter	Psw	Description	Default Value	Range
71	2	Alarm 23 filter	5"	0" ...30"
73	2	Alarm 24 management Engine Low Temperature	1	0..4
74	2	Alarm 24 filter	15"	0" ...30"
75	2	Alarm 24 mode	0	0-No condensa CG 1-Condensa CG
76	2	Alarma 25 management Genset voltaje drops	3	0..4
77	2	Alarm 25 filter	2"	0" ...30"
78	2	Alarm 25 mode	2	0..2
79	2	Alarm 26 management Programmable alarm 1	0	0..4
80	2	Alarm 26 delay	0'	0" ...30"
81	2	Alarm 26 mode	0	0..2
82	2	Alarm 27 management Programmable Alarm 2	0	0..4
83	2	Alarm 27 delay	0'	0" ...30"
84	2	Alarm 27 mode	0	0..2
85	2	Alarm 28 management Programmable Alarm 3	0	0..4
86	2	Alarm 28 delay	0'	0" ...30"
87	2	Alarm 28 mode	0	0..2
111	2	Alarm management expansion 1 Programmable alarm 4, (from version PHG6 v250)	0	0..4
112	2	Alarm delay expansion 1	0'	0" ...30"
113	2	Alarm mode expansion 1	0	0..2
114	2	Alarm management expansion 2 Programmable alarm 5 (from version PHG6 v250)	0	0..4
115	2	Alarm delay expansion 2	0'	0" ...30"
116	2	Alarm mode expansion 2	0	0..2
117	2	Alarm management expansion 3 Auxiliary battery alarm (from version PHG6 v250)	0	0..4
118	2	Alarm filter expansion 2	0'	0" ...30"
119	2	Alarm mode expansion 3	0	0..2



PROGRAMMING (I/O)				
Parameter	Psw	Description	Default Value	Range
1	2	Programmable Output Mode 1	0	0- No programmed 1- FR input 2- LOP alarm 3- HCT alarm 4- CL input
2	2	Programmable Output Mode 2	0	5- INT4 input 6- INT5 input 7- EMS alarm 8- INT1 input 9- INT2 input 10- INT3 input
3	2	Programmable Output Mode 3	0	11- Coolant Heater 12- Bloqued Mode 13- Manual Model 14- Auto Mode 15-Test Mode 16- Alternator Alarm 17- Prg Alarm 1 18- Prg Alarm 2 19- Prg Alarm 3 20- Prg Alarm 4 21- Prg Alarm 5 22- Dummy Load 23- Thermal protection
7	2	Input associated to EJP1 Mode	0	0-No programmed 5- INT 4 6- INT 5 8- INT1 9- INT2 10 INT3 17- Expansion INT1 18- Expansion INT2 19- Expansion INT3 20- Expansion INT4
8	2	Input associated to EJP2 Mode	0	
9	2	Input associated to IA Mode	6	
10	2	Input associated to AE Mode	5	
11	2	Input associated to TEST Mode	0	
12	3	Input associated to MFOR Mode	0	
13	2	Input associated to AL1 Mode	0	
14	2	Input associated to AL2 Mode	0	
15	2	Input associated to AL3 Mode	0	
16	2	Input associated to S1 Mode	0	
17	2	Input associated to S2 Mode	0	



PROGRAMMING (I/O) Expansion from PHG6v250 version				
Parameter	Psw	Description	Default value	Range
18	2	Programmable output mode 4 (zero suppressor expansion needed)	0	0- No programmed 1- FR input 2- LOP alarm 3- HCT alarm 4- CL input 5- INT4 input 6- INT5 input 7- EMS alarm
19	2	Programmable output mode 5 (zero suppressor expansion needed)	0	8- INT1 input 9- INT2 input 10- INT3 input 11-Coolant Heater 12-Bloqued Mode 13-Manual Model 14-Auto Mode 15-Test Mode
20	2	Programmable output mode 6 (zero suppressor expansion needed)	0	16-Alternator Alarm 17-Prg Alarm 1 18- Prg Alarm 2 19- Prg Alarm 3 20- Prg Alarm 4
21	2	Programmable output mode 7 (zero suppressor expansion needed)	0	21- Prg Alarm 5 22- Dummy Load 23- Thermal protection
22	2	Input associated to AL4 mode	0	0-No programmed 5- INT 4
23	2	Input associated to AL5 mode	0	6- INT 5 8- INT1 9- INT2 10 INT3 17- Expansion INT1 18- Expansion INT2 19- Expansion INT3 20- Expansion INT4



J1939 CHART				
Parameter	Psw	Description	Default Value	Range
1	3	Engine model	0	0:SCANIA EMS 1: VOLVO EDC4 2:VOLVO EMS2 3:VOLVO EMS1 4: IVECO CURSOR 5: IVECO NEF 6: JOHN DEERE
2	3	Regulation version	0	SCANIA (only reading.): 160- Regulation version 161- Regulation version REST: not available
3	3	Engine speed	0	SCANIA: 0,1:1500 rpm 2:1800rpm 3:slow motion VOLVO: Any writing exchanges speed between 1500 and 1800 rpm. IVECO: 0:1000 rpm 1:1500 rpm 2:1800 rpm
4	2	Speed adjustment	125	Fine adjustment of engine speed
5	3	Speed regulation by analogue input	0	0: Disabled regulation or 1: Enabled regulation



PARAMETERS SET SELECTOR CHART				
Parameter	Psw	Description	Default Value	Range
1	2	Signal Type set 1	1	0- Three phase without neutral 1- Three phase 2- Bi-phase 3- Single phase 4- Delta w/ neutral 5- Delta without neutral 6- Bi-phase selector
2	2	Genset Maximum Tension Set 1	440V	
3	2	Genset Minimum Tension Set 1	360V	
4	2	Generator Maximum Current Set 1	1000A	
5	2	Short-circuit detection Set 1	3000A	
6	2	Genset Minimum Frequency Set 1	58Hz	
7	2	Genset Maximum Frequency Set 1	45Hz	
8	2	Signal Type set 2	1	0- Three phase without neutral 1- Three phase 2- Bi-phase 3- Single phase 4- Delta w/ neutral 5- Delta without neutral 6- Bi-phase selector
9	2	Genset Maximum Tension Set 2	440V	
10	2	Genset Minimum Tension Set 2	360V	
11	2	Generator Maximum Current Set 2	1000 A	
12	2	Short-circuit detection Set 2	3000 A	
13	2	Genset Maximum Frequency Set 2	58Hz	
14	2	Genset Minimum Frequency Set 2	45Hz	



11. (ANNEX III) CEM7 DEVICE DISPLAY. FIGURES AND READINGS

11.1. Status of the device

THE CEM7 STATUS CAN BE READ IN THE DISPLAY AND ALLOWS THE USER TO GAIN ACCESS TO THE DIFFERENT FIGURES AND READINGS BY MEANS OF THE UP/DOWN BUTTONS.

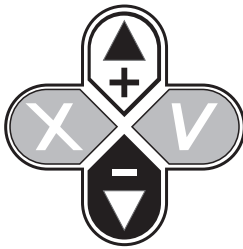

11.1.a. Generator figures displayed

- 1. **Voltage** readings between the different phases, and **neutral phase** and the amperage per **phase, and frequency.**

G E N E R A D O R : 5 0 . 0 H z			
V 1 N	2 3 0 V	I 1	0 A
V 2 N	2 3 0 V	I 2	0 A
V 3 N	2 3 0 V	I 3	0 A

- 2. **Voltage** readings between **phases and the amperage readings in each phase; and frequency.**

G E N E R A D O R : 5 0 . 0 H z			
V 1 2	4 0 0 V	I 1	0 A
V 2 3	4 0 0 V	I 2	0 A
V 3 1	4 0 0 V	I 3	0 A

- 3. **V., A., FL, RPM., P.** readings, The voltage and amperage readings are displayed alternatively. FL fuel level, RPM engine speed. P actual power output.

G E N E R A D O R : 5 0 . 0 H z			
V 1 N	2 3 0 V	I 1	0 A
N C	7 5 %	R P M	1 5 0 0
P	0 k W		



11.1.b. Engine status display

1. **RPM., H., FL, DT, ET, BV,OP**, readings. Readings displayed: RPM engine speed, H working hours, FL fuel level, DT battery charging alternator output voltage, ET engine temperature, BV battery voltage, OP oil pressure.

E N G I N E	:	1 5 0 0 R P M	1 0 0 H
F L		7 5 %	
D T		2 4 V	E T 7 0 ° C
B V		2 4 V	O P 6 . 7 B A R

NOTE: The engine must be provided with the appropriate VDO sensors, in order to visualize the temperature and the oil pressure.
If engine readings are made through extension J1939, the word ENGINE is substitute by the word J1939. Blinking J1939 indicates that engine electronic regulation is active.

NOTE: Only for versions of firmware PHG6v2.51 and higher.
The reading of the tension value of the auxiliary battery carried out by the zero suppressor expansion is done by cyclically switching every 5 seconds with the tension value read on the principal battery.

11.1.c. Control board status display

1. Status of the **programmable alarms**.

```

G E N S E T : S T O P
I A ✓   A E   C K G   C K R ✓   K -
T       F   J P 1   J P 2
I N H I B I T E D   S T A R T
  
```

>CEM7+CEC7

```

G E N S E T : S T O P
I A ✓   A E   C K G   C K R ✓   K -
T       F   J P 1   J P 2
I N H I B I T E D   S T A R T
  
```

>Programmable inputs status

- IA:** Start inhibition

- CKG:** External starting

- CKR:** Loaded activation Relay

- T:** Test function

- F:** Forced Star function

- JP2:** EJP1 function

- JP2:** EJP2 function

11.1.d. Power and energy display.

NOTE: The power display shows the stored power and the date /hour if the programming timer option is available

1. Actual power values and cos. φh̄. per phase.

P O W E R :		F P	1 . 0 0 L
	3 0 k W	F P 1	1 . 0 0 L
	3 0 k V A	F P 2	1 . 0 0 L
	0 k V A R	F P 3	1 . 0 0 L

- FP:** Total power factor.

- FP1:** Phase 1 power factor.

- FP2:** Phase 2 power factor.

- FP3:** Phase 3 power factor.

2. Total consumed power values (day, month, year).

E N E R G Y :	P	3 0 k W h
D		1 0 K W h
M		1 0 0 M W h 1 7 : 5 6 : 2 3
A		1 0 0 0 M W h 4 / 1 2 / 0 6 L

- D:** Accumulated daily power

- M:** Accumulated monthly power.

- A:** Accumulated annual power.



11.2. Failures record

NOTE: The alarms, which cause the engine to stop, are not auto-resetting, and they must be acknowledged and re-set by the user in order for the engine to start again, but only if the alarm does not remain active. The alarms produced by analogical inputs do not stop the engine, they are only warnings.

11.2.a. Failures display

Display readings when a alarm takes place:



E: Alarm / **A:** Warning

N: To be checked

1: Number of position in the total record of errors

3: Number of errors in the record



>Type of failure reading

11.3. Control board maintenance

11.3.a. Introducing password

Switch on the control panel, push Enter button (V) to enter "Menu" screen. Use the (+) and (-) buttons to introduce the password. Select the first number and accept it. Use the same procedure for the 4 numbers.



11.3.b. Main menu.

The main menu display let us to visualize. We have to push (+) (-) buttons and accept it (V) to go in/to navigate on each menu.

1. **Inputs / Outputs**
2. **Parameters (only with authorized code)**
3. **Counters**
4. **Fault History**
5. **Events (only with programming clock option)**
6. **Date/ Hour**
7. **Language**
8. **Password**
9. **Engine Log**





1. Inputs / Outputs

* I N P U T S / O U T P U T S *	
	3 2 1 0 9 8 7 6 5 4 3 2 1
I N :	M S 3 2 1 P I X N A B R
O U T :	C P R 4 B g r 3 2 + 1 M A

- _____ R: Fuel level
- _____ B: Low temperature pressure
- _____ A: High temperature
- _____ N: Coolant level
- _____ X: Programmable input 4.
- _____ I: Programmable input 5.
- _____ P: Emergency stop.
- _____ 1: Programmable input 1.
- _____ 2: Programmable input 1.
- _____ 3: Programmable input 1.
- _____ S: Stop button.
- _____ M: Key start.

* I N P U T S / O U T P U T S *	
	3 2 1 0 9 8 7 6 5 4 3 2 1
I N :	M S 3 2 1 P I X N A B R
O U T :	C P R 4 B g r 3 2 + 1 M A

- _____ A: Active alarm
- _____ M: Engine started
- _____ 1: Programmable output 1.
- _____ +: D+
- _____ 2: Programmable output 2.
- _____ 3: Programmable output 3.
- _____ r: Mains contactor
- _____ g: Generating set contactor.
- _____ B: Fuel transfer/Heating
- _____ 4: Programmable output 4.
- _____ R: PR/PD (PR output)
- _____ P: PD/PE (PC output)
- _____ C: Controller fitting.

A N A L O G		I N P U T S	
N C	0 . 0	P A	0 . 0
T M	0 . 0	A A	0 . 0
D I	0 . 0 V	V B	0 . 0 V

- _____ FL: Fuel level
- _____ OP: Oil pressure
- _____ ET: Engine Temperature
- _____ AA: Auxiliary analog
- _____ DI: Dinamo Voltage
- _____ BV: Battery Voltage

2. Visualization of engine status J1939

* J 1 9 3 9 *	
N A :	1 0 0 % P T : 0 . 6 b a r
F R :	6 L / h V B : 2 4 . 2 V
F U :	1 2 0 0 L h

- _____ NA: Fuel level
- _____ PT: Turbo-pressure
- _____ FR: Average fuel consumption
- _____ FU: Total fuel consumption
- _____ VB: Battery tension
- _____ h: Number of engine working hours

NOTE: Engine status display only appears in gensets with extension J1939 (see section 8.4 J1939). Variables shown depend on the engine model installed.



3. Counters



```

* * * *   C O U N T E R S   * *
→ Total hours      0 1 : 0 0 :
  Biased  hours 0 0 : 1 0 :
▼ Normal start ups 1

```

```

* * * *   C O U N T E R S   * * *
→ Fail to start ups
▲ Total              5 0 k W
▼ At present        1 0 k W

```

```

* * * *   C O U N T E R S   * * * *
→ Day                2 0 k W h
▲ Month              5 0 M W h
▼ Year               1 0 0 M W h

```

```

* * * *   C O U N T E R S   * * * *
→ Maint. # 1         ! 0 : 0 0
▲ Maint. # 1         1 5 0 : 0 0
▼ Rental             1 : 0 4

```

Partial counters can be reset by pushing the RESET button for 5 seconds.

4. List of failures

When the historical menu is selected we can select any of the present historical pushing accept button (V). The control panel will show us the condition/state of the generating set when the alarm started, with the (+)(-) buttons can check / visualize the different screens.

```

* L I S T   O F   F A I L U R E S   *
→ 1 . M A I N S   M A X   V O L T A G E
  2 . M A I N S   M I N   V O L T A G E
▼ 3 . M A I N S   M A X   F R E Q U E N

```



5. Events

The programming of events in the CEM7 control panel is determined by the activation of the programming-timer. The programming of events is carried out from the fifth option in the maintenance menu.

```
* * * * * M E N U * * * * *
-> 5 . E v e n t s
▲ 6 . D a t e / T i m e
▼ 7 . L a n g u a g e
```

Programming procedure (programming timer option is required, see expansion attachment). The CEM7 device needs to have the programming timer option installed if the user wants to programme its working. In case the programming-timer option is not detected, the control panel will show the following message:

```
* * * * * E V E N T S * * * * *
R T C N O T A V A I L A B L E
```

Events are programmed to be repeated one day per week. To go into each menu we have to use the (+)(-) buttons and accept (v).



```
* * * * * E V E N T S * * * * *
-> M o n d a y
   T u e s d a y
▼ W e d n e s d a y
```

```
* * * * * E V E N T S * * * * *
-> T h r u s d a y
▲ F r i d a y
▼ S a t u r d a y
```

```
* * * * * E V E N T S * * * * *
-> S u n d a y
▼
```

The possible events to be programmed are (following a priority order):

- **Locked (BLOQ):** Blocks the genset start up and also the counter functions.
- **Forced Start (ARRF):** Starts the genset and activates the contactor.
- **Test (TEST):** Starts the genset without activation of the contactor; in case of external start (CEM7+CEC7).
- **Free (----):** No events are programmed for this range; the start and finish time have no effect.

This programming-timer option can program 5 different events for one day. For each event there is an activation range indicating the time and exact minute when the event starts and finishes; the starting time must be always previous to the finishing time. Starting and finishing time are included between 00:00h and 23:59h.

Select day and accept (V), condition (v), start hour (V), start minutes(V), stop hour (V), stop minutes (V).

To select program 2-3-4-5 use (+)(-) and repeat the before/previous process.

```
* * * * * M o n d a y * * * * *
-> B L O Q 1 0 : 0 0 . . . 1 1 : 0 0
   A R R F 1 5 : 5 0 . . . 1 7 : 0 0
▼ T E S T 2 0 : 0 0 . . . 2 2 : 0 0
```

>Type of event: Start time

```
* * * * * M o n d a y * * * * *
-> B L O Q 1 0 : 0 0 . . . 1 1 : 0 0
   A R R F 1 5 : 5 0 . . . 1 7 : 0 0
▼ T E S T 2 0 : 0 0 . . . 2 2 : 0 0
```

>Type of event: Finish time

To programme an event for two consecutive days in the week (i.e from Monday 22:00h to Tuesday 03:00h), the event must be programmed to finish at Monday 23:59 and the same event starting at Tuesday 00:00h.

```
* * * * * M o n d a y * * * * *
-> B L O Q 2 2 : 0 0 . . . 2 3 : 5 9
   - - - - 0 0 : 0 0 . . . 0 0 : 0 0
▼ - - - - 0 0 : 0 0 . . . 0 0 : 0 0
```

```
* * * * * T u e s d a y * * * * *
-> B L O Q 0 0 : 0 0 . . . 0 3 : 0 0
   - - - - 0 0 : 0 0 . . . 0 0 : 0 0
▼ - - - - 0 0 : 0 0 . . . 0 0 : 0 0
```



6. Data / Hour

Select day and accept (V), condition (v), start hour (V), minutes(V), stop hour (V), stop minutes (V).

To select program 2-3-4-5 use (+)(-) and repeat the before/previous process.

```
* * *   D A T A       /   H O U R   * * *  
→ H o u r :         1 1 : 0 0 : 5 5  
  D a t a :         1 0 / 1 2 / 0 6   D
```

7. Language selection

To go into each menu we have to use the (+)(-) buttons and accept (v).

```
* * *           L A N G U A G E           * * *  
→ 0 . S p a n i s h  
  1 . F r a n c a i s  
  2 . E n g l i s h
```

```
* * *           L A N G U A G E           * * *  
→ 1 . E n g l i s h  
▲ 2 . F r a n c a i s  
▼ 3 . I t a l i a n
```

- 0. Español
- 1. English
- 2. Francais
- 3. Italian
- 4. Portuguese
- 5. Polish
- 6. German
- 7. Русский
- 8. 中文
- 9. Finnish



8. Password configuration

To go into each menu we have to use the (+)(-) buttons and accept (v).

```
* * * * P A S S W O R D * * * *  
-> 0 . U s e r  
1 . M a i n t e n a n c e
```

```
* * * * U S E R * * * *  
P a s s w o r d  
1 1 1 1  
0 0 0 0
```

> Old password

```
* * * * U S U A R I O * * * *  
P a s s w o r d  
1 1 1 1  
0 0 0 0
```

>New password

9. Engine Log

```
* M E N U *  
-> 1 . E r r o r l i s t  
2 . S t a r t i n g l i s t
```

NOTE: The Engine Log Display only appears in those genstes that have intalled the J1939 expansion (see section 8.7 J1939). The variables that appear depend on the model of engine installed.



11.4. Error list J1939

From the J1939 option, you can visualize the passive and active error log saved in the electronic regulation of the engine.

To identify the code shown on the display, you are referred to the engine manual where the description of the alarm is.



> Number parameter



> Error code

NOTE: To identify the code shown in the display, use the manual of the engine where it appears the description of the alarm



> Error code

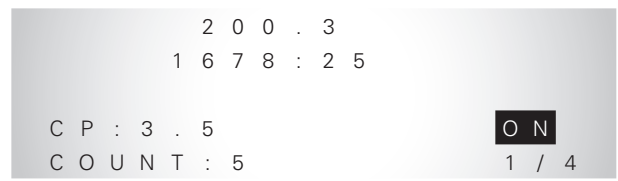

> Error status



> Engine working hours



> Blinking code



> Error counter

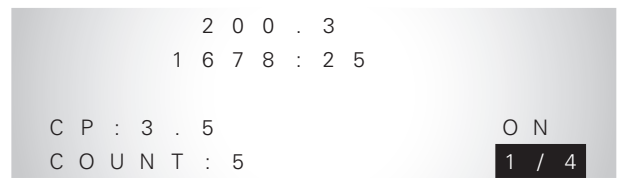

> Error index



11.5. Start list J1939

From the option J1939, you can visualize the starts made from the J1939 expansion in autonomous mode.

```
* S T A R T I N G L I S T *
  1 6 7 8 : 2 5
                               1 / 4
```

> Engine working hours

```
* S T A R T I N G L I S T *
  1 6 7 8 : 2 5
                               1 / 4
```

> Index of starts

11.6. Control board programming.

To go into each menu we have to use the (+),(-) buttons and accept (v).

The access of the main menu is restricted to, at least, a password of the maintenance level.

```
* * * * P A R A M E T E R S * * * *
-> 1 . M e a s u r e m e n t s
   2 . T i m e s
▼ 3 . R e g u l a t i o n s
```

```
* * * * P A R A M E T E R S * * * *
-> 4 . U m b r a l e s
▲ 5 . A l a r m s
▼ 6 . P r o g r a m a t i o n I / O
```

```
* * * * P A R A M E T E R S * * * *
-> 7 . T e x t s
▲ 8 . I d e n t i f i c a t o r
▼ 9 . S e l e c t o r
```

```
* * * * P A R A M E T E R S * * * *
-> 10 . J 1 9 3 9
▲ 11 . C C L A N
▼ 12 . S e n s o r s
```

```
* * * * M E A S U R E M E N T S * * * *
-> P 0 1 . . . . . 4
▲ P 0 2 . . . . . 5
▼ P 0 3 . . . . . 0
```

>Nº parameter

```
* * * * M E A S U R E M E N T S * * * *
-> P 0 1 . . . . . 4
▲ P 0 2 . . . . . 5
▼ P 0 3 . . . . . 0
```

>Value

11.7. Texts

We can assign a text to the programmable inputs, maximum 15 characters. The device has an A-Z alphabet and 0-9 numbers.



```
* * * * T E X T S * * * *
-> 1 . P R O G R A M M A B L E 1
   2 . P R O G R A M M A B L E 2
▼ 3 . P R O G R A M M A B L E 3
```



```
* * * * T E X T S * * * *
-> 4 . D I S P L A Y
▼
```



11.8. Text personalization of the programmable alarms

From the option of Controller texts programming, the personalization of the texts associated to the programmable alarms is allowed.

11.9. Personalization of manufacturer's screen

From the option of Controller texts programming, the personalization of manufacturer's screen is allowed.

We can associate a text with the programmable incoming, 15 characters maximum. The control panel has an alphabet (A-Z) and numbers (0-9).



11.10. CCLAN



By pushing the key  for 5 seconds, you will return to the default values of the communication parameters for the CCLAN option. Once you have requested the return to the default values, the CCLAN text of the parameters menu will flash until the option CCLAN has loaded the default values of the communication parameters.

11.11. Sensors slope programming

NOTE: Starting from central versions of firmware: Display 3.21 / Measurements 2.51. The parameters option allows the programming of two response curves applicable to the temperature and pressure sensors.



The programming of the sensor response curves will be done by entering the points in decreasing values of resistance.

For curve 1 associated to the temperature sensors, positive and negative temperature values are allowed; for curve 2 associated to the pressure sensors, only positive pressure values are allowed.

The maximum number of points is 8 per programmed curve. With the cursors (+) (-) select each new point and enter the resistance value, with the range of values limited between 0 and the resistance value of the previous point. Once the resistance value is entered, push the accept key and enter the value associated with this resistance. Once the curve programming is finished, hold down the validate (V) key for 5 seconds after entered the value of physical units of the point; if you want to program a new point of the curve, push the validate (V) key.

Once completed the programming process of the curve, you automatically return to the sensor menu.



11.12. Table Access to menus

MENU		CEM	CEA	CEC	
				Integrated	External
MAINTENANCE	Inputs/Outputs	✓	✓	✓	✓
	Counters	✓	✓	✓	
	Error list	✓	✓	✓	✓
	Hours	✓	✓	✓	✓
	Date/Time	✓	✓	✓	✓
	Languages	✓	✓	✓	✓
	Password	✓	✓	✓	✓
	Motor historial	✓ ⁽¹⁾	✓ ⁽¹⁾		
	Synchronization			✓ ⁽²⁾	
PARAMETERS	Measurements	✓	✓	✓	✓
	Times	✓	✓	✓	✓
	Regulations	✓	✓	✓	✓
	Ranges	✓	✓	✓	✓
	Alarms	✓	✓	✓	✓
	I/O Programming	✓	✓	✓	✓
	Texts	✓	✓	✓	✓
	Equipment list	✓	✓	✓	✓
	Selector	✓ ⁽³⁾			
	J1939	✓ ⁽¹⁾	✓ ⁽¹⁾		
	CCLAN	✓	✓		
	Sensors	✓	✓		
	Synchronization			✓ ⁽²⁾	
	Second Zero			✓ ⁽²⁾	

(1) Detected expansion presence J1939.

(2) Detected expansion presence Second Zero.

(3) Without switchboard modules associated.

NOTE: Access to the tables in the menu of parameters will vary based on the presence of expansion modules and the programming for the work center.



12. (ANNEX IV) DIMENSIONS, CONNECTIONS AND MECHANIZATION

12.1. Measures module

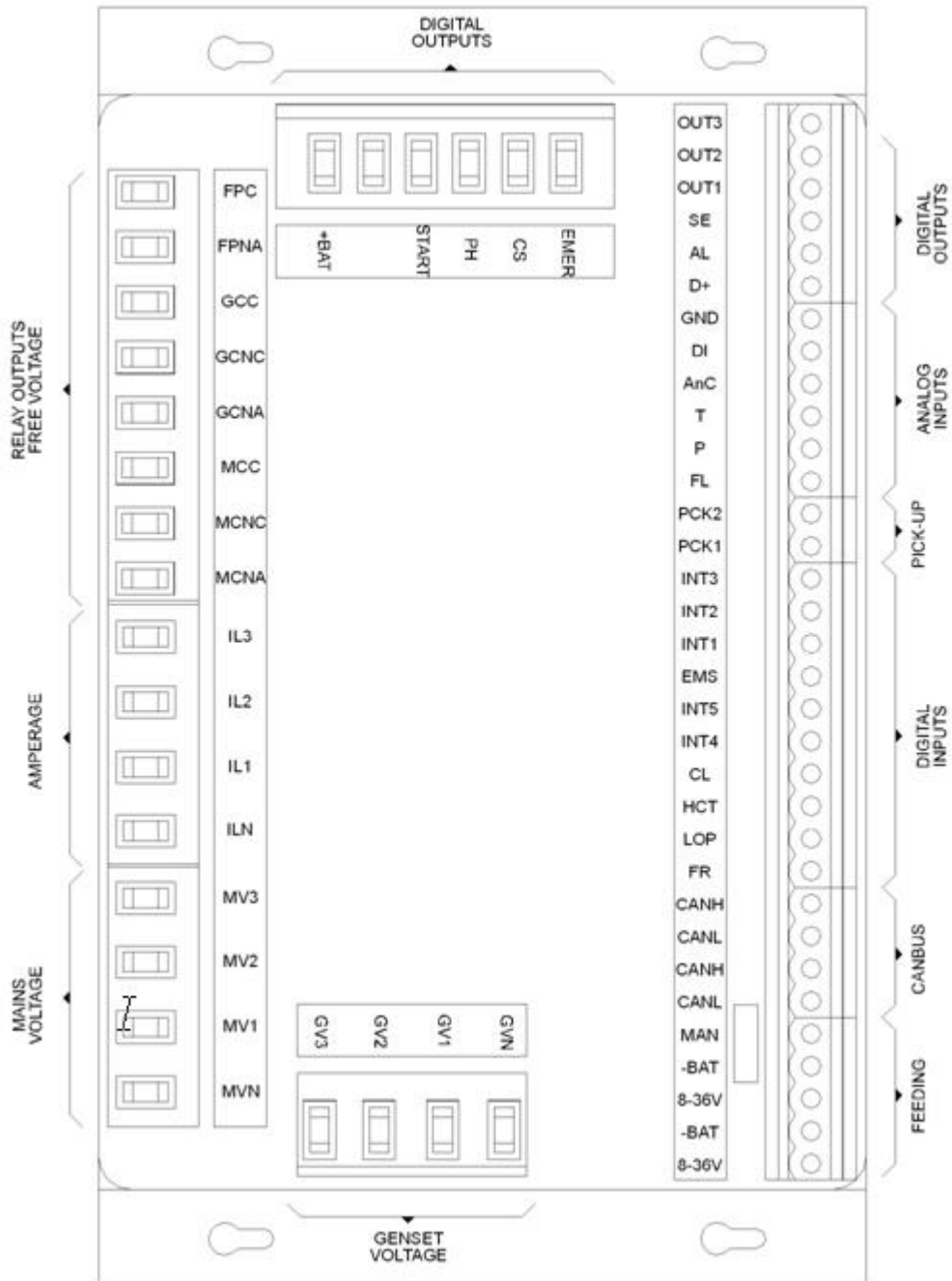

Figure 1. Measurement module connections.

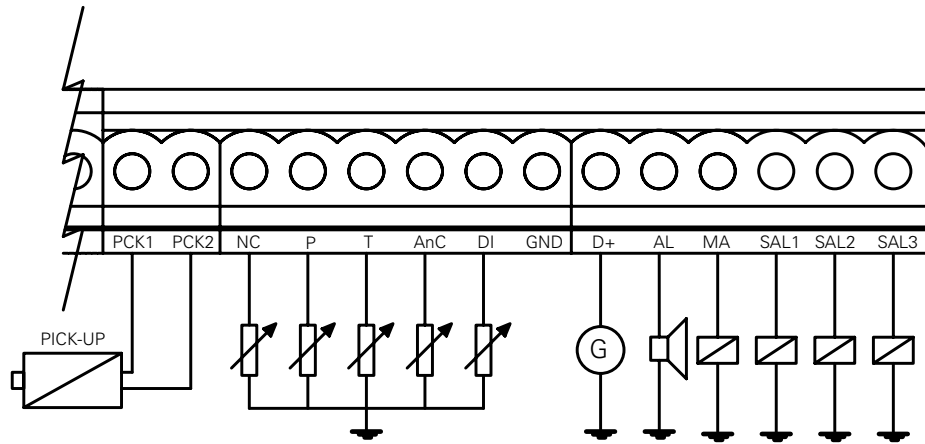

Figure 2. Measurement module connections section 1.

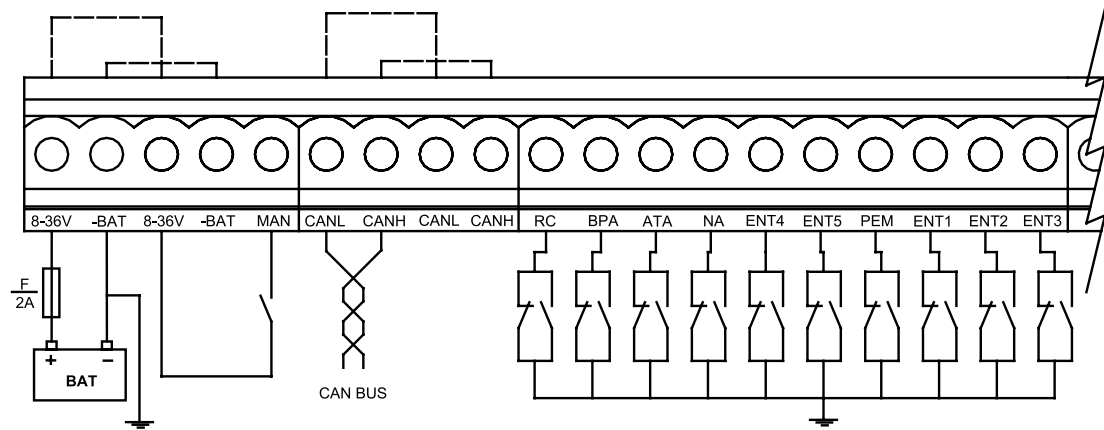

Figure 3. Measurement module connections section 2.

To feed the badge it is advisable to use a cable of section 1 mm².

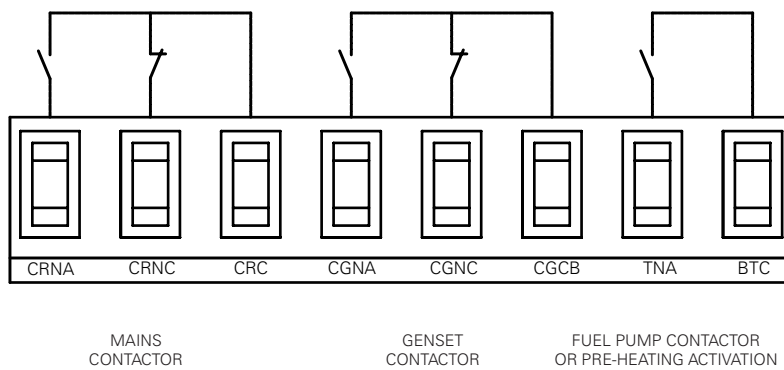

Figure 4. Measurement module connections section 3.

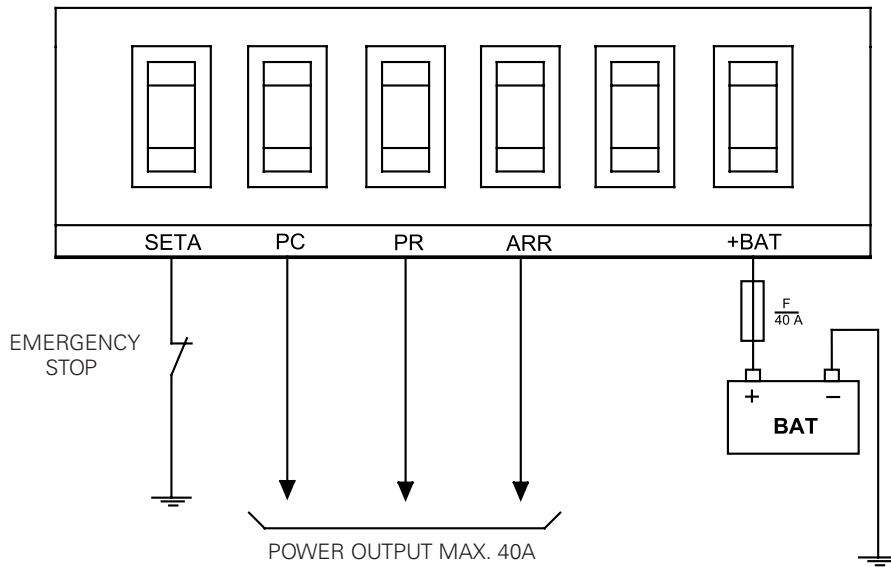
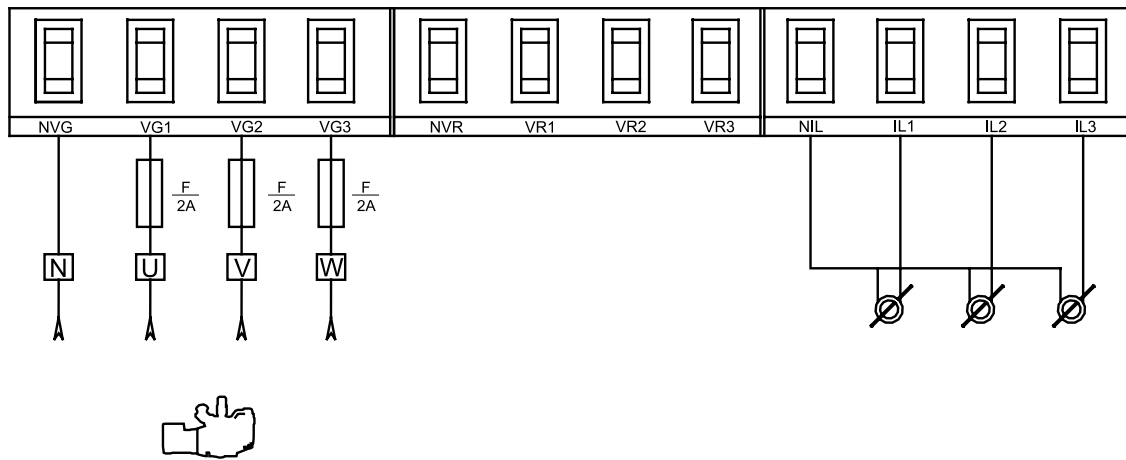

Figure 5. Measurement module connections section 4.



 The equipment should be insulated or disconnected before making this connection. There is risk of danger.

Figure 6. Measurement module connections section 5.



SIGNAL		TYPE	CHARACTERISTICS
8÷36V	Battery positive	Feeding	Feeding device voltage from 8 to 36 V
-BAT	Battery negative	Feeding	Negative device feeding
MAN	Manual	Input	Digital input of starting PNP
CANL	CANL line CAN bus	Bus	CAN communication
CANH	CANH line CAN bus	Bus	CAN communication
FR	Fuel reserve	Input	NPN digital input
LOP	Low oil pressure	Input	NPN digital input
HCT	High coolant temperature	Input	NPN digital input
CL	Coolant level	Input	NPN digital input
ES	External start	Input	NPN digital input
IS	Inhibited starting	Input	NPN digital input
EMS	Emergency stop	Input	NPN digital input
INT1	Input 1	Input	NPN digital input
INT2	Input 2	Input	NPN digital input
INT3	Input 3	Input	NPN digital input
PCK1	Pick-up	Input	High speed digital input PICK-UP
PCK2	Pick-up	Input	High speed digital input PICK-UP
FL	Fuel level	Input	Digital input of resistive sensor
P	Pressure	Input	Digital input of resistive sensor
T	Temperature	Input	Digital input of resistive sensor
AnC	Analog auxiliary input (ex. Oil Temperature)	Input	Digital input of resistive sensor
DI	Alternator voltage	Input	Analog voltage input 0-40V
GND	Sensors	Input	Negative to 2 terminals sensors type
D+	Alternator excitation	Output	PNP digital input
AL	Alarm	Output	PNP digital input
SE	Started engine	Output	PNP digital input
OUT1	Output 1	Output	PNP digital input
OUT2	Output 2	Output	PNP digital input
OUT3	Output 3	Output	PNP digital input
EMER	Emergency button (SETA)	Output	NPN digital input
CS	Configurable stop	Output	Power PNP digital input
PH	Pre-heating	Output	Power PNP digital input
START	Starting	Output	Power PNP digital input
OUT4	Output 4	Output	Power PNP digital input
+BAT	Battery positive	Feeding	Digital inputs feeding voltage
FPC	Fuel pump	Output	Fuel pump relay, C contact
FPNA	Fuel pump	Output	Fuel pump relay, NA contact
GCC	Genset contactor	Output	Genset contactor relay, C contact
GCNC	Genset contactor	Output	Genset contactor relay, NC contact
GCNO	Genset contactor	Output	Genset contactor relay, NO contact
MCC	Mains contactor	Output	Mains contactor relay, C contact
MCNC	Mains contactor	Output	Mains contactor relay, NC contact
MCNO	Mains contactor	Output	Mains contactor relay, NO contact
IL3	Phase 3 amperage	Input	Amperage measurement analog input
IL2	Phase 2 amperage	Input	Amperage measurement analog input
IL1	Phase 1 amperage	Input	Amperage measurement analog input
ILN	Shared amperage	Input	Amperage measurement analog input
MV3	Phase 3 mains voltage	Input	Voltage measurement analog input
MV2	Phase 2 mains voltage	Input	Voltage measurement analog input
MV1	Phase 1 mains voltage	Input	Voltage measurement analog input
MVN	Neutral mains voltage	Input	Voltage measurement analog input
GV3	Phase 3 genset voltage	Input	Voltage measurement analog input
GV2	Phase 2 genset voltage	Input	Voltage measurement analog input
GV1	Phase 1 genset voltage	Input	Voltage measurement analog input
GVN	Neutral genset voltage	Input	Voltage measurement analog input

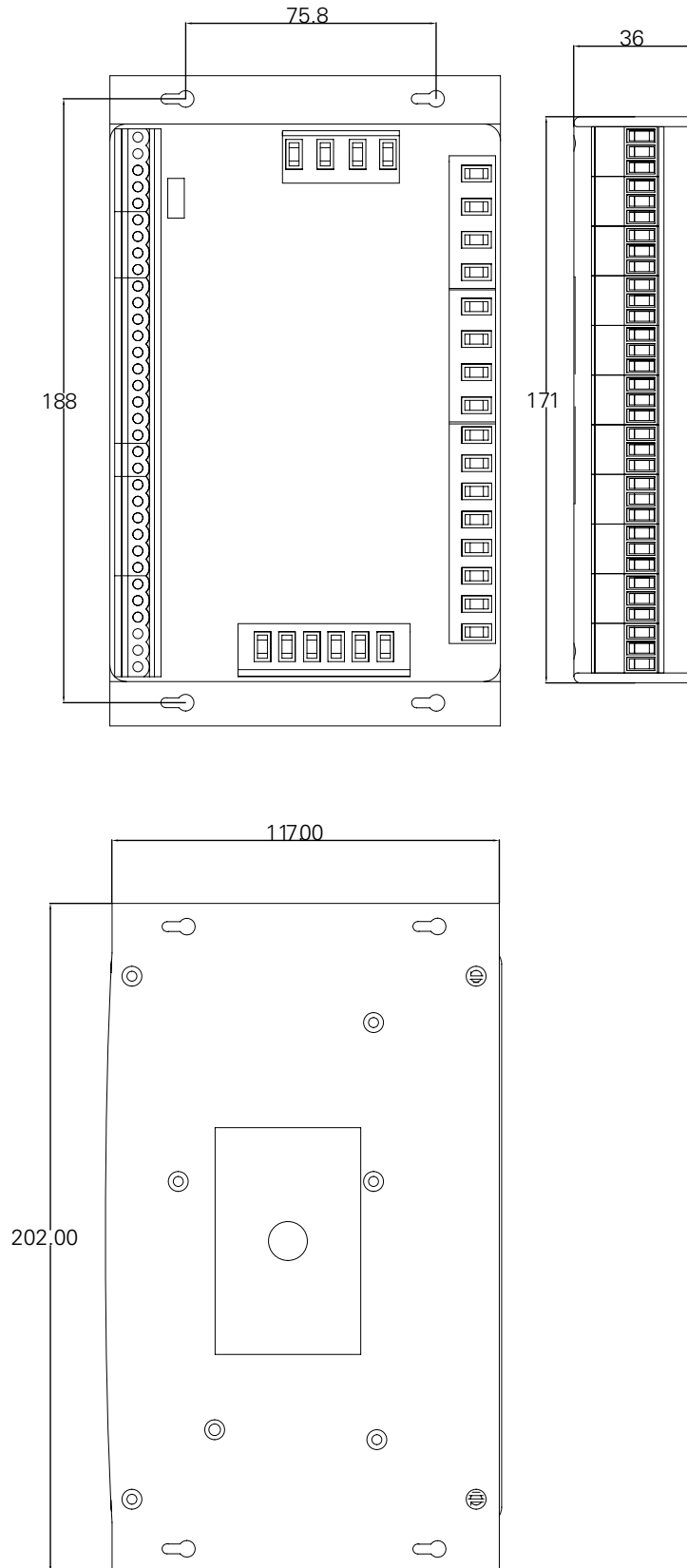



Figure 7. Measurement module dimensions.

12.2. Módulo de visualización

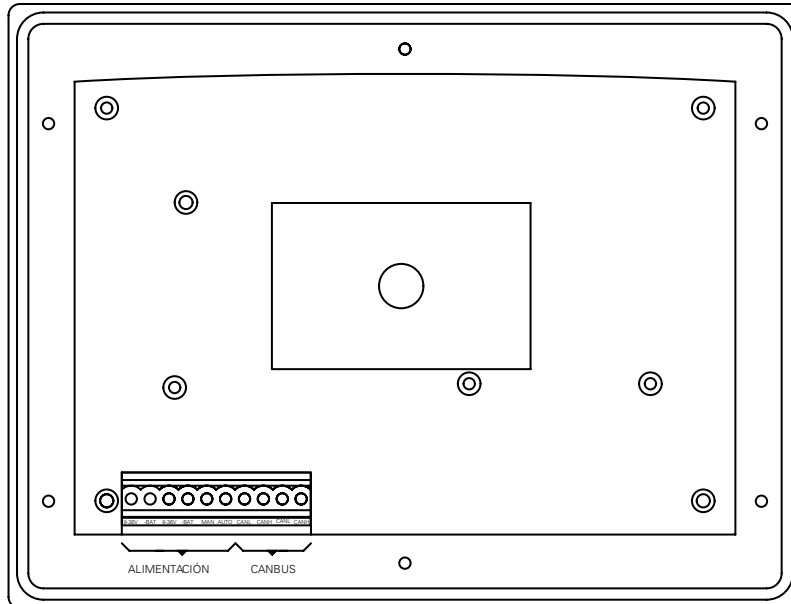

Figure 8. Visualization module

To feed the badge it is advisable to use a cable of section 1 mm².

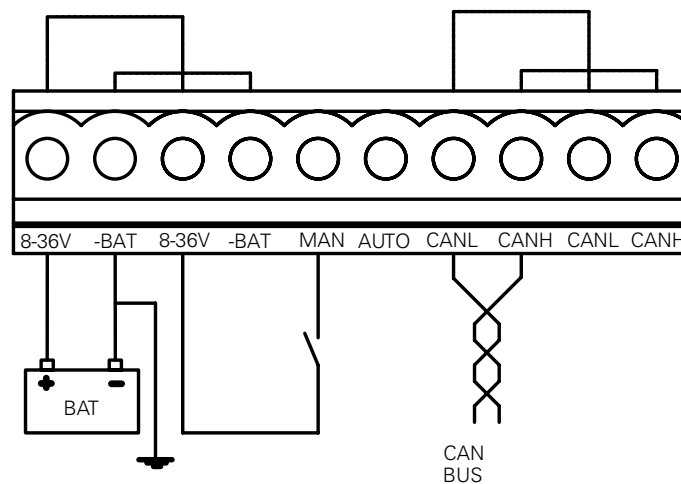

Figure 9. Visualization module connections

SIGNAL	DESCRIPTION	TYPE	CHARACTERISTICS
8÷36V	Battery positive	Feeding	Feeding device voltage from 8 to 36 V
-BAT	Battery negative	Feeding	Negative device feeding
MAN	Manual	Input	Digital input PNP
AUTO	Automatic	Input	Digital input PNP (Unused)
CANL	CANL line bus CAB	Bus	CAN communication
CANH	CANL line bus CAB	Bus	CAN communication

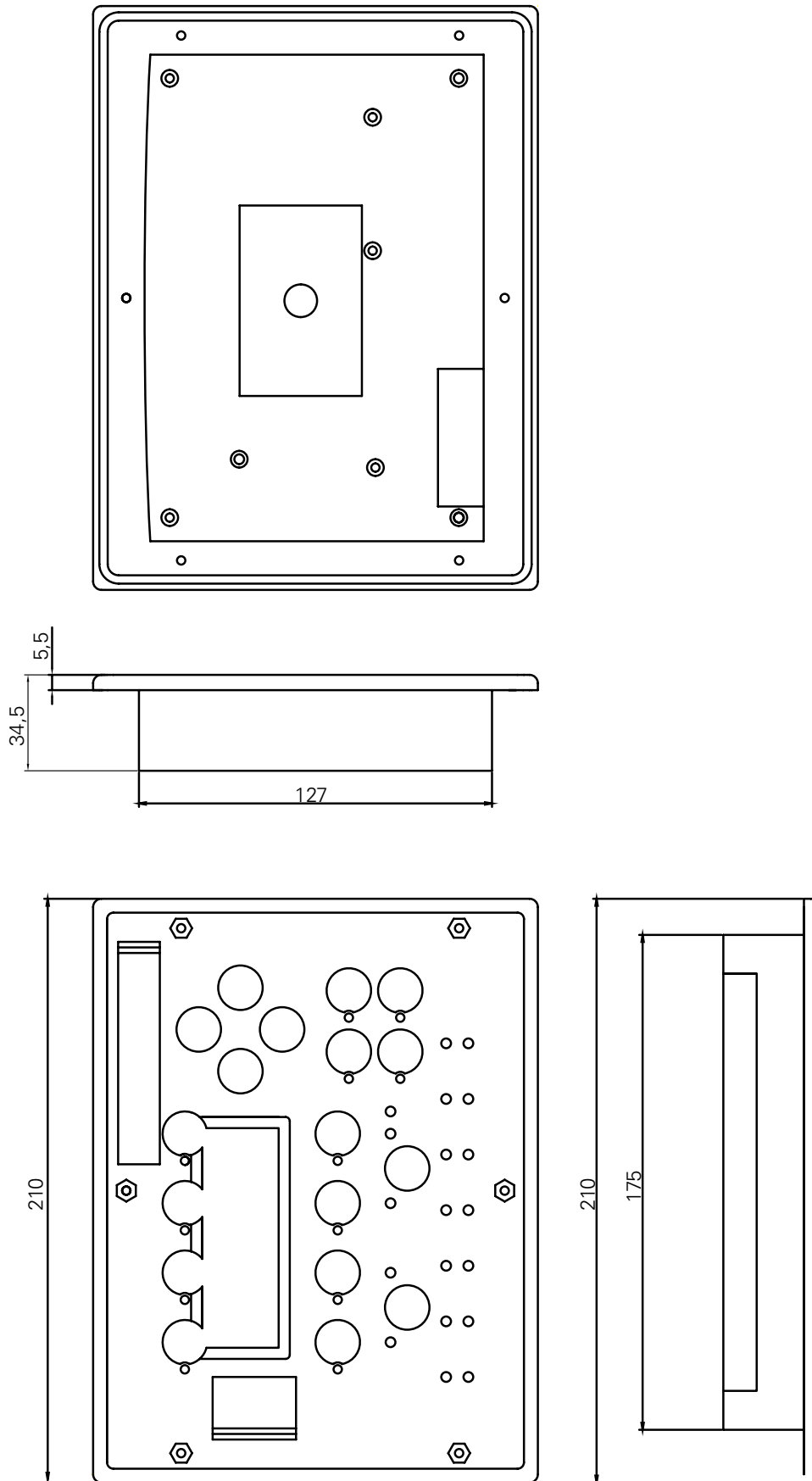

Figure 10. Visualization module dimensions



12.3. Electric characteristics

Symbol	Parameter	Conditions	Min	Usual	Max	Unit
Feeding (terminals 8÷36V, -BAT, +BAT)						
8÷36V	Power supply voltage of the unit				36	VDC
+BAT	Power supply voltage of the outputs				36	VDC
I_{BAT}	Feeding force				100	mA
I_{BAT}	Feeding force				50	mA
P_{BAT}	Power consumption				1,2	W
CAN Bus (terminals CANL, CANH)						
V_{IN}	CANH y CANL input voltage				+40	V
DR_{CAN}	Transmission speed			50		Kbps
L_{CAN}	Bus length				500	m
Nodes	Number of nodes on the bus				20	nodos
Digital inputs PNP (terminals MAN)						
V_{IN}	Voltage input				40	V
V_{IL}	Low level voltage input				1	V
V_{IH}	High level voltage input					V
I_{IL}	Low level power supply voltage			0	100	µA
I_{IH}	High level power supply voltage			0,8	1	mA
Digital inputs NPN (terminals FR, LOP, HCT, CL, ES, IS, EMS, INP1, INP2, INP3, SETA)						
V_{IN}	Low level voltage input				40	V
V_{IL}	High level voltage input				1	V
V_{IH}	Low level power supply voltage					V
I_{IL}	High level power supply voltage			2	2,5	mA
I_{IH}	Low level voltage input			0	100	µA
High speed digital inputs (terminals PCK)						
V_{IN}	Input voltage				30	VAC
I_{IN}	Input power supply	VIN=12VAC		2,6	3	mA
F_{IN}	Input frequency	VIN=12VAC		3600		Hz
Analog inputs (terminals FL, P,T, AnC=TC, DI, GND)						
V_I	Voltage input				5	V
R_{NC}	Fuel level resistance		0		400	Ω
R_P	Pressure resistance		0		200	Ω
R_T	Coolant temperature resistance		0		4000	Ω
R_{TC}	Oil temperature resistance		0		4000	Ω
DI	Alternator voltage		0		40	V



Symbol	Parameter	Conditions	Min	Usual	Max	Unit
PNP outputs (terminals D+, AL,SE, OUT1, OUT2, OUT3)						
V_o	Output voltage			+BAT		V
I_o	Output amperage				1	A
R_{D+}	D+ output resistance			47		Ω
Power PNP outputs (terminals CS, PH, START, OUT4)						
V_o	Output voltage			+BAT		V
I_o	Output power supply	$T = \infty$			20	A
I_o	Output power supply	$T = 1s$			40	A
Relay outputs (terminals MRNA, MRNC, MRC, GCNA, GCNC, GCC, BTNA, FPC)						
V_o	Relay contactors maximum voltage				250	VAC
I_o	Relay contactors power	$\cos\varphi = 0$			8	A
Amperage values analog inputs (terminals ILN, IL1, IL2, IL3)						
I_{IN}	Input feeding power				5	AAC
R_{IN}	Input resistance			0,05		Ω
Voltage measurements analog inputs (terminals MVN, MV1, MV2, MV3, GNV, GV1, GV2, GV3)						
V_{IN-FF}	Phase to phase voltage input				600	VAC
V_{IN-FN}	Phase to neutral voltage input				350	VAC
R_{IN}	Input resistance			1		M Ω



13. (ANNEX V) GENERAL CONSIDERATIONS, CHARACTERISTICS AND INSTALLATION OF THE EQUIPMENT

THE FOLLOWING INFORMATION
IS COMPLEMENTARY TO THE
EQUIPMENT DOCUMENTATION:

13.1. General considerations

It is necessary to consult the documentation.

13.2. Characteristics

The equipment has been designed to be safe within the following range of environmental conditions:

- the exchanges should be assembled inside a switchboard which is used outdoors.
- work temperature $-20^{\circ}\text{C} \sim +70^{\circ}\text{C}$
- maximum relative humidity of 80% (without condensation).

13.3. Installation

The equipment is included within the CAT III 600V category for measurements made in the building installation.

For the correct protection of the equipment include the following elements in the switchboard (see wiring)

Connect the grounding connection to the negative point of the battery, to the switchboard chassis and to the generating sets chassis.



14. (ANNEX VI) CAN COMMUNICATIONS

14.1. Introduction

The **CAN** bus is a powerful and reliable industrial bus that ensures the efficient communication between the devices in the environments full of electric disturbances. The devices provided with **CAN** controller can be integrated into an industrial system of control and automation.

The most important characteristics of a control system with **CAN** bus communication are the following:

- It is possible to connect up to 110 devices in a single **CAN** network.
- Each network can reach a length of 1000 meters, easily extended (up to 2000 meters) with the use of bridges or repeaters.
- **CAN** bus transmission speed 50 Kbits/s (for 1000 meters bus: 10 ms of data updating).
- Direct access to the **CAN** bus from a PC by means of a **USBCan**.

The Can bus is prepared to work in extreme conditions of noise and interferences and at the same time, the failure checking mechanisms guarantee that the frames affected by the disturbance can be detected.

The **CAN** bus is designed to continue the communication even if:

- Any of the two bus wires cuts.
- Any cable is short-circuited to earth.
- Any cable is short-circuited to feeding.

14.2. Topology

The Can network uses a bus topology in which each node has an input and an output connection, The endpoint nodes of the bus must have a 120Ω terminator: this terminator is activated by means of a switch in each module (ON: enabled terminator, 1: disabled terminator). In each case, the impedance found between the CANH and CANL must be, approximately, 60Ω . To do so, in each network endpoint a resistance value must be defined to guarantee such impedance value from every connected device.

NOTE: The impedance measurement must be obtained when all the equipments are not working or they have not physical access from the network. For more information it is recommended to consult the ISO11898 standards and the different applications notes.

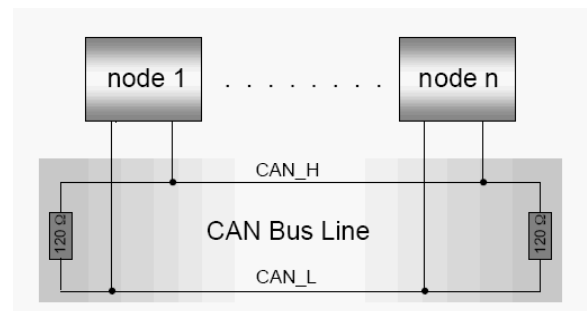



14.3. Wiring

The can network needs a wiring depending of the distance, the speed transmission, and the number of nodes connected to the bus.

Bus length	Wire characteristics	
	Length/resistance	Diameter
0 m..40 m	70 mΩ/m	0,25 mm ² ..0,34 mm ² AWG23,AWG22
40 m..300 m	<60 mΩ/m	0,34 mm ² ..0,6 mm ² AWG22,AWG20
300 m..600 m	<40 mΩ/m	0,5 mm ² ..0,6 mm ² AWG20
600 m..1 Km	<26 mΩ/m	0,75 mm ² ..0,8 mm ² AWG18

Table 1. Wire characteristics according the distance.

Bus length	Number of nodes		
	32	64	100
100 m	0,25 mm ²	0,25 mm ²	0,25 mm ²
250 m	0,34 mm ²	0,50 mm ²	0,50 mm ²
500 m	0,75 mm ²	0,75 mm ²	1,00 mm ²
Resistencia cable	<21Ω	<18,5Ω	<16Ω

Table 2. Wire characteristics according the number of nodes.

In order to connect the different nodes of the network a twisted pair without shielding is needed. As an exception, the connection between the measurement and the visualization module can be done using a wiring not twisted.

In very noisy environments affected by high electromagnetic interference (**EMI**), a twisted shielded wire with the shield connected to earth can be used. Other technique to improve the immunity against the electromagnetic interference consists in substituting the **CAN** terminator of the node for 2 resistances of 62Ω and installing a decoupling capacitor between the resistances **CAN** and the battery negative.



Table 3. Protection technique against electromagnetic interferences: Decoupling capacitor.



14.4. Wiring diagrams

Example 1: Connection example in devices CEM7 and CEA7.

Between visualization module and the measures module. The two switch of end of bus are in the position ON.

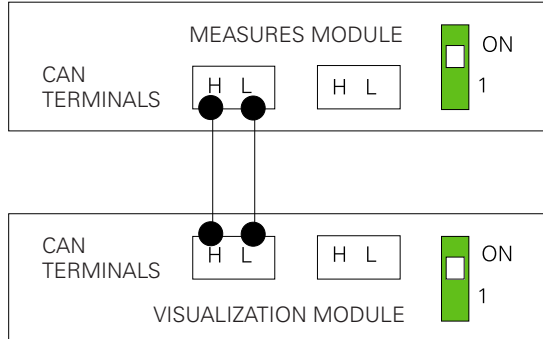

Example 2. Connection example in devices CEM7 with CEC7

The two switch of end of bus (Visualization module) are in the position ON. The others in position 1.

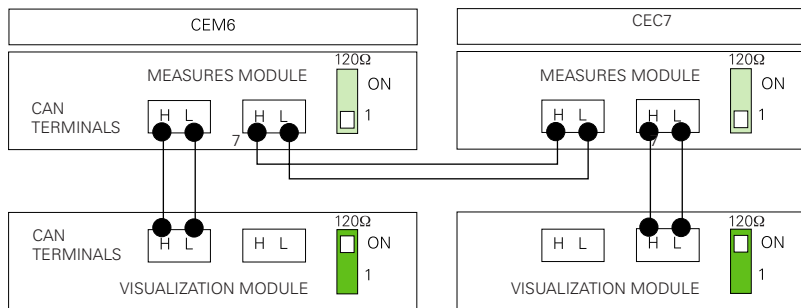

Example 3. Connection among a device CE and communications module.

In this case the line ends would be the visualization module and communications module (CCRS) that will have the switch in the position ON.

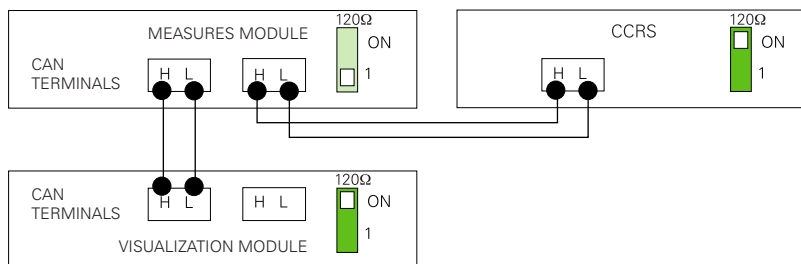



Example 4. Connection among a device CE and a communications module.

In this case the line ends would be the visualization module and communications module (USB/CAN) that will have the switch in the position ON.

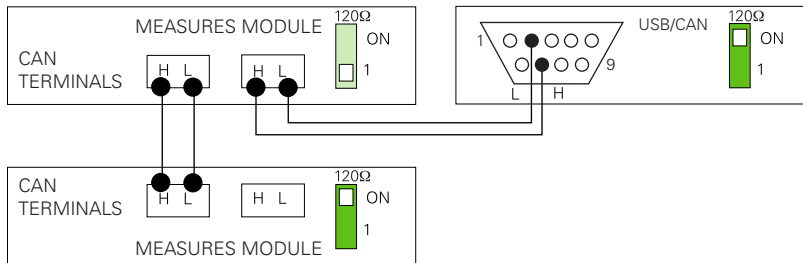

Example 5. Connection example in devices CEM7 with CEC7 and a communication module CCRS.

In this case the line ends would be the visualization module CEM7 and communications module (CCRS) that will have the switch in the position ON.

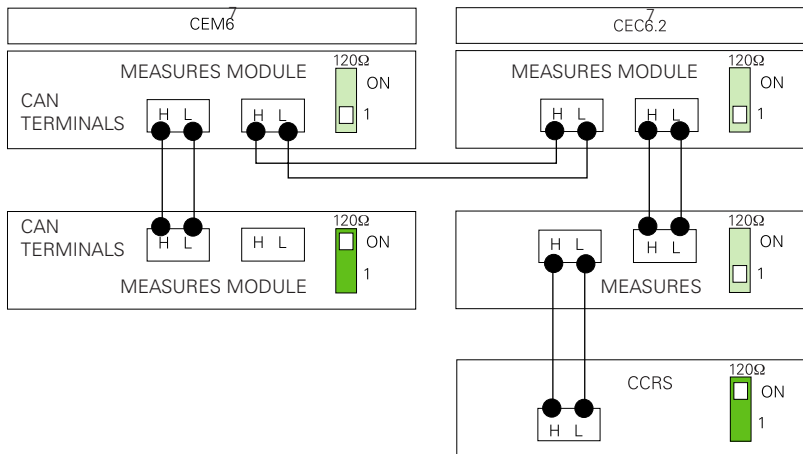



15. (ANNEX VII) TELESIGNAL: COMMUNICATION OPTION BY DIGITAL OUTPUTS

THE RANGE OF CEA7 AND CEM7 CONTROLLERS ALLOW THE MONITORING OF THE DEVICES STATUS BY MEANS OF A NUMBER OF RELAY OUTPUTS.

The Telesignal option is connected to the range of CEM7 devices of Himoinsa through a CAN communication cable. The configuration software of the controlboards, configured in local mode (USB can) or remote (CCRs), allows the adjustment of its functions.

The Telesignal option is connected to the CEM7 Himoinsa controlboard with a twisted pair with or without shielding; depending of the installation environment and it can even be of 1 Km length. The CEM7 device allows the installation of 4 optional Telesignal equipments simultaneously.

15.1. Telesignal components:

- Feeding and communication terminal plate
- Terminal plate of digital outputs to relay
 - 4 contact outputs NC/NA.
 - 8 contact outputs NA
- 1 feeding led
- 12 LEDs to visualize the output status.
- Activation Microswitch, CAN terminator.
- Microswitch of 2 switches to fix the number of modules (maximum 4)

SWITCH		ID
2	1	
-	-	0
-	ON	1
ON	-	2
ON	ON	3

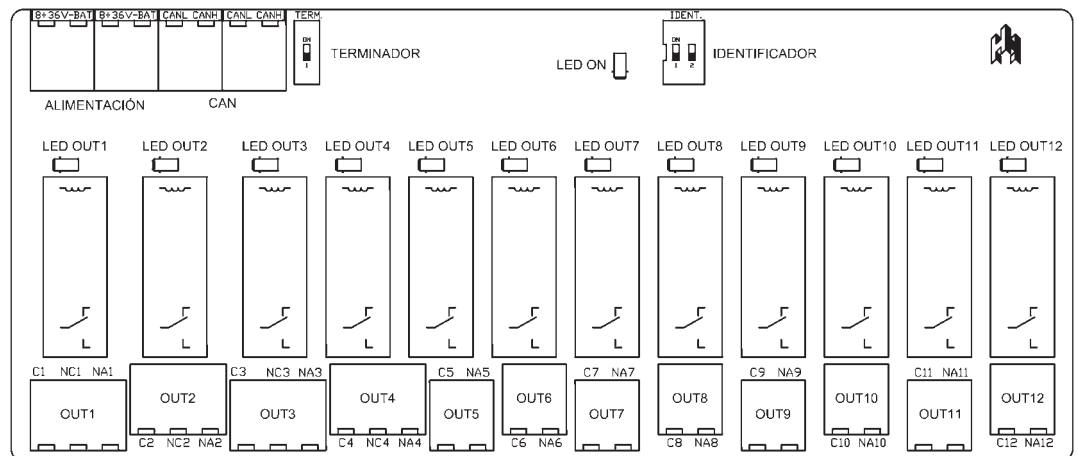

Figure 1. Telesignal module.



15.2. Telesignal programation

The Telesignal option allows the output programation in order to monitor the status of the CEM7 device.

The “Configurator” application is used to programming the Telesignal option. This application only detects and programs the Telesignal with the 0 identification. If 2 or more Telesignal would be necessary in one installation, see the following procedure:

1. Switch off all the Telesignal modules.
2. Switch on the only one Telesignal with the 0 identification. Configure it with the Telesignal application.
3. Switch off the Telesignal module when it is already configured and modify/change the identification (1,2 or 3)

Repeat the process with all the Telesignal modules.

This programation option showed below will be available if the Telesignal option is installed. On the left of the screen, a tree view presents all the activation conditions of each output.

The programation process of an output is the following:

1. Select the item referring the chosen output.
2. Select the file where the activation conditions we want to apply to the selected output can be found
3. Select the desired condition.
4. Repeat the process with all the conditions needed.

By pressing the “General Alarm” button all the possible alarm conditions to activate the output are selected.

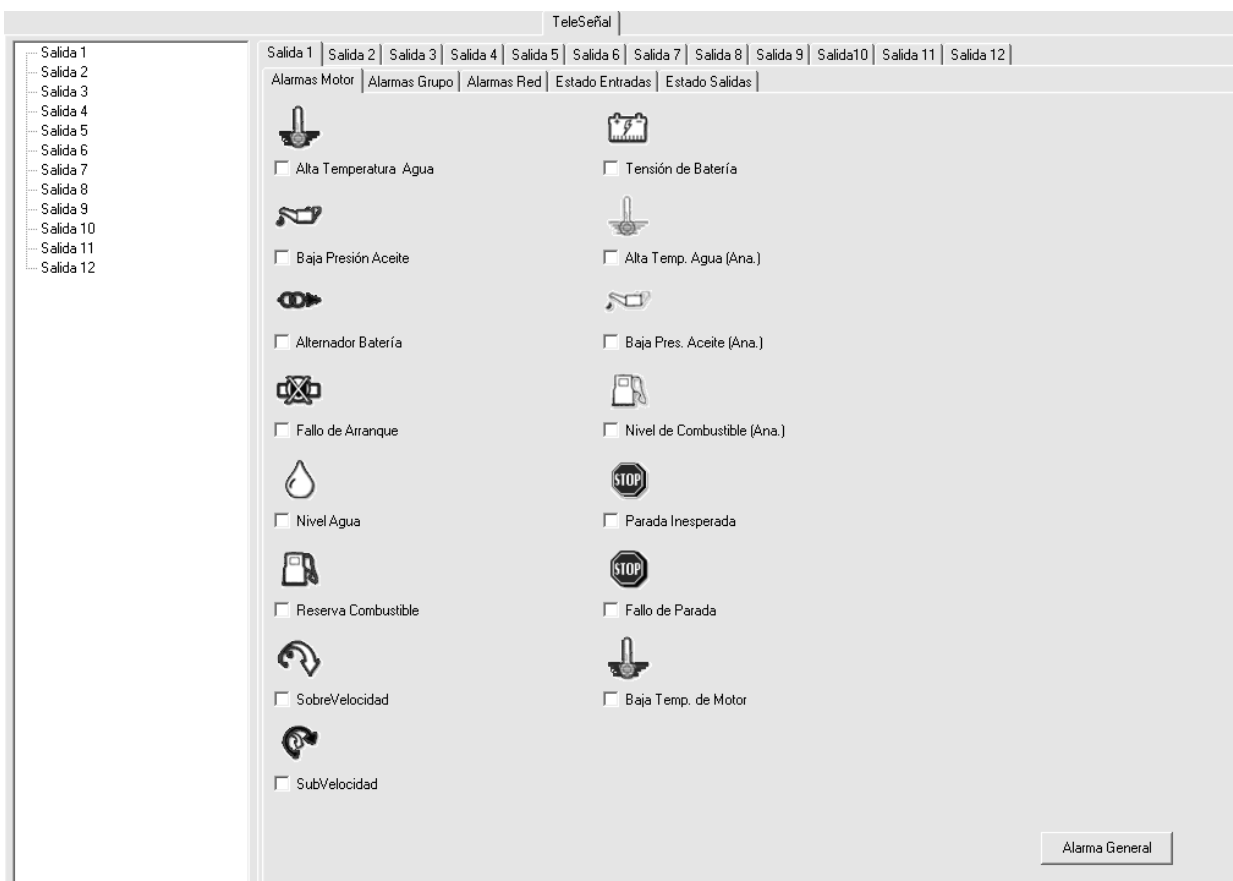

Figure 2. Configuración de la Telesignal.



15.3. Working mode

The outputs of the Telesignal option can be programmed to be activated depending on:

- Any alarms of the controlboard, active or waiting to be checked.
- Any activated input of the controlboard.
- Any activated output of the controlboard.
- Control mode (Automatic or Manual).

Each output of the Telesignal device is activated if, at least, one of the programmed activation conditions is raised.



15.4. Wiring of the Telesignal option

SIGNAL	DESCRIPCIÓN	TYPE	CHARACTERISTICS
8÷36V	Battery positive	Feeding	Controlboard Feeding voltage from 8 to 36V
-BAT	Battery negative	Feeding	Controlboard negative feeding
8÷36V	Battery positive	Feeding	Controlboard Feeding voltage from 8 to 36V
-BAT	Battery negative	Feeding	Controlboard negative feeding
CANL	CANL line CAN bus	Bus	CAN communication
CANH	CANH line CAN bus	Bus	CAN communication
CANL	CANL line CAN bus	Bus	CAN communication
CANH	CANH line CAN bus	Bus	CAN communication
C1	Common relay output 1	Digital output	Voltage free contact 8 A 250 VAC
NC1	Normally-closed contact relay output 1	Digital output	Voltage free contact 8 A 250 VAC
NA1	Normally-open contact relay output 1	Digital output	Voltage free contact 8 A 250 VAC
C2	Common relay output 1	Digital output	Voltage free contact 8 A 250 VAC
NC2	Normally-closed contact relay output 2	Digital output	Voltage free contact 8 A 250 VAC
NA2	Normally-open contact relay output 2	Digital output	Voltage free contact 8 A 250 VAC
C3	Common relay output 2	Digital output	Voltage free contact 8 A 250 VAC
NC3	Normally-closed contact relay output 3	Digital output	Voltage free contact 8 A 250 VAC
NA3	Normally-open contact relay output 3	Digital output	Voltage free contact 8 A 250 VAC
C4	Common relay output 3	Digital output	Voltage free contact 8 A 250 VAC
NC4	Normally-closed contact relay output 4	Digital output	Voltage free contact 8 A 250 VAC
NA4	Normally-open contact relay output 5	Digital output	Voltage free contact 8 A 250 VAC
C5	Common relay output 3	Digital output	Voltage free contact 8 A 250 VAC
NC5	Normally-closed contact relay output 4	Digital output	Voltage free contact 8 A 250 VAC
C6	Common relay output 3	Digital output	Voltage free contact 8 A 250 VAC
NC6	Normally-closed contact relay output 4	Digital output	Voltage free contact 8 A 250 VAC
C7	Common relay output 3	Digital output	Voltage free contact 8 A 250 VAC
NC7	Normally-closed contact relay output 4	Digital output	Voltage free contact 8 A 250 VAC
C8	Common relay output 3	Digital output	Voltage free contact 8 A 250 VAC
NC9	Normally-closed contact relay output 4	Digital output	Voltage free contact 8 A 250 VAC
C9	Common relay output 3	Digital output	Voltage free contact 8 A 250 VAC
NC9	Normally-closed contact relay output 4	Digital output	Voltage free contact 8 A 250 VAC
C10	Common relay output 3	Digital output	Voltage free contact 8 A 250 VAC
NC10	Normally-closed contact relay output 4	Digital output	Voltage free contact 8 A 250 VAC
C11	Common relay output 3	Digital output	Voltage free contact 8 A 250 VAC
NC11	Normally-closed contact relay output 4	Digital output	Voltage free contact 8 A 250 VAC
C12	Common relay output 3	Digital output	Voltage free contact 8 A 250 VAC
NC12	Normally-closed contact relay output 4	Digital output	Voltage free contact 8 A 250 VAC

The CAN network of the controlboard has a BUS based topology. The different devices are consecutively connected, using the CANH and CANL input and output terminals to link the modules.

The terminating resistors will be connected to the network terminal nodes, using the appropriate micro-switch.

The maximum distance between the terminal nodes of the network is 1000 m



15.5. Dimensions and connections

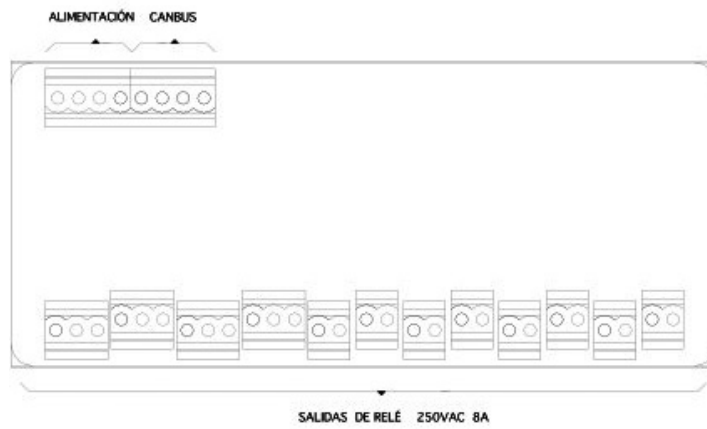

Figure 1. Conexión módulo teleseñal 1

To feed the plates it is advisable to use 1 mm² diameter cable

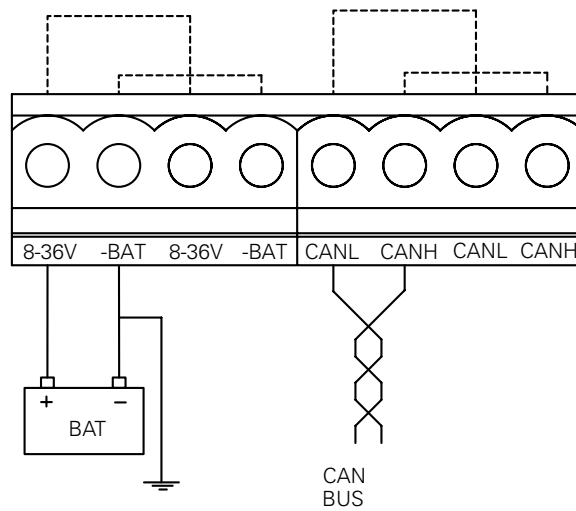

Figure 2. Conexión módulo teleseñal 2

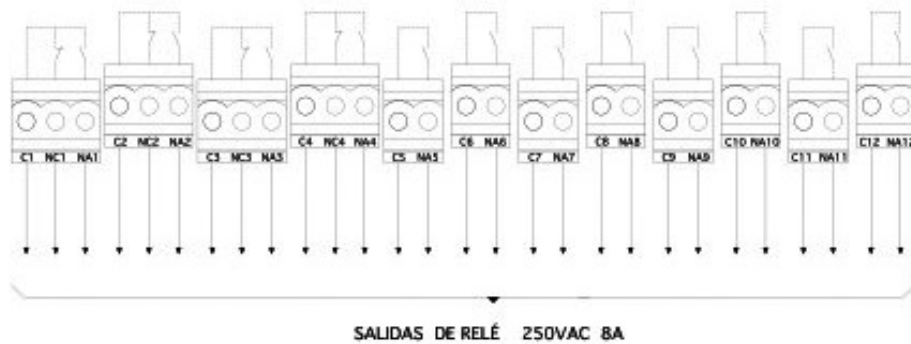

Figure 3. Conexión módulo teleseñal 3



SIGNAL	DESCRIPTION	TYPE	CHARACTERISTICS
8÷36V	Battery positive	Feeding	Controlboard feeding voltage from 8 to 36V
-BAT	Battery negative	Feeding	Feeding controlboard negative
CANL	CANL line CAN bus	Bus	CAN communication
CANH	CANH line CAN bus	Bus	CAN communication
C1	Relay 1	Output	Relay 1, contact C
NC1	Relay 1	Output	Relay 1, contact NC
NA1	Relay 1	Output	Relay 1, contact NA
C2	Relay 2	Output	Relay 2, contact C
NC2	Relay 2	Output	Relay 2, contact NC
NA2	Relay 2	Output	Relay 2, contact NA
C3	Relay 3	Output	Relay 3, contact C
NC3	Relay 3	Output	Relay 3, contact NC
NA3	Relay 3	Output	Relay 3, contact NA
C4	Relay 4	Output	Relay 4, contact C
NC4	Relay 4	Output	Relay 4, contact NC
NA4	Relay 4	Output	Relay 4, contact NA
C5	Relay 5	Output	Relay 5, contact C
NA5	Relay 5	Output	Relay 5, contact NA
C6	Relay 6	Output	Relay 6, contact C
NA6	Relay 6	Output	Relay 6, contact NA
C7	Relay 7	Output	Relay 7, contact C
NA7	Relay 7	Output	Relay 7, contact NA
C8	Relay 8	Output	Relay 8, contact C
NA8	Relay 8	Output	Relay 8, contact NA
C9	Relay 9	Output	Relay 9, contact C
NA9	Relay 9	Output	Relay 9, contact NA
C10	Relay 10	Output	Relay 10, contact C
NA10	Relay 10	Output	Relay 10, contact NA
C11	Relay 11	Output	Relay 11, contact C
NA11	Relay 11	Output	Relay 11, contact NA
C12	Relay 12	Output	Relay 12, contact C
NA12	Relay 12	Output	Relay 12, contact NA



15.6. Electric characteristics

Symbol	Parameter	Conditions	Minimum	Usual	Maximum	Unit
Feeding (terminals 8÷36V, -BAT)						
8÷36V	Power supply voltage of the unit		8		36	VDC
I_{BAT}	Feeding force	8÷36V=12V				mA
I_{BAT}	Feeding force	8÷36V=24V				mA
P_{BAT}	Power consumption					W
CAN Bus (CANL, CANH terminals)						
V_{IN}	CANH y CANL input voltage		-27		+40	V
DR_{CAN}	Transmission speed			50		Kbps
L_{CAN}	Bus length				250	m
Nodes	Number of nodes on the bus				20	nodes
Relay outputs (Terminals C1, NC1, NA1, C2, NC2, NA2, C3, NC3, NA3, C4, NC4, NA4, C5, NA5, C6, NA6, C7, NA7, C8, NA8, C9, NA9, C10, NA10, C11, NA11, C12, NA12)						
V_o	Relay contactors maximum voltage				250	VAC
I_o	Relay contactors power	$\cos\varphi = 0$			8	A

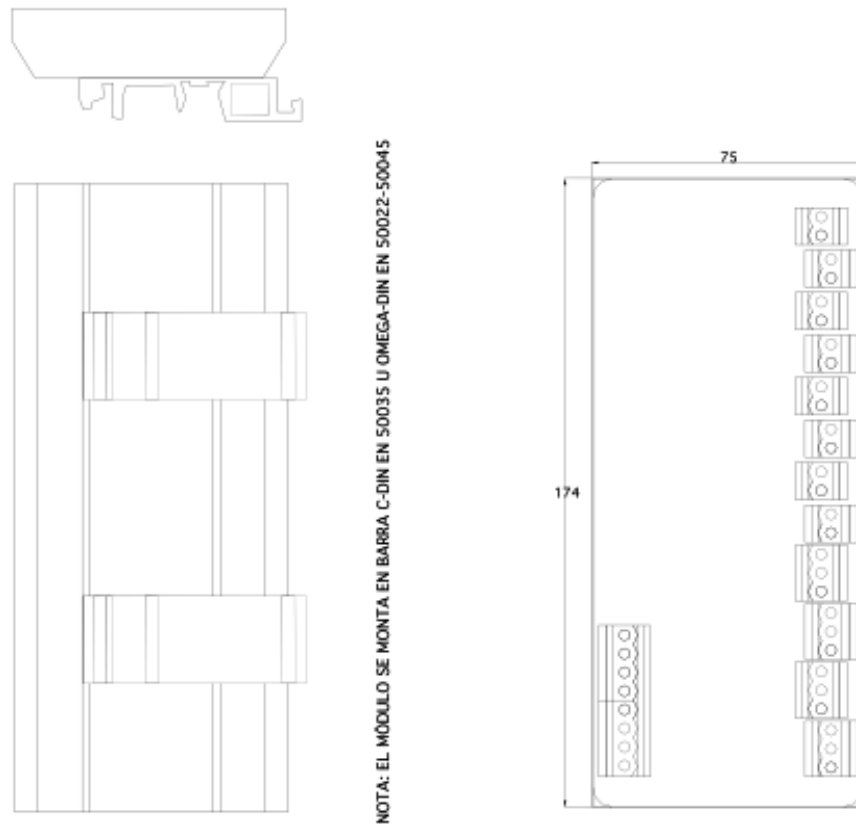

Figure 4. Dimensiones módulo teleseñal



16. (ANNEX VIII) CCrs: COMMUNICATION OPTION VIA MODEM

THE RANGE OF CEA7 AND CEM7 CONTROLLERS ALLOW A REMOTE MONITORING AND SUPERVISION FUNCTION THANKS TO THE CCrs OPTION.

This option allows to establish a connection between the controlboard and the monitorization and configuration software, by means of a modem or GPRS .

16.1. CCrs installation

16.1.a. System requirements.

The CCrs option needs the following elements to obtain a remote connection:

- PC that fulfils the following requirements to execute the monitorization and configuration software:
- Pentium III 1.3 GHz
- Microsoft Windows XP with Microsoft Net Framework 2.0
- 512 Mb RAM
- 50 Mb free in the hard disk
- Modem 14400 or superior (line modem or GPRS).
- Modem and serial cable to connect to the CCrs
- Optional: a null modem type cable and CCrs configuration software.

16.1.b. Communicating with the controlboard.

The Pc software of the controlboard automatically detects (when starting) if a local connection of communications (USB Can option) is available or if it is detected a remote connection via modem. In case a remote connection is found, a dialog box will appear waiting to enter the required parameters to establish the communication.



Figure 1. Parameter box of remote communication

Communication parameters required:

- Telephone number of the controlboard.
- PIN: Pin of the SIM if required
- Password: Controlboard password, at least user level password.
- Kind of modem: Line or GSM/GPRS.
- Locate option.

The introduced parameters can be stored for the next use (except the controlboard password)

In the same way, a kind of “waiting connection” can be done, capable of allowing the connection between the controlboards and the PC software in case any event occurs in the registration moment.

Once the dialing data are introduced, the software of the PC tries to establish the connection with the controlboard.

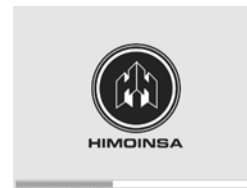

Figure 2. Connection with the controlboard screen

As soon as the connection with the controlboard is confirmed, the monitorization or configuration software of the controlboard starts running.

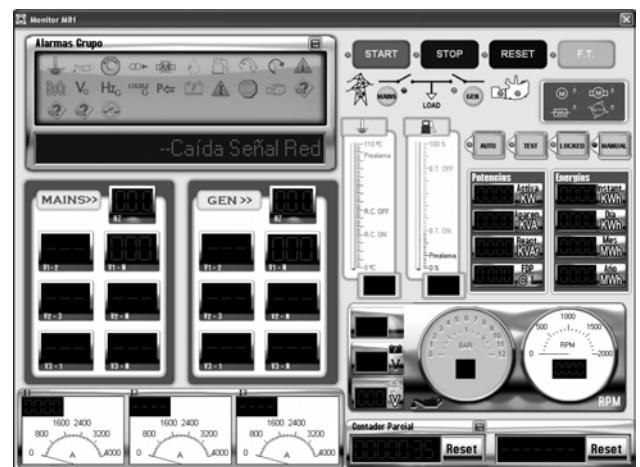

Figure 3. Monitorization controlboard software



FILIALES_ SUBSIDIARIES

EUROPA / EUROPE

HIMOINSA FRANCE (GENELEC S.A.S.)
TLF. +33 474 62 65 05 FAX: +33 474 09 07 28

HIMOINSA ITALIA S.R.L.
TLF. +39 0444 58 09 22 FAX: +39 0444 183 33 08

HIMOINSA PORTUGAL LDA
TLF. +351 21 426 65 50 FAX: +351 21 426 65 69

HIMOINSA POLSKA SPZO.O
TLF. +48 22 868 19 18 FAX: +48 22 868 19 31

HIMOINSA DEUTSCHLAND GmbH
TLF.+ 49 160 5449457

ASIA - PACÍFICO / PACIFIC - ASIA

HIMOINSA CHINA CO. LTD
TLF. +86 519 8622 66 88 FAX:
+86 519 86 22 66 87

HIMOINSA FAR EAST PTE LTD
TLF. +65 6 265 10 11 FAX: +65 6 265 11 41

ORIENTE MEDIO / MIDDLE EAST

HIMOINSA MIDDLE EAST FZE
TLF. +971 4 887 33 15 FAX: +971 4 887 33 18

AMERICA

HIMOINSA MEXICO
TLF. +52 (33) 3675 86 46 FAX:
+52 (33) 3914 25 90

HIMOINSA POWER SYSTEMS, INC. (USA)
TLF. +1 913 495 55 57 FAX: +1 913 495 55 75

HIMOINSA PTY (PANAMA)
TLF. +507 232 57 41 FAX: +507 232 6

HIMOINSA LATINOAMERICA (Rep. Argentina)
TLF. + 54 2320 401900 / 1901

HIMOINSA CENTRAL_ HEAD OFFICE

HIMOINSA S.L
Ctra. Murcia - San Javier, km 23.6
30730 San Javier (MURCIA) SPAIN
TLF. +34 968 19 11 28 / +34 902 19 11 28
FAX +34 968 19 12 17
EXPORT FAX +34 968 19 04
20 /+34 968 33 43 03
info@himoinsa.com www.himoinsa.com

HIMOINSA CENTRO (Madrid)
TLF. +34 91 684 21 06
FAX +34 91 684 21 07

Centro de Distribución Recambios
Spare Parts Distribution Centre
TLF. +34 968 33 40 15
FAX +34 968 19 11 53