

AW-DC1700WM
AW-DC1500WM
AW-DC1300WM
AW-DC1700WSE
AW-DC1500WSE
AW-DC1300WSE

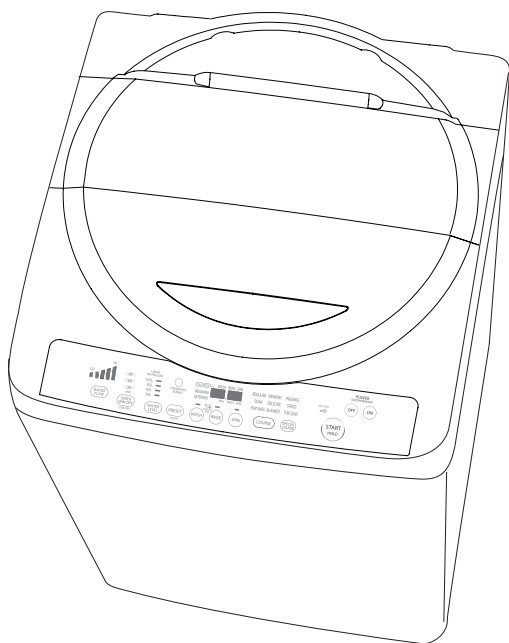

CONTENTS

WARNING 2

CAUTION 3

DESCRIPTION OF PARTS 3

CONTROL PANEL

 DESCRIPTION 4~5

OPERATION OF FULLY AUTOMATIC WASHING MACHINE 6~7

HOW TO OPERATE 8

AUTOMATIC WASHING 9

WATER FLOW POWER 10

WASHING COURSE 11~16

CUSTOM WASH CYCLES 17~18

SUPER SPIN DRY 19~20

CHILD PROOF MODE 21

PRESET MODE 21

OPTION MODE 22~23

RESUME FUNCTION 23

LID LOCK 23

RECOMMENDED DETERGENT

 AMOUNT 24

LAUNDRY GUIDE 25

INSTALLATION 26~28

MAINTENANCE 29~31

BEFORE CALLING THE

 SERVICEMAN 32~35

HANDLING METHOD FOR

















 EMERGENCY 35

SPECIFICATIONS 35

Thank you for purchasing TOSHIBA Fully Automatic Washing Machine.
Please read this manual carefully in order to operate the machine properly and safety.
Please keep this manual for future reference.









6348223301

⚠ WARNING

<p>⚠ WARNING: This indicates an important item which incorrect operation may lead to injury or death.</p>	
 DO NOT TOUCH	<ul style="list-style-type: none"> Never attempt to touch laundry in the spin basket until the motion of the basket stops completely. Laundry in the basket may become wrapped around the hand, even when the basket is only moving slowly. Use particular caution when children are present. 
 OUT OF CHILD	<ul style="list-style-type: none"> Never operate washing machine by young children and infirm person. This washing machine is not intended for use by persons (including children) with reduced physical, sensory or mental capabilities, or lack of experience and knowledge unless they have been adequately supervised by a responsible person to ensure that they can use the washing machine safely. Children should be supervised to ensure that they do not play with the washing machine. Never allow children to look into the basket or play around the washing machine. Do not place the stand or box near the washing machine. Children may fall into the basket and get injured or drowned. 
 DO NOT MODIFY	<ul style="list-style-type: none"> Never disassemble or modify the machine. It may cause fire or electrical shock or malfunctions that lead to injuries. Consult the store you bought the machine.
 ELECTRIC SHOCK	<ul style="list-style-type: none"> Use proper power source indicated in the rating label of the machine. It may cause fire or electrical shock. Failure to use a proper power source may result in the electrical outlet becoming excessively hot, leading to fire.
 UNPLUG POWER	<ul style="list-style-type: none"> Unplug the power cord from the electrical outlet before attempting to cleaning or maintenance the washing machine.
 DO NOT WET HAND	<ul style="list-style-type: none"> Do not insert or pull the power plug with wet hands. It may cause electrical shock or malfunctions that lead to injuries.
 ELECTRIC SHOCK	<ul style="list-style-type: none"> Never use damaged electrical cords or plugs or loose socket. It may cause electrical shock or malfunctions that lead to injuries or fire.
 DO NOT DISASSEMBLE AND REPAIR	<ul style="list-style-type: none"> Do not damage the power cord. Do not attempt to damage, cut, or modify the power cord, or subject it to excessive bending, pulling, twisting, or binding. Also, do not yank the metal portion, place heavy objects on the power cord, or pinch the power cord. Doing so may damage the power cord, resulting in fire or electrical shock. If the power cord is damaged, it must be replaced by the manufacturer or its service agent or a similarly qualified person in order to avoid a hazard.
 DO NOT USE WET PLACE	<ul style="list-style-type: none"> Do not install the washing machine in highly humid place. Do not install in a bathroom or in exposed area to the rain. Doing so may result in electrical shock or short circuit.
 DO NOT SPLASH WATER	<ul style="list-style-type: none"> Do not allow water to come into direct contact with the various parts of the outer body. Doing so may result in electrical shock or short circuit.
 AVOID INFLAMMABLE	<ul style="list-style-type: none"> Do not place flammable materials in the basket. Do not put any kerosene, gasoline, benzene, thinners, alcohol, other flammable materials, or the laundry soaked with such materials in the basket. It can cause explosion or fire.
 REMOVE DUST	<ul style="list-style-type: none"> Wipe away off the dust or grime which attached to surface on pin of the plug. The dust or grime may cause fire.
 AVOID INFLAMMABLE	<ul style="list-style-type: none"> Do not place a fire source such as a candle or cigarette near the washing machine. It may cause fire.
 INSTALL CAREFULLY	<ul style="list-style-type: none"> Make sure that water drains properly. Using the washing machine with faulty drainage may cause water to back up within the machine, leading to electrical shock or fire.

! CAUTION

! CAUTION: This indicates an important item which incorrect operation may lead to injury or damages to the product.

 DO NOT PULL	<p>■ Do not pull the power cord when unplug the appliance. Hold the plug body to unplug. It may cause electrical shock or malfunctions that lead to injuries.</p>
 DO NOT USE	<p>■ Do not connect to the hot water supply. ■ Do not use water with temperatures over 50°C. Water that is too hot may cause malfunctions and deformation of the machine, which may result in electrical shock.</p>
 DO NOT WASH	<p>■ Do not wash or spin extraction the mats, waterproof suites such as raincoats, fishing suite (jackets and pants) ski suite, sleeping bags etc. It will cause abnormal vibration and damage while in spin extracting.</p>
 DO NOT CLIMB	<p>■ Do not climb or place heavy objects on the washing machine. Doing so may result in injury due to bending or breakage.</p>
 UNPLUG POWER	<p>■ Pull out the plug if you do not plan to use the machine for a long time. Failure to do so may result in electrical shock or shorts due to deterioration of the insulation.</p>
 DANGER HAND	<p>■ Do not place the hands or other objects under the washing machine while in operation. Moving parts may cause injury.</p>
 WATER LEAKAGE	<p>■ Before use, make sure the faucet is open, and the connection with water inlet hose is not loose or leakage water. Looseness of hose nut, hose connections, water inlet valve or other areas may cause water leakage or other damage.</p>
 INSTALL CAREFULLY	<p>■ The bottom ventilation of washing machine must not be obstructed by carpet when the washing machine is installed on a carpet floor.</p>
 STOP OPERATED	<p>■ During the spin extracting, if the spin basket does not stop rotation completely within 15 seconds after the lid is opened. Please stop operating the washing machine immediately and contact to service dealer for repairs.</p>

DESCRIPTION OF PARTS

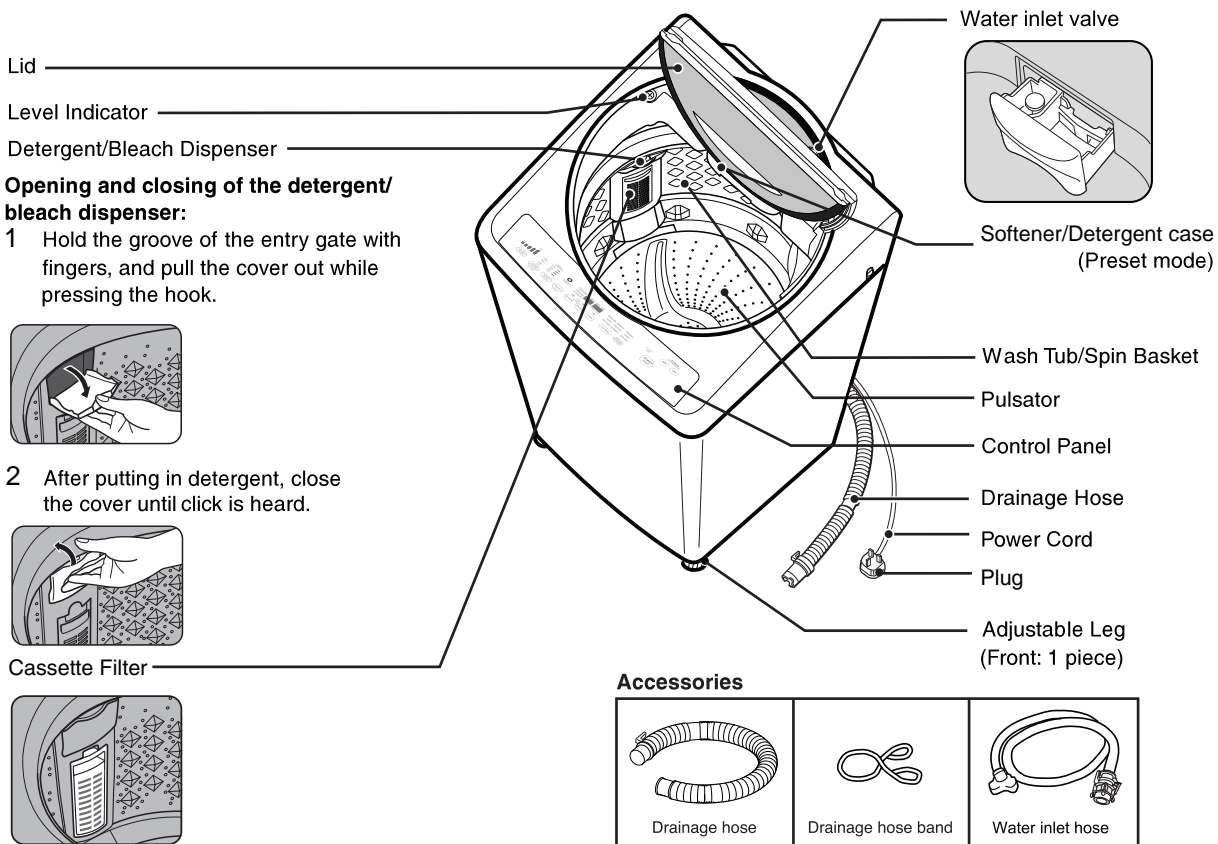

CONTROL PANEL DESCRIPTION

Control Panel of AW-DC1700W series , AW-DC1500W series and AW-DC1300W series.

- Following is the operation panel of AW-DC1700W series.
- Apart from the displaying values of [WATER LEVEL], other items are common to AW-DC1700W series.

Display section

- The currently-running course is displayed blinking and the remaining courses are lighted stably.

(ex.) When WASH course is in operation



- When power is switched on and a course is selected

Time for washing and spinning as well as times for rinsing are displayed.

(ex.) WASH = 15 MIN.
RINSE = 2 TIMES
SPIN = 5 MIN.



- After press **START HOLD** button,

the detergent amount is displayed.

(ex.) Indicating 1.9 cup



- ※ The amount for 1 measuring scoop (cup) of detergent differs according to specific type of detergent. Please increase or decrease the amount of detergent according to the detergent used and reference water level displayed.

“SUPER SPIN DRY” button

- Timing drying operates based on selected time period. As soon as the button is pushed, the indicator will be on until the selected time period ends.
- Indicator goes out according to the remaining operating time.

“CONDENSED BUBBLE” Indicator

- The indicator will be on after “CONDENSED BUBBLE” is selected, and keep blinking during operation.

“CHILD PROOF” Indicator

- After selecting child proof mode, “●” will light up.

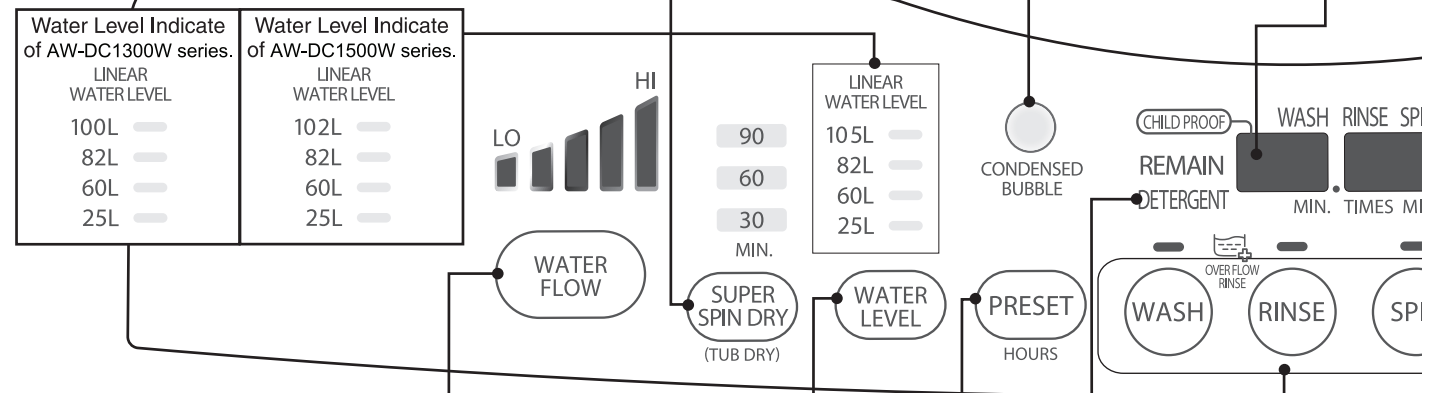

“WATER FLOW” Button

- Press the “WATER FLOW” to choose the water flow power.
- Selection can be made only when any of “REGULAR”, and “MEMORY” is selected.

“WATER LEVEL” Button

- The water level indicator will light up when the water is at the set level.

Automatic Mode

- The water level is set linearly by adjusting to the washing volume. If the water level is assigned at the point with no particular indication, then the nearest level will light up.
- If there is some water in the basket before the operation, the indicator at the highest level will light up.

Setting the **WATER LEVEL** button

- Press the **WATER LEVEL** button to choose the water level. The indicator at the water level will light up.
- While the water is flowing into the basket, the indicator at “WATER LEVEL” will blinking.

“DETERGENT” Indicator

- When this indicator light up, digital display show recommended detergent amount.

“PRESET” Button

- You can preset the time of all washing process.

“WASH” “RINSE” “SPIN” Buttons

- The indicator will keep blinking during operation and lighting according to the remaining operating time.
- When the machine is powered on and the washing process is preset, time periods for washing, rinsing and spinning will be displayed.

- The amount of supply using the measure spoon accompanying the compact detergent is displayed.



One measuring scoop of detergent for the water: 55 liters

- **After the start of operation**
If the lid is closed, the estimated residual time to the end of washing will be displayed.
- **Reservation of the time to complete washing**
The preset time are displayed.
- **If an error occurs.**
An error code will be displayed.

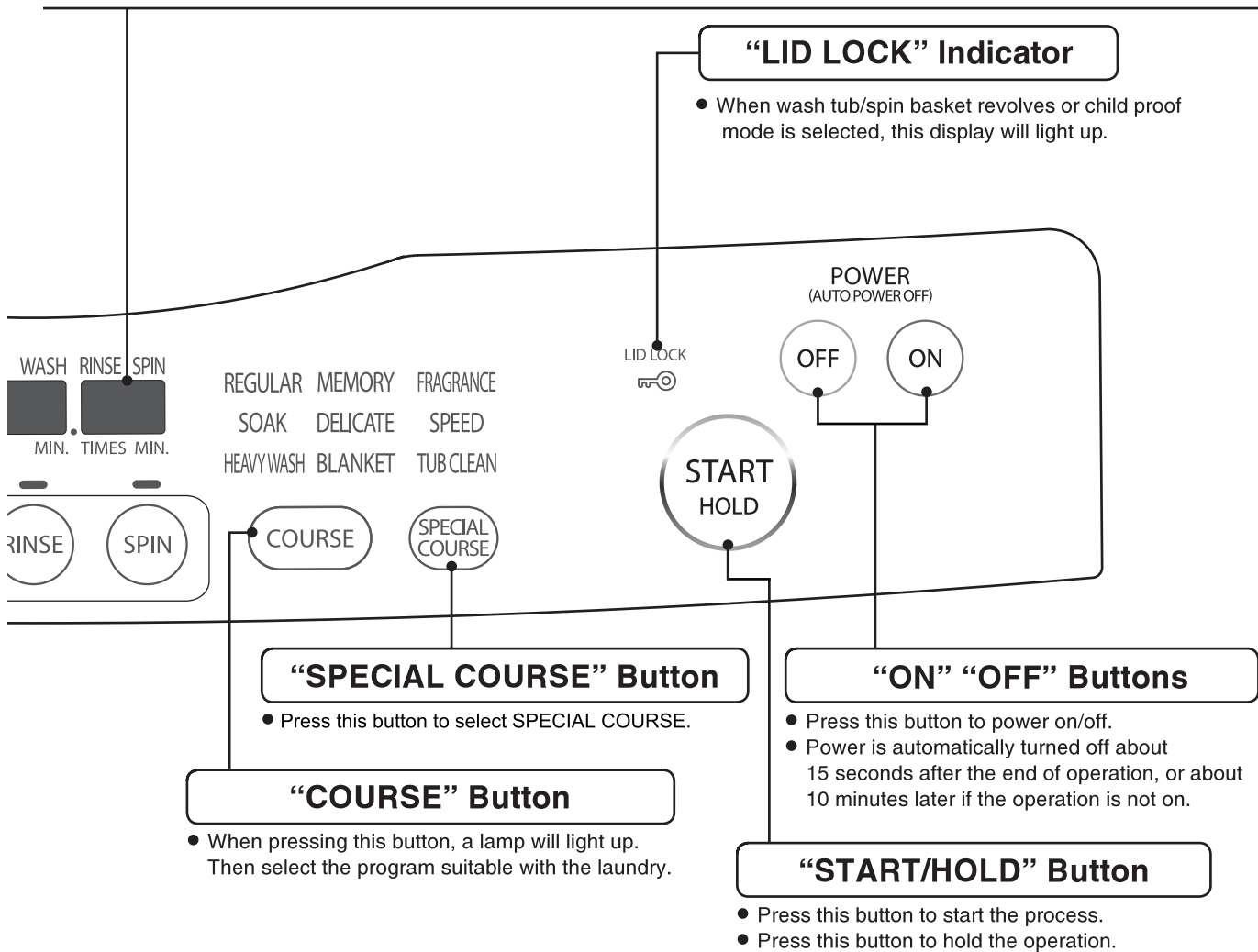
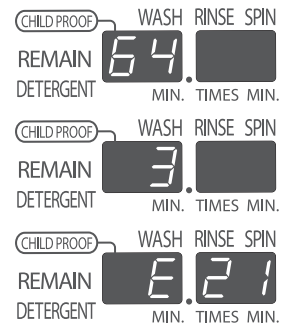

OPERATION OF FULLY AUTOMATIC WASHING MACHINE

Fully automatic washing machine will operated to the following.

This section describes the procedure of the “REGULAR” course with “CONDENSED BUBBLE”.

Put the laundry in the basket and start the machine. The sensor will weigh clothes and begin flowing water.

1 The pulsator begins to revolve 6 seconds after startup under none-water situation, and clothes are weighed.

- After the start of operation If the lid is opened an error code will be displayed.



2 Detergent amount is displayed. Put in detergent to Detergent / Bleach dispenser , and softener to softener case.

Close the lid.

- Reference value of detergent amount.



3 Flowing water starts while the lid will be locked auto-matically

- When a chemical fiber, blending fiber or spreadsheet is washed, the water level may be a little bit low. Adjust the water level by  button.

Washing

CONDENSED BUBBLE

**The 1st rinsing.
(Shower rinse)**

Stirring during flowing water



Stirring after flowing water



Stirring after flowing water



Spinning after draining



Shower rinsing
Flowing water starts while the spin basket revolves slowly.



1 time for

Stirring starts during flowing water while washing and flowing water are executed simultaneously.

Times of flowing water differ depending on clothes weight and rinsing frequency.

Why does the washing time appear a little bit long? Is the time displayed changed?

About the display of the remaining time

The display is based on the flowing water amount of 15 liters/minute.

Under the following situations, washing time may be longer than remaining time displayed, or the time displayed may be changed during the process.

- Flowing water amount is smaller than 15 liters/minute.
- Unsmooth water draining.
- Gravity center of clothes shifts.

What is overflow rinsing?

During stirring, flowing water and rinsing are executed simultaneously.



When flowing water amount is small, the wash tub/spin basket may not be filled up.

■ Washing process can be changed while the clothes are washed.

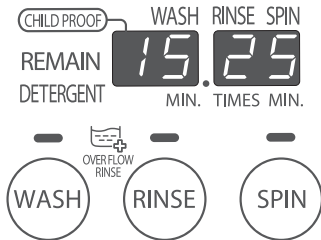

1 Press button to hold the operation.

2 Press the button of mode you want to change.

- “No-washing”, “No-rinsing” and “No-spinning” cannot be set.
- When “Super Spin Dry” is set, the spinning setting can not be changed.

3 Press button again to start the operation.

- Changeable items are same as the custom setting.

Rinsing

Spinning

Super Spin Dry

The 2nd rinsing
(Static rinse)

Lid Lock

Spinning after
draining

Soaking and washing
Water is flowed to the
setting level.

Stirring

Spinning after
draining

**Set the Super Spin
Dry according to
your needs.**



this process



Softener automatically added during final rinsing.



What happen if flow the water during spinning?

About the gravity center of the clothes

When the gravity center of the clothes shifts during spinning, the remaining time will become longer if the following course is appended.



Stop spinning when
the gravity center
shifting is detected



flow water and
correct the shifting



Redo draining
and spinning process

HOW TO OPERATE

Preparation

- 1 Set the drainage hose for draining
(Refer to page 27)

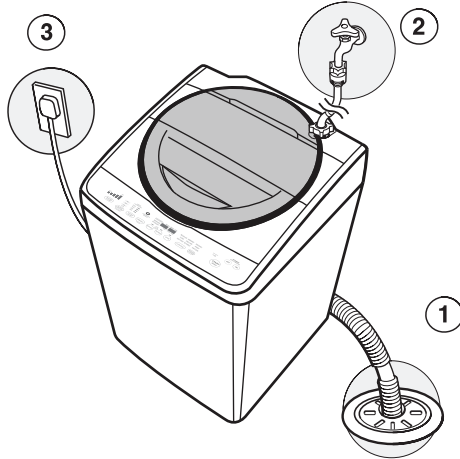

- 2 Set the water inlet hose correctly.
(Refer to page 28)

Turn the water faucet on

- Make sure that there are no sign of water leakage at water faucet and water inlet valve.

- 3 Connect the power plug.

Tips

Make sure to attach the cassette filter before running. Otherwise the water may splash seriously and clothes are subject to damage because of being hooked by the mounting parts.

- Method of putting in clothes
- Put in larger clothes or buoyant ones first.

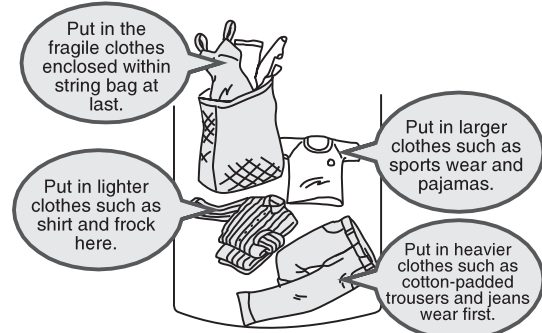

Buoyant clothes such as

- 100% chemical fiber material, like overall.
- 100% chemical fiber or blending fiber material, like flannelette.
(Chemical fiber means polyester fiber, acrylic emulsion or nylon fiber.)

Even articles labeled as washable by washing machine, such as pillow, cushion and buffer, can not be washed by this type of machine, because they can not be sufficiently immersed with detergent even press them after flowing water. Furthermore, clothes may fly out of the wash tub/spin basket or failure will occur during spinning.

- Clothes need to be put in as evenly as possible and fully pressed into the wash tub/spin basket.

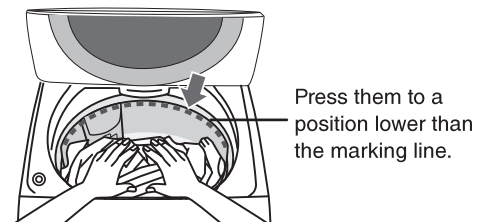

- Baggy clothes which are subject to deform need to be washed separately.
- Adding clothes during washing

Please press  button and add more clothes after the machine fully stops. Press the clothes from above to make them soaked with the detergent.

AUTOMATIC WASHING

Normal clothes can be washed through the optimum courses from washing to spinning.

REGULAR course for normal clothes

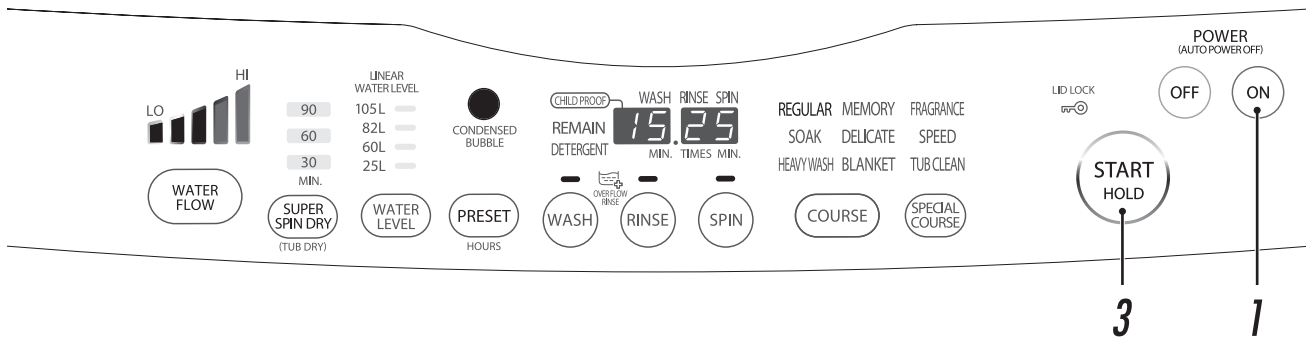

What is the CONDENSED BUBBLE?

Stirring starts at a low water level. Make detergent froth to have clothes soaked. Flowing water and washing go on simultaneously. Being soaked with concentrate detergent, clothes can be cleaned thoroughly.

(Please add the detergent through the “Detergent / bleach dispenser” inside of the wash tub/spin basket. Failing to do so will reduce the cleaning performance.)





■ Adding detergent

According to the display of detergent amount, add the detergent to the “Detergent / bleach dispenser” inside of the wash tub/spin basket.

- Please press the  button before adding the detergent through the detergent / bleach dispenser.
- Besides, please add the detergent directly around the wash tub/spin basket if the clothes are below 1.5 kg. Too much detergent will cause excessive foam, resulting in lower cleaning performance.

When the clothes are below 1.5 kg, please add detergent directly around the wash tub/spin basket.



- 1 Turn the POWER .**
 - The indicators of “REGULAR” and “CONDENSED BUBBLE” will be lighted.
 - ▶ Please select the    buttons according to your needs.

- 2 Put the laundry in the wash tub/spin basket.**

- 3 Press the  button.**

- The pulsator start to revolve before flowing water, then the machine will weigh clothes and display detergent amount (reference value). (When the lid is opened.)

- 4 Based on the detergent amount displayed, add detergent to the detergent/bleach dispenser, and then close the lid.**

- If you forget to close the lid, [E21] error occurs in 1 minute.

At the end of operation









A “beep” sound will be heard indicating that the course is over.

- Close the faucet and clean the cassette filter.

WATER FLOW POWER

Press  button to choose the water flow power according to your needs such as what to be washed or dirtiness level.

How to choose the water flow power

Key operation	Display	Situation
Turn on the power.		Standard water flow (Default)
Press the  button once.		When you need to wash rather strongly.
Press the  button twice.		When you need to wash strongly.
Press the  button three times.		When you need to wash softly.
Press the  button four times.		When you need to wash rather softly.

- The water flow power during rinsing cannot be changed.
- The water flow power can be adjusted only any of "REGULAR" and "MEMORY" is selected.
- Fragile clothes should not be washed by strong water flow power.
- When the "MEMORY" mode is set, the operation will start with the water flow power preset.
- When the water level reaches to a designated level, the water flow power will be indicated. Such indication will be repeated in the following order. This means the operation is being done under the water flow power preset.

Example (Standard water flow power)

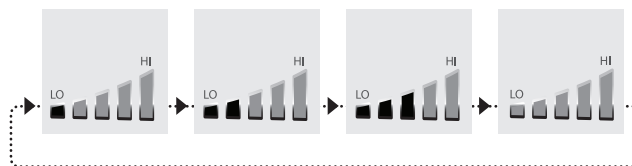

■ When you need to change the water flow power during operation

1 Press the button to hold the operation.

- When you need to wash sensitive clothes softly, hold the operation. Otherwise, such clothes may be damaged.

2 Press the button to choose the water flow power.

- The water flow power will be gradually increased, and then be decreased.

3 Press the button again to start the operation.

- The machine has several water flows level, and execute them step by step. So Even if you set strong water flow, there may be changed to soft water flow.

SOAK course

When washing the seriously dirty clothes and expecting to prevent them from turning yellow.

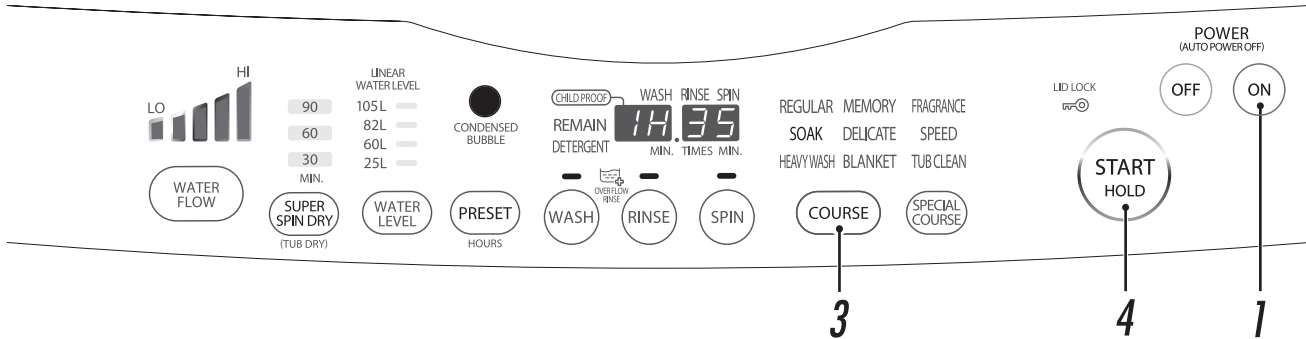

This method is used to wash clothing which easily absorbs stain and clothes with noticeable stains such as underwear and shirt as well as seriously dirty overall, gym suit and thick socks.

Soak and wash them with highly condensed detergent.

■ Implement the Soak Course according to the following instructions.

Pre-washing of the “CONDENSED BUBBLE”



First, have the clothes soaked with the detergent.

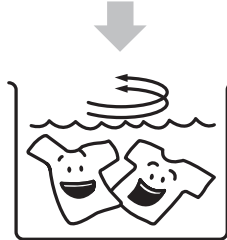

Soak and stir the clothes repeatedly with highly condensed detergent to remove sebum smear.

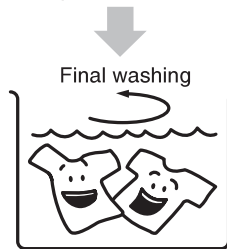

Make the smear easily removable by soaking and washing, thus achieve further cleaning.

- To prevent the clothes from turning yellow, use this course once a month to ensure the optimum performance.
- Press the **WASH** buttons and set the soaking time as 30 mins, 1 hour, 2 hours, 4 hours, 6 hours or 8 hours, depending on your preference.
- Since the washing time is quite long, please do not use this course for clothes of fragile chemical fiber or unstable color.

1 Turn the **POWER** **ON**.

2 Put the laundry in the wash tub/spin basket.

3 Press the **COURSE** button then select “SOAK”.

- ▶ Select the **PRESET** **SUPER SPIN DRY** buttons according to your needs.

4 Press the **START HOLD** button.

- The pulsator starts to revolve before flowing water, and the machine will weigh clothes before displaying detergent amount (reference value). (When the lid is opened.)

5 Based on the detergent amount displayed, add detergent to the detergent/bleach dispenser, and then close the lid.

- If you forget to close the lid, [E21] error occurs in 1 minute.

At the end of operation

A “beep” sound will be heard indicating that the course is over.

- Close the faucet and clean the cassette filter.

HEAVY WASH course When you force to clean clothes thoroughly

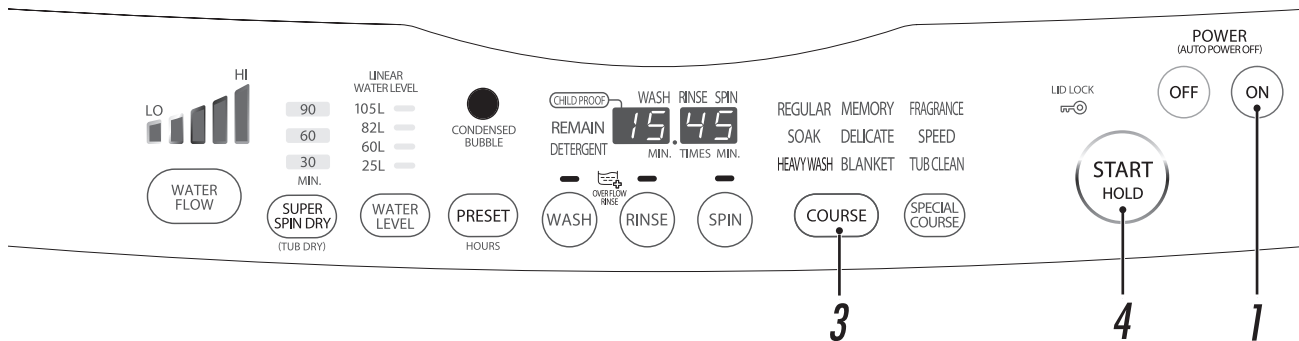

This course is for seriously dirty clothes such as overall, gym suit and thick socks. Compared to the REGULAR course of the “CONDENSED BUBBLE”, this is a course with stronger water flow and more complete rinsing.

- Please do not use this course for fragile clothes such as towel and chemical fiber.
- The rinsing frequency is 4 times of flowing water (2 times for shower rinse and 2 times for overflow rinse.)

1 Turn the POWER .

2 Put the laundry in the wash tub/spin basket.

3 Press the  button then select “HEAVY WASH”.
▶ Select the   buttons according to your needs.

4 Press the  button.

- The pulsator starts to revolve before flowing water, and the machine will weigh clothes before displaying detergent amount (reference value). (When the lid is opened.)

5 Based on the detergent amount displayed, add detergent to the detergent/bleach dispenser, and then close the lid.

- If you forget to close the lid, [E21] error occurs in 1 minute.

At the end of operation

A “beep” sound will be heard indicating that the course is over.

- Close the faucet and clean the cassette filter.

DELICATE course

When you need to wash the clothes softly

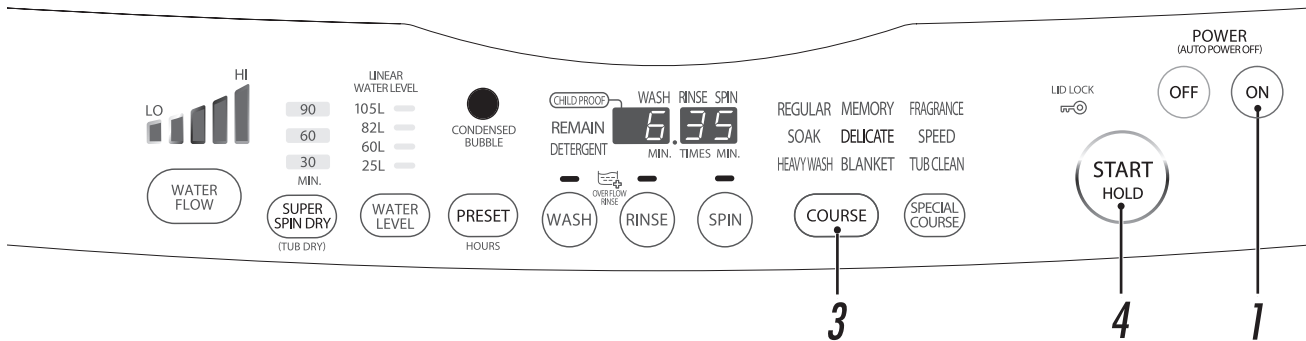

This course is for delicate clothes such as blouse or lingerie to wash gently with very mild water flow.

1 Turn the **POWER** .

2 Put the laundry in the wash tub/spin basket.

3 Press the  button then select “DELICATE”.

► Select the   buttons according to your needs.

4 Press the  button.

- The pulsator starts to revolve before flowing water, and the machine will weigh clothes before displaying detergent amount (reference value). (When the lid is opened.)

5 Based on the detergent amount displayed, add detergent to the detergent/bleach dispenser, and then close the lid.

- If you forget to close the lid, [E21] error occurs in 1 minute.

At the end of operation

A “beep” sound will be heard indicating that the course is over.

- Close the faucet and clean the cassette filter.

BLANKET course

When you need to wash a larger article like a blanket flannelette spread, quilt, curtain and bed sheet.

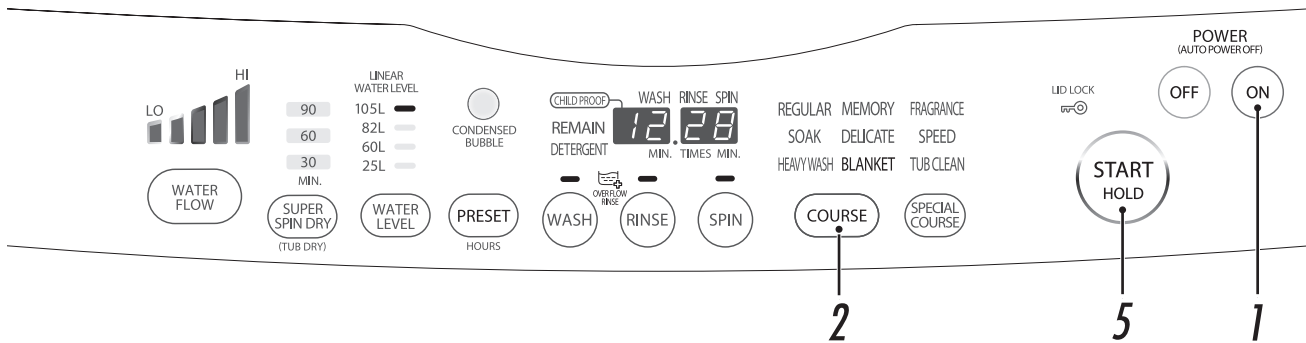

Type and amount which may be washed.

100% synthetic fiber

Type: Mayer, Tuft, Down cloth

Weight: 4.7 kg or less

- All wool blankets and regular electric blankets should NEVER be washed.
Washable electric blankets should be washed according to the washing instruction given in the owner's manual that accompany them when purchased.
- If the blanket will not go into washing net because of fiber length of thickness, it can not be washed.

Folding blankets

- Remove waste or thread from blanket.
- Fold the blanket as pic as below.

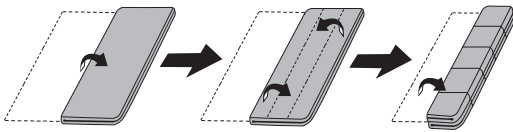

Insert a blanket to the net

- Place the blanket into the blanket net hem-side first, and close the fastener.



Washing period may become longer with drainage condition.

1 Turn the **POWER** **ON** .

2 Press the **COURSE** button, then select the **"BLANKET"**.

- ▶ Select **PRESET** button according to your needs.

3 Based on the water level display, add detergent or softener agent to the detergent/bleach dispenser, and then close the lid.

- The detergent amount is not displayed.

4 Put the larger item blanket washing net enclosed within into the wash tub/spin basket.

5 Close the lid and press the **START HOLD** button.

- When operating with the lid opened, the machine will stop before rinsing or spinning.

At the end of operation

A "beep" sound will be heard indicating that the course is over.

- Close the faucet and clean the cassette filter.

FRAGRANCE course

This course is to maximize the effect of softener, which results in perfumed feeling.

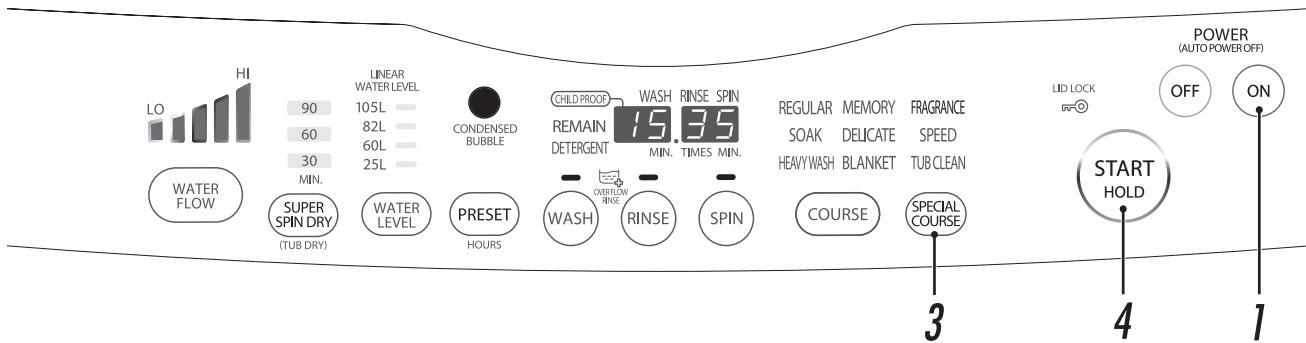

The method would be almost same as “REGULAR” course.

- SOFTENER MUST BE USED. (Refer to page 24,25)

Washing (CONDENSED BUBBLE)

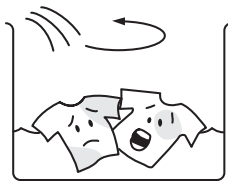

The washing procedure is same as that of REGULAR course.

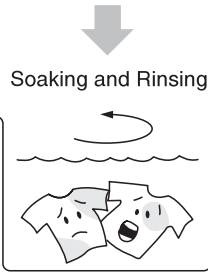

Wash clothes completely by soaking and rinsing.

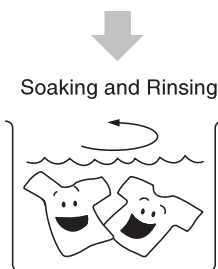

Softener automatically added and wait for a while, having the clothes be soaked with the softening agent.

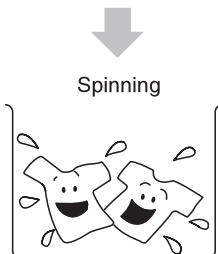

The spinning procedure is same as that of the REGULAR course.

1 Turn the **POWER** .

2 Put the laundry in the wash tub/spin basket.

3 Press the button then select the “FRAGRANCE”

- Select the buttons according to your needs.

4 Press the button.

- The pulsator starts to revolve before flowing water, and the machine will weigh clothes before displaying detergent amount (reference value). (When the lid is opened.)

5 Based on the detergent amount displayed, add detergent to the detergent/bleach dispenser, and then close the lid.

- If you forget to close the lid, [E21] error occurs in 1 minute.

At the end of operation

A “beep” sound will be heard indicating that the course is over.

- Close the faucet and clean the cassette filter.

SPEED course

When you need to wash for light soiled clothes such as shirts.

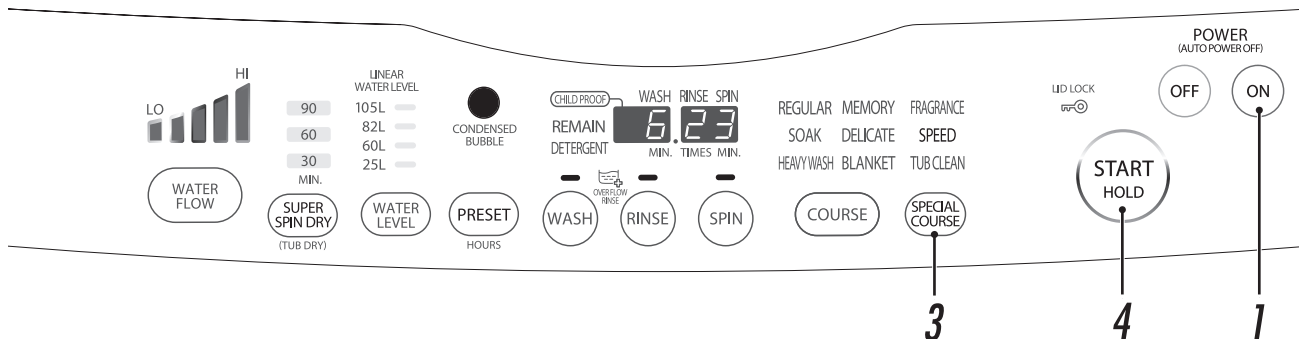

This course is for light soiled clothes. Compared to the “REGULAR” course with “CONDENSED BUBBLE”, this is a course shorter washing and spinning time.

Washing (Condensed bubble washing)



The washing time is shorter than the “REGULAR” course.

Rinsing



Spinning

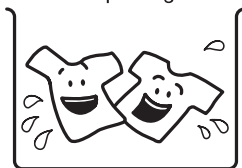

The spinning time is shorter than the “REGULAR” course.

Tips

- Due to shorter spinning time, please do not use this course for towel or other thick clothes.
- Cold air drying and continuous revolving can not be executed.

■ Key points for washing:

- When the collars or sleeves of clothes are seriously dirty, please daub some normal liquid detergent on them.
- To avoid creasing as much as possible, please take the clothes out of the tub immediately after washing.
- Please hang the clothes with hangers of enough widths, stretch them by holding with hands. Then dry them in shade.

1 Turn the **POWER** **ON**.

2 Put the laundry in the wash tub/spin basket.

3 Press the button then select “**SPEED**”.

▶ Select the buttons according to your needs.

4 Press the button.

- The pulsator starts to revolve before flowing water, and the machine will weigh clothes before displaying detergent amount (reference value). (When the lid is opened.)

5 Based on the detergent amount displayed, add detergent to the detergent/bleach dispenser, and then close the lid.

- If you forget to close the lid, [E21] error occurs in 1 minute.

At the end of operation

A “beep” sound will be heard indicating that the course is over.

- Close the faucet and clean the cassette filter.

CUSTOM WASH CYCLES

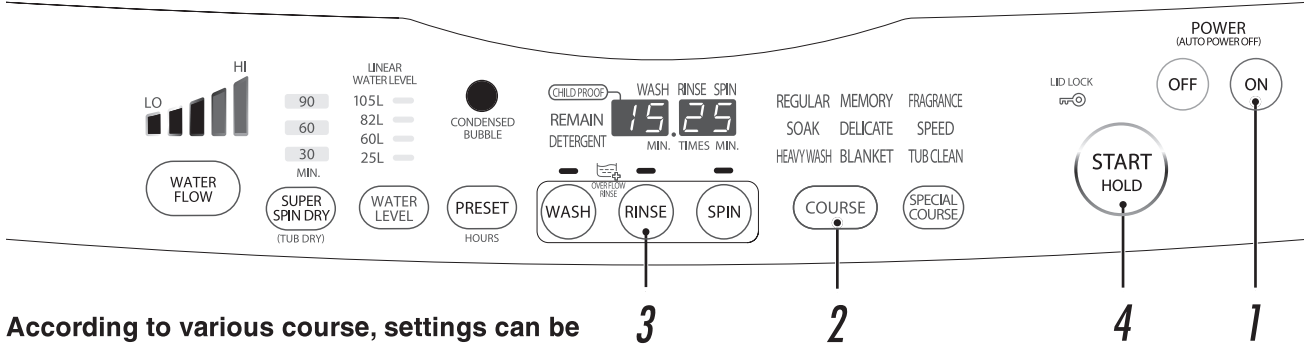

According to various course, settings can be different.

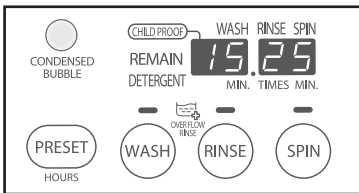

WASH Maximum time is 15 minutes, with the unit of 1 minute.

12 minutes > 15 minutes	Normal smear
Off	None-washing
4 minutes > 6 minutes	Light smear

RINSE Maximum rinsing frequency can be 4 times, with select to rinsing as below.

2 times	1 shower rinse, and 1 static rinse
2 times of overflow rinse	1 shower rinse, and 1 overflow rinse
3 times	2 shower rinse, and 1 static rinse
3 times of overflow rinse	2 shower rinse, and 1 overflow rinse
4 times	2 shower rinse, and 2 static rinse
4 times of overflow rinse	2 shower rinse, and 2 overflow rinse
Off	None-rinsing
1 time	1 static rinse
1 time of overflow rinse	1 overflow rinse

SPIN Maximum time is 9 minutes, with the unit of 1 minute.

6 minutes > 8 minutes	Normal clothes
9 minutes	Thick clothes
Off	None-spinning
1 minute > 2 minutes	Creasing-prone clothes

1 Turn the **POWER** **ON** and put the laundry in the wash tub/spin basket.

2 Select the course.

- You do not need to press any key if the indicator is lighted.
- If you use "MEMORY" course, the system will store the setting. When you power on the machine next time, the "MEMORY" indicator will be lighted.

3 Press the **WASH** **RINSE** **SPIN** buttons separately to change the operation.

- Please see situations details in page 18

► Select the **PRESET** **SUPER SPIN DRY** **WATER FLOW** buttons according to your needs.

4 Press the **START HOLD** button.

5 Based on the detergent amount displayed, add detergent to the detergent/bleach dispenser, and then close the lid.

- If you forget to close the lid, [E21] error occurs in 1 minute.

At the end of operation
A "beep" sound will be heard indicating that the course is over.

- Close the faucet and clean the cassette filter.

Memory Washing of the Custom Setting When you only need to rinse clothes

MEMORY course

This course is to change the operation for the "REGULAR" course of the "CONDENSED BUBBLE", which will be stored into the "MEMORY" course.

In various courses, you can set processes such as washing-spinning and spinning only, or change the setting of the washing time, the rinsing frequency and the spinning time.

Situations	Operations	Washing, Rinsing and Spinning selected
<ul style="list-style-type: none"> Use detergent for twice Dissolve detergent in advance 	Washing only Water retained.	
<ul style="list-style-type: none"> Re-use rinse solution 	Washing-Rinsing Water retained.	
<ul style="list-style-type: none"> Execute separate washing. 	Washing-Spinning	
<ul style="list-style-type: none"> Rinse the clothes that have been washed 	Rinsing only To enhance the rinsing performance, the program starts from draining-spinning with rinsing water retained.	
<ul style="list-style-type: none"> Rinse and spin clothes after wringing out clothes. 	Rinsing-Spinning To enhance rising performance, the program starts from draining-spinning.	
<ul style="list-style-type: none"> Spin other washed clothes Drain used water 	Spinning only Drain before spinning. When draining only is implemented, pre-open the cover and shut down the machine when E2 is displayed.	
<ul style="list-style-type: none"> Change setting during operation 	Washing-Rinsing-Spinning	

※ If you start from rinsing without setting water level , it will be automatically set to the highest level.

■ About washing course combined with the SUPER SPIN DRY

- To select the desired washing course, press the button, and then change the setting except spinning time.
- You can not select the course of "WASH" "SUPER SPIN DRY", or "WASH" "RINSE" "SUPER SPIN DRY" without Spinning Process. When you do not need washing, or rinsing process, please press the buttons.
The "SUPER SPIN DRY" can not be stored , Even if you execute memory course.

SUPER SPIN DRY

When you need to dry clothes or shorten their indoor drying time.

SUPER SPIN DRY

Through setting of the SUPER SPIN DRY for 30 or 60 minutes, you can vapor the water contained in clothes, thus shorten their indoor drying time. In addition, you can basically dry sports wear, chemical fiber or blending fiber by setting SUPER SPIN DRY for 90 minutes (less than 7 kg).

- The hand touch differs depending on the type, weight of clothes, room temperature and moisture. Clothes will be cold due to air drying process, so they may produce a hand touch feeling like the wet ones.



What is the SUPER SPIN DRY?

This is a course which discharge wet air through the high-speed revolving of the wash tub/spin basket, thus vapor the water carried by the clothes.

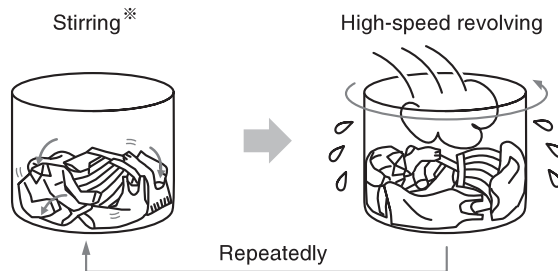



※: Stir for every 15 minutes to unravel the clothes. Stirring may not be necessary, depending on the weight of the clothes.

■ Clothes prohibited for the SUPER SPIN DRY

- Since the SUPER SPIN DRY needs a long time for high-speed revolving, and unravel clothes every 15 minutes, the following articles are not allowed for the process:
- Clothes with unstable color
- Creasing-prone clothes (such as frock, or 100% cotton shirt)
- Deformation-prone clothes
- Water-tight clothes
- Quilt and blanket

■ Method of using SUPER SPIN DRY button

(Ex.) When the “REGULAR” course with “CONDENSED BUBBLE” is being executed

Press the  button to select processing time according to the following sequence or select SUPER SPIN DRY only. Please press the  button for at least 4 times, when you select SUPER SPIN DRY only.

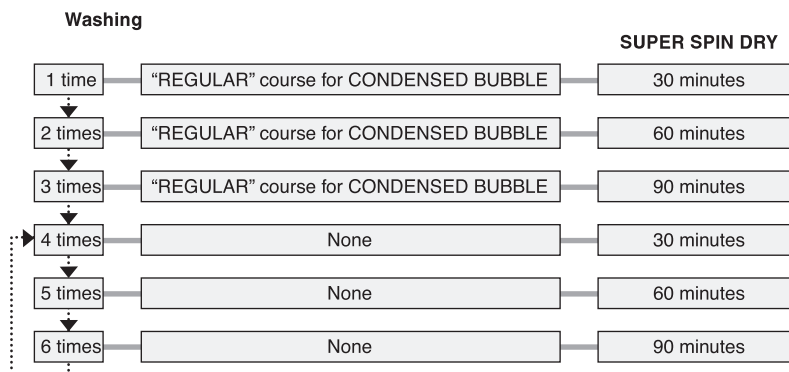

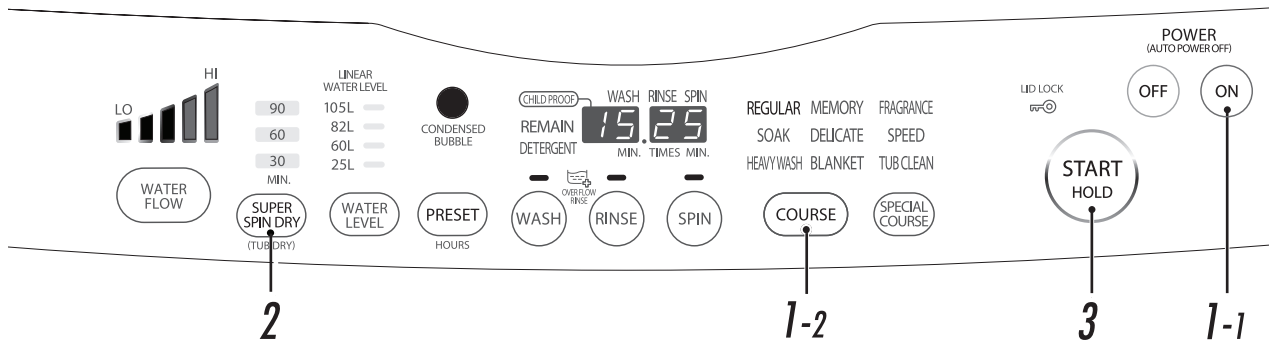

■ Applicable weight reference for the SUPER SPIN DRY

Chemical fiber or blending fiber clothes of less than 7 kg.

■ Reference value of 7 kg.

Too many clothes are subject to creasing and are not easy to spin dry.

■ Setting time and reference value for the SUPER SPIN DRY

- Time can be set as 30 minutes, 60 or 90 minutes. Please base on the following reference values to select what you prefer.
If you want to shorten the indoor drying time of clothes by : 30 or 60 minutes
If you want to dry chemical fiber or blending fiber clothes by : 90 minutes

Tips:

If drying is incomplete, please do it once more.

1 Power , add clothes and select .

- “SUPER SPIN DRY” can not be selected for course of “BLANKET”, “TUB CLEAN” and custom wash without “SPIN”.

2 Press the “” button to select time.

- The time setting indicator of the “SUPER SPIN DRY” will be lighted.
- ▶ Select the  button according to your needs.

3 Press the button.

- The pulsator starts to revolve before flowing water, and the machine will weigh clothes before displaying detergent amount (reference value). (When the lid is opened.)

4 Based on the detergent amount displayed, add detergent to the detergent/bleach dispenser, and then close the lid.

- If you forget to close the lid, [E21] error occurs in 1 minute.

At the end of operation

A “beep” sound will be heard indicating that the course is over.

- Close the faucet and clean the cassette filter.

CHILD PROOF MODE (if you have small children)

CHILD PROOF mode

This model is equipped with CHILD PROOF mode. After this mode is set to ON, the lid can be locked so that children should not fall into wash tub/spin basket during washing or drying. **If you find the accident such as children's falling into the wash tub/spin basket, please take necessary safety action urgently.**

If there are small children who require attention, set this mode ON.

WARNING: Pay attention to small children. Do not leave the lid open. Do not leave the washer filled with water. Never allow children to look into the wash tub/spin basket or play around the washer. Do not place the stand or box etc. near the washer.

HOW TO USE CHILD PROOF MODE

Press the **START HOLD** button, then the washing machine begins operating, put in the detergent and softener follow to detergent guide then follow the instruction below:

Hold down the **PRESET** button, press the **START HOLD** button once again.

- A buzzer will sound and the CHILD PROOF mode indicator will be light on.

Once the CHILD PROOF mode is set, it is stored in memory.



Canceling the CHILD PROOF mode

Hold down the **PRESET** button, press the **START HOLD** button once again.

- A buzzer will sound and the CHILD PROOF mode indicator will be light off.

You can cancel this mode while operating.



■ Cannot add detergent while child proof mode. The lid lock is activated.

■ If accident occur when strongly pull up lid when lid lock in child proof mode operate. The buzzer will be sound and operation will stop. Subsequently if that state persists about 5 seconds, it will be detected as an alarm and water will be drained.

PRESET MODE

How to use preset mode

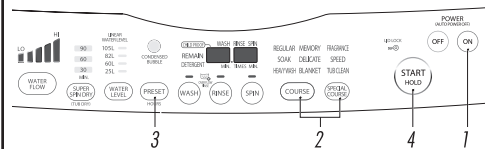

TO CANCEL PRESET MODE

- Press the **POWER OFF** when you want to cancel preset mode.
- If you need to change preset time after preset mode started, please press **POWER OFF** then press **POWER ON** and reset to new preset time.

TO CONFIRM PRESET TIME

- Display preset time when pressing the **PRESET** button.
- The finished times for the preset and the actual times are different because of the water pressure and the drainage condition.

- 1 Turn the **POWER ON**.
 - ▶ Put the laundry in the wash tub/spin basket and select your favorite cycle or water level. Set the custom wash cycle.
- 2 Select the **COURSE**.
- 3 Press the **PRESET** button to preset the time.
 - The displayed time can be changed from 2 to 24 hours by increasing 1 hour per press.
- 4 Press the **START HOLD** button.
 - Check if the faucet is on.
- 5 Put the detergent according to the detergent guide and then close the lid.

POWDER DETERGENT

Pull the detergent case, then place the detergent evenly in the case. Then shut the case.

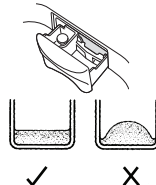

LIQUID DETERGENT

Pour the liquid detergent into the bleach dispenser.

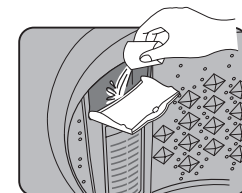

OPTION MODE

Water level indicate of AW-DC1700W series.

If you feel the amount of water is less or much

Water level is automatically set to suit the amount of laundry. If you feel the amount of water is less or much, you can adjust it as the following.

Water Level Indicate of AW-DC1500W series.

LINEAR WATER LEVEL
102L <input type="checkbox"/>
82L <input type="checkbox"/>
60L <input type="checkbox"/>
25L <input type="checkbox"/>

Water Level Indicate of AW-DC1300W series.

LINEAR WATER LEVEL
100L <input type="checkbox"/>
82L <input type="checkbox"/>
60L <input type="checkbox"/>
25L <input type="checkbox"/>

If you feel the amount of water is much.

If you feel the amount of water is less.

Turn the POWER ON with pressing the WATER LEVEL button.

Adjust by pressing WASH .

Press twice. (Decrease approx. 10L.)	Press once. (Decrease approx. 5L.)
LINEAR WATER LEVEL	LINEAR WATER LEVEL
105L <input type="checkbox"/>	105L <input type="checkbox"/>
82L <input type="checkbox"/>	82L <input type="checkbox"/>
60L <input type="checkbox"/>	60L <input checked="" type="checkbox"/>
25L <input checked="" type="checkbox"/>	25L <input type="checkbox"/>

Adjust by pressing PRESET .

Press once. (Increase approx. 5L.)	Press twice. (Increase approx. 10L.)
LINEAR WATER LEVEL	LINEAR WATER LEVEL
105L <input type="checkbox"/>	105L <input type="checkbox"/>
82L <input checked="" type="checkbox"/>	82L <input type="checkbox"/>
60L <input checked="" type="checkbox"/>	60L <input type="checkbox"/>
25L <input type="checkbox"/>	25L <input type="checkbox"/>

Turn the POWER OFF . (Finished adjusting)

* Set it once, it is written in memory. You don't have to set it on each laundry.

If you wish to turn off the end buzzer sound

- You can turn off the buzzer sound by

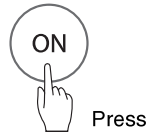
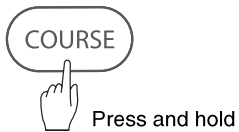

1 Press the COURSE button and hold. Then press ON button.
After buzzer beeps 3 times, the end buzzer disabled.

2 Follow this instruction when you want to reset to enable the buzzer.

* After you set the buzzer, the washer will keep the setting in memory. So it is not necessary to reset the buzzer every time.

If you want to return initial setting

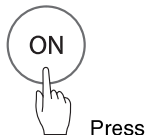

1 Press the SUPER SPIN DRY and hold. Then press the ON button.

- Three beeps will be heard and the current setting will be deleted about 5 second later.

2 Press the OFF button.

- All setting will be restored to initial status.(Factory setting)

OPTION MODE

If you wish to change the shower rinse to the static rinse

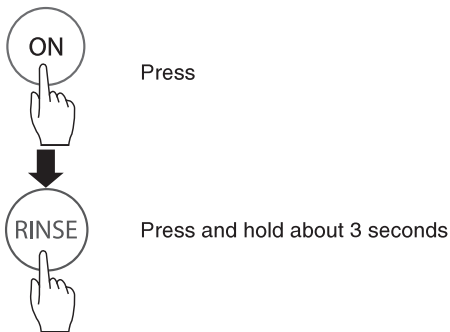

- 1 Press **ON** button to turn on the washer.
- 2 Press the **RINSE** button and hold about 3 seconds. The buzzer sound will be heard and the course will be set within 5 seconds. After that, press **OFF** button to turn off the washer.
 - Follow this instruction for the shower rinse, and the buzzer sound will be heard.
 - After the setting, the washer will keep the setting in memory. So it is not necessary to reset every time.

RESUME FUNCTION (POWER FAILURE RECOVERY)

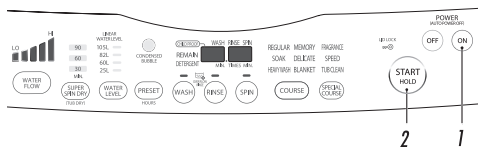

If a power failure occurs during operation, the washing machine memorizes the remaining process. After the electricity recovers, you can resume it.

- 1 Turn the **POWER ON** .
 - ▶ The progress and course indicators of the remaining process will be blink, and the buzzer sounds for 5 seconds.
- 2 Press the **START HOLD** button.

NOTE

- For "PRESET MODE", if the power failure occurs before the machine starts operating, the machine will cancel the preset time. Therefore, you have to reset the preset time again.
- Press the **OFF** button to clear the remaining process.

LID LOCK

Instruction: Do not open the lid while  lights up. (The lid may be damaged.)

At the end of operation, the lid will be automatically unlocked.

When you need to cancel the lid lock

■ During operation

Press the **START HOLD** button to hold the operation.

When  lights off, the lid can be open.

■ While the power is off

Turn the power on. When  lights out, the lid can be open.

(When the power is turned off or shut down during operation, the lid still remain locked.)

RECOMMENDED DETERGENT AMOUNT

■ Reference value of detergent amount

Rated capacity (kg)	Display of detergent amount (scoop)	Manual Water Level Setting			Detergent			Softener	
		AW-DC1700W	AW-DC1500W	AW-DC1300W	Powder		Liquid	Normal type	Concentrated type
					Normal type	Concentrated type	Concentrated type		
14-16	1.9	105 L	102 L		Approx. 140g	Approx. 70g	Approx. 70mL	Approx. 70mL	Approx. 23mL
12	1.8			100 L	Approx. 134g	Approx. 67g	Approx. 67mL	Approx. 67mL	Approx. 22mL
	1.7				Approx. 126g	Approx. 63g	Approx. 63mL	Approx. 63mL	Approx. 21mL
	1.6				Approx. 118g	Approx. 59g	Approx. 59mL	Approx. 59mL	Approx. 20mL
7	1.5	82 L	82 L	82 L	Approx. 110g	Approx. 55g	Approx. 55mL	Approx. 55mL	Approx. 18mL
	1.3				Approx. 94g	Approx. 47g	Approx. 47mL	Approx. 47mL	Approx. 16mL
	1.2				Approx. 88g	Approx. 44g	Approx. 44mL	Approx. 44mL	Approx. 14mL
4	1.1	60 L	60 L	60 L	Approx. 80g	Approx. 40g	Approx. 40mL	Approx. 40mL	Approx. 13mL
	1.0				Approx. 72g	Approx. 36g	Approx. 36mL	Approx. 36mL	Approx. 12mL
	0.8				Approx. 58g	Approx. 29g	Approx. 29mL	Approx. 29mL	Approx. 10mL
1	0.5	25 L	25 L	25 L	Approx. 36g	Approx. 18g	Approx. 18mL	Approx. 18mL	Approx. 6mL
Blanket					---	---	Approx. 70mL	Approx. 70mL	Approx. 23mL

- The detergent amount (reference value) for “REGULAR”, “SOAK”, “HEAVY WASH”, “MEMORY”, “DELICATE”, “FRAGRANCE” and “SPEED” course is displayed on the basis of 55 liters of water level and 1 measuring scoop amount. In addition, please refer to the instruction manual of detergent for amount.
- Detergent powder includes composite detergent and soap powder. The letter is made of natural oil. Please confirm the detergent label.
- Water level changes according to the specific detergent type.

Tips

- Please do not add excessive detergent. (Please refer to the table list shown above to add detergent based on the weight of clothes.)
Too much detergent will produce overflowing foam, which may wet the floor and cause accident.
- Please avoid splashing detergent onto the cover or operating panel. If any, please clean them immediately.

LAUNDRY GUIDE

Using the detergent and bleacher

Please refer to the instruction manual of detergent and bleacher for amount and method before using.

Liquid detergent

- Please add it into the entry gate of detergent / bleach dispenser.
- When liquid soap is frequently used, please implement "TUB CLEAN" regularly to eliminate soap gas that usually appears.

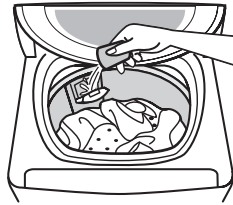

Liquid bleacher

- Please dilute the bleacher with 3 times of water before adding it into the entry gate of detergent/bleach dispenser.
- Please do not add the bleacher directly into basket or splash it onto clothes. Otherwise it may cause discolor or cloth damage.
- While using PRESET mode, please add powder detergent before adding liquid bleacher.

Powder detergent/bleacher

- Please add it into the entry gate of detergent/bleach dispenser.
- For "PRESET" mode please put detergent into Softener/Detergent (Preset) case (refer to page 21).



When changing the position of the entry gate

- Power on and open the lid, then set to spinning only and start. When "E21" is displayed, please turn the wash tub/spin basket with hand to an appropriate position for adding detergent and bleacher. Turn off the system.

Using the softener

Please refer to the instruction manual of softener for amount and method before using.

When the machine is operating, please press **START HOLD** before adding softener.



- Please add softener with appropriate amount into the softener case, on the basis of reference value displayed. The softener will be added automatically into the basket during the final rinsing.
- Please keep the case of softener well.

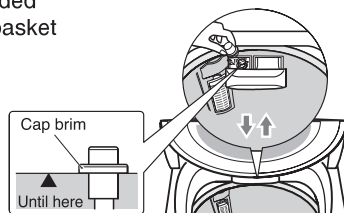

Tips

- Please make sure to press the softener case in place. Do not have the agent level higher than the cover brim of the box. Otherwise, too much agent will overflow during washing.
- Please do not leave softener in the case for a long time, otherwise it may become solidified.
- Please avoid splashing the agent onto operating panel, if any, clean it immediately.
- Please do not open the case during rinsing & flowing water, otherwise the water may splash out.

- Due to the siphoning structure, some liquid may remain inside the case, which is not abnormal.
- Condensed liquid may be too thick to add. Please dilute it with the ratio of 1:2 before adding.

Measuring cap

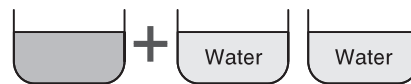

Softener (formulated concentrate)

When is the best for adding softener?

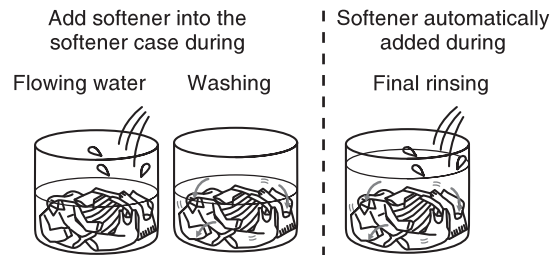

- Please add softener into the case before the end of washing. It will be automatically added into wash tub/spin basket during final soaking & rinsing.

INSTALLATION

Choosing an installation location

Install your washing machine in a level, stable place.

- It is dangerous to place the washing machine in an unstable location since it may move during vibration.
- It will increase the sound produced by the machine when it vibrates during use.



Avoid place where the machine is exposed to direct sunlight.

- Plastic parts may become deformed or discolored.



When you move washing machine, hold the handles on the sides.

There are moving parts, electrical parts and steel plates which may cause electrical shock or injury.

- Never touch on the cabinet bottom by hands.
- Never lift at the cabinet bottom by hands.



Avoid places where the machine may become frozen during cold weather.



Allow a space of at least 5 cm from the sides and rear of the machine to the nearest vertical object.

- When placed too near to walls or other objects, the vibration of the machine during operation may cause them to shake.

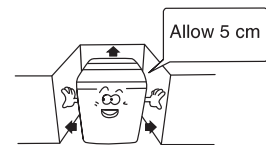

When the machine is covered.

Do not use the cover made of chloric vinyl. Sometimes it damages resinous parts and painted surface. When you use the cover made of chloric vinyl, put the cloth between the machine and the cover.

Leveling the washing machine

When adjusting the legs, supports the top of the machine. Do not support the machine bottom.

1 Adjust the legs so that the machine does not move.

Note: After adjustment, lock the nuts of the legs by rotating them in the direction of the arrow. Make sure so that the bottom of the main body front does not reach the floor. If the bottom is in touch with the floor, then it will be the cause of shaking and abnormal noise.

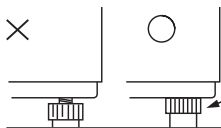
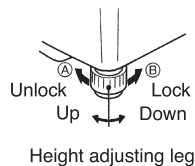

Tighten nuts of adjustable legs and lock them.

2 Check the position of the air bubble in the floor level indicator.

- If the bubble is not positioned inside the circle, adjust the height by rotating the leg caps.

Note: Check the floor level indicator directly from above.

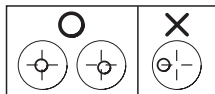

3 Depending on locations of the bubble in the horizontal level indicator, place caps and lock legs (Make sure to fix adjustable legs.)

- Mount the leg caps on the right-hand legs. Rotate the height adjust legs to perform height adjustment.

(Ex.) The washing machine is tilted towards the right.

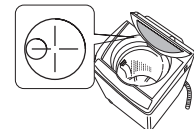

4 Hold down the diagonal line of the washing machine and make sure that no rattling occurs.

- Despite the fact that the bubble is inside the circle, the rattling exists. Then shaking motion becomes larger or some abnormal noise comes out. Make sure to readjust in case the washing machine rattles.

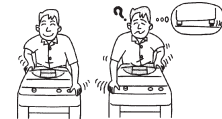

INSTALLATION

Installation the grounding

- Be sure to ground your washing machine when installing. When connecting or disconnecting the ground wire, be sure to first remove the power plug from the AC socket.
 - In case of the machine with two conductor cord connect the ground wire to a proper ground before plugging the power cord into the socket.
 - In case of 3-core cord the ground pin in the plug should be connected to the proper point of the socket.
- Do not connect the ground wire in any of the following places under any circumstances:
- Do not connect the ground to gas piping. There is a danger of fire or explosion.
 - Do not connect the ground to telephone lines or lightning rods. There are dangerous during thunder or lightning storms.
- Also, as underground water pipes are often made of plastic, don't place grounding rods near them.

Two-core flexible cord

When using the ground terminal on an AC outlet:

Ensure that the ground wire is securely connected to the ground terminal.

- An optionally available grounding rods is re-commended for use. The grounding rod should be planted in the dampest ground possible.

Three-core flexible cord

WARNING THIS APPLIANCE MUST BE EARTHED.

As the colors of the wires in the main lead of this appliance may not correspond with the colored marking identifying the terminals in your plug, proceed as follows.

- The wire which is colored green-and-yellow must be connected to the terminal in the plug which is marked with the letter E or by the earth symbol or colored green or green-and-yellow.
- The wire which is colored blue must be connected to the terminal which is marked with the lettered N or colored black.
- The wire which is colored brown must be connected to the terminal which is marked with the letter L or colored red.

Installing the drainage hose

Moving the hook

- When inserting the drainage hose into a wash pan or onto a drain pipe, the hook may be moved to facilitate the installation.
- When hooking the hose hook into the slot provided on the body of your washing machine, move the hook back to its initial position.

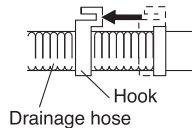

- Insert the drainage hose in as far as it will go, then use the accessory hose band to secure it tightly.
- Secure the hose tightly. An improperly secured hose may cause leakage.
- Lock hose band distance to cabinet about 10 mm as figure.
- When attaching the drainage hose to a wash pan, etc., either leave a gap between the end of the hose and the adjacent surface, or cut the hose diagonally to ensure proper drainage.

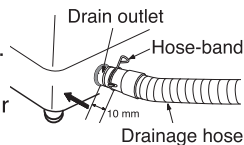

- ※ Allowing the flat end of the hose to come in contact with the flat surface of the washing machine will impair drainage.

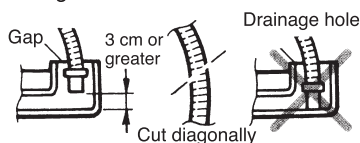

Drainage hose extension

- Pay close attention to the height of the drainage hose and articles over which it passes. If the drainage hose is too high, proper drainage may not be obtained.
- The length of the drainage hose may be extended to as much as 3 m if kept the same level.

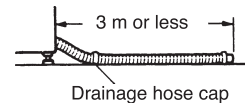

Caution:

- If the level of the threshold and the drainage hose is high, the washing machine may not be drained.

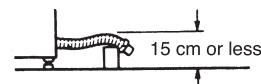

- Be careful not to rub the drainage hose. Do not insert the drainage hose under the washing machine. They may be damaged the drainage hose.

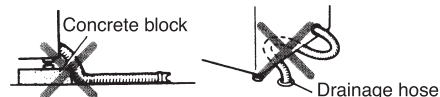

INSTALLATION

Attaching the water inlet hose to the faucet

If you attach the water inlet hose completely, it may cause a water leakage.

Faucet shape

Wall-mounted faucets are best.



The distance is needed
1.6 cm or more

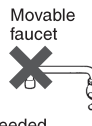

Caution

- The old inlet hose should not be reused.
- If the faucets are not suited, please contact your dealer.
- Do not connect the hot water supplying convenience.
- In order to provide a permanent source of water for your washing machine, it is suggested that a branching water pipe (available separately) be used.

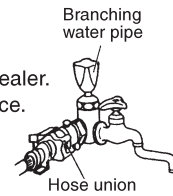

Attaching the hose union

- 1 Push the lock lever of the water inlet hose. Pulling the sleeve down, lower the entire hose to disconnect the hose union.
- 2 Check the diameter of the faucet. When the faucet mouth is large, loose the screws and remove the inside ring to facilitate attachment.
- 3 Loose 4 screws of the hose union, push the hose union to the water faucet.
- 4 Tighten the four screws evenly around the faucet. In this time check the gap is approx. 4 mm between the nozzle and the ring.

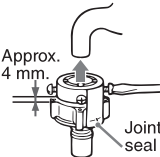
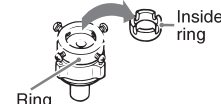
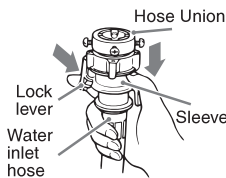

- 5 Remove the seal from the union and turn to the arrow destination the nozzle to tighten securely.
- 6 Check the gap is approx. 1 to 3 mm between the nozzle and the ring.

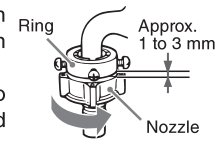

- If the gap is wide, it may cause the water leak.
- If it cause the water leakage during operation, tighten the nozzle more securely.

Caution

- If you attach the hose union again because of moving house etc., loose the gap is approx. 4 mm between the nozzle and the ring. Then attach it according above methods. They are preventable the water leakage.

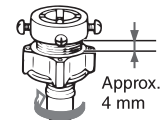

Connecting the water inlet hose

- 1 Pull the sleeve down, then insert the water inlet hose.
- 2 Separate the sleeve until a click is heard, then push it up.
- 3 Check to ensure that the lock lever is hung on the nozzle. Next, check to ensure that the water inlet hose does not come off by pulling down on it.

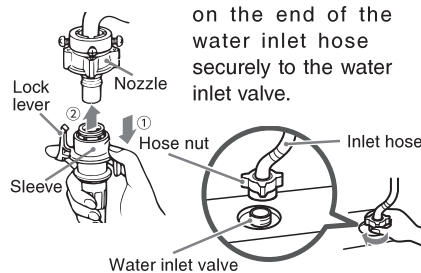

- 4 Tighten the hose nut on the end of the water inlet hose securely to the water inlet valve.

Caution:

- Check to ensure that the water inlet hose is properly installed by turning the water on and checking for leakage. If there is leakage, connect it from the first.
- If you remove the water inlet hose after supplying water, water may splash. Refer to the following "Removing the water inlet hose".

If the filling water becomes not good

The water inlet valve may be clogged by lees or grimes.

- You should remove inlet hose and clean valve filter by brush.
- If you remove the water supply carelessly, water may splash. Therefore, use the following procedure.

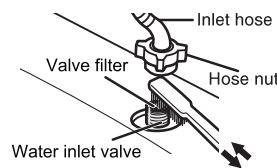

Removing the water inlet hose

- 1 Turn off the water faucet.
- 2 Press the **ON** button to open the washing machine then press the **START HOLD** button.
- 3 After water level indicator will light up, press the **OFF** button.
- 4 Loosen the hose nut and then remove inlet hose.

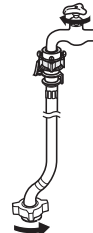

MAINTENANCE

CASSETTE FILTER

Clean the lint trap at the end of operation.

Cassette filter

■ How to remove

Hold the upper side of the cassette filter, and push down and pull it at the same time.

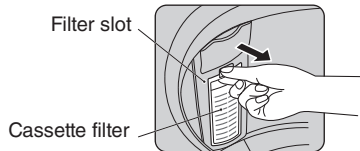

■ How to set in

Hold the filter case with its top side up. Put the lower side of the filter case in the filter stand, and then push it until a "click" sound is heard.

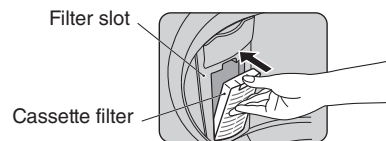

Filter cover

■ How to remove

Turn over the filter, and then slide the filter case in the arrow direction of the following figure (①) to remove it (②). Clean inside the filter cover and the filter case.

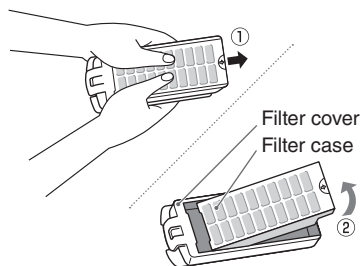

※ When it is difficult to remove the filter case due to lint attached, wet it with water to soften the lint.

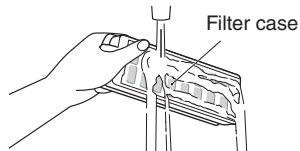

■ How to set in

- ① Set the filter case to the filter cover as follows.
- ② Press down the filter cover case until a "click" sound is heard.

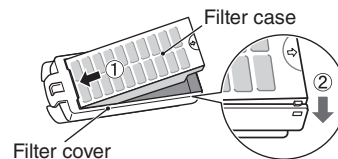

■ When the filter valve inside the filter cover is loosened

- ※ If the filter valve is loosened, lint may not be collected.
- ① Set the filter valve to the filter case while aligning its concavity and convexity to those of the filter case.

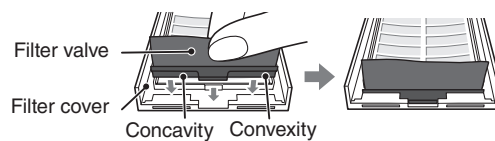

- ② Insert the groove of the filter valve to the click at the center of the filter cover.

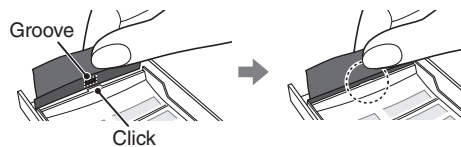

MAINTENANCE

Softener/Detergent case(Preset mode)

Remove the case to clean it. In addition, wipe away any dirt from the water inlet valve.

Removing the case

- 1 Removal procedure;
Pull the softener/detergent case toward you, then lift it for removal.

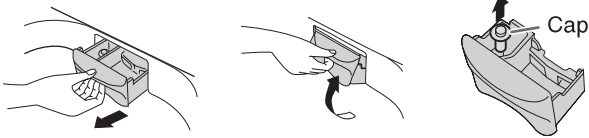

- 2 Remove the cap of the softener/detergent case.
- 3 Clean the case by water. Wipe the insertion case by wet cloth.

Remounting procedure

- 1 Mount the cap of the insertion case. If the washing machine operates without the cap in place, the softener does not enter.
- 2 Lift the case obliquely in the same way as you remove it, and insert it deeply along the guides.

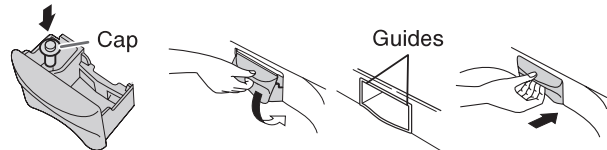

Washing machine body and panel

Before performing any maintenance on your washing machine, be sure to remove the electrical plug from its power source.

The main body and control panel may be cleaned by wiping with a soft cloth soaked in water.
(Hard-to-remove dirt may be cleaned by wiping with a soft cloth soaked in a mild detergent.)

Caution: Never clean the body or control panel with benzene, thinner, cleanser, or other chemical cleaners. Use of such chemicals can discolor or damage parts.

If the stainless basket rust for external reasons

■ Stainless rust

Please clean the rust by a sponge or a soft cloth with a cream cleanser.

* Do not use metallic brush because the body may scratch and easily rust.

The stainless basket usually prevents the rust.
However, there is possible to have it. Please follow the recommendation below to prevent rust.



Recommendation

- Do not keep the metallic objects into the machine, e.g. Hair clip.
- After draining the water, the rusted water will be drained. This will cause the accumulated rust inside the washing machine. Clean it again with clean water.

Detergent/Bleach Dispenser

Wipe or Wash out any remaining detergent.

If there is any remaining detergent hard to be removed, use the "TUB CLEAN" course.

- Before put detergent or bleach to in the detergent/bleach dispenser, remove water in its inlet.
With any remaining water, detergent may be hardened and attached.

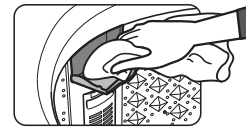

In case of water may freeze

Drain all water from the basket, drainage hose and water inlet hose after using the machine.

If the water is frozen

- 1 Remove the water inlet hose and pour in warm water (under 40°C).
- 2 Fill warm water (under 40°C) into the basket until the pulsator is completely covered. Leave it for 30 minutes. Then check to see whether the pulsator can be turned by hand.

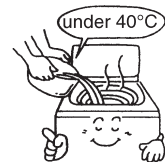

MAINTENANCE

Cleaning the tub

“TUB CLEAN” course



The dirt from clothes or waste water on the wash tub/spin basket will cause the smell or the problem of water draining. Such dirt from the washing process will then make the laundry dirty. If you are in such case, please use “TUB CLEAN” program once a month. Or in case the clothes have been starched, please use the “TUB CLEAN” program to remove the dirt of the starch from the wash tub/spin basket.

“TUB CLEAN” Process

Water intake/Stir (※1)	about 12 min
Soak	about 20 min
Wash	about 5 min
Drain/Spin (※2)	about 5 min
Water intake/Stir (※1)	about 12 min
Rinse	about 5 min
Drain/Spin (※2)	about 5 min

※ 1 The pulsator stirs while the water level increases gradually.
※ 2 The water spins while draining out.

- Do not use “TUB CLEAN” program continuously.

- 1 Turn the **POWER**  .
 - 2 Press the  button and select “TUB CLEAN”.
 - 3 Press the  button.
 - No indicator. All indicator will light off.
 - 4 When the pulsator starts to stir, add the chlorine-type whitening detergent about 300 ml. to the wash tub/spin basket.
 - Add it at the first intake water.
 - Do not put any clothes in the basket during the “TUB CLEAN” program.
 - 5 Close the lid.
 - If the lid is opened during the operation, the operation will stop before the draining and rinsing process.
- Finish “TUB CLEAN” process.**
- Beeping when the operation is finished.

■ When you want to dry the wash tub/spin basket.

TUB DRY course

- Run “TUB DRY” after washing is finished, to prevent mildew by removing the moisture of the wash tub/spin basket. Please run the course once a week.
- ※ Please do not add clothes during the course.

Tips

- Mildew of wash tub/spin basket occurs depending on the environment.
- Once mildew occurs, it can not be removed by “TUB DRY” process. Therefore, it is recommended to run “TUB CLEAN” regularly.

- 1 Power  and press the  button 4 times.
- 2 Close the lid and press the  button.
 - High-speed revolving for about 30 minutes can dry the wash tub/spin basket through air intaking and revolving the pulsator.

BEFORE CALLING THE SERVICEMAN

The following are not malfunction.

Course	Status	Check
During operation	Water flows out of the drainage hose when the machine is used at first time.	<ul style="list-style-type: none"> Water remains during the performance test in factory.
	The wash tub/spin basket and pulsator do not run immediately.	<ul style="list-style-type: none"> The clutch is switched.
Washing	Pulsator revolves before and during flowing water.	<ul style="list-style-type: none"> Before flowing water → Check the weight of clothes. During flowing water → Dissolve detergent with high-efficiency.
	Water supply operates in the middle of washing.	<ul style="list-style-type: none"> If the indicator of CONDENSED BUBBLE is lighted, water will be flowed at a low level during washing. If water level reduces during washing, water will be automatically added.
	Beeper rings and detergent is discharged.	<ul style="list-style-type: none"> When child proof mode is set, this event will occur if the cover is opened.
	Water level is not suitable for the actual weight of clothes.	<ul style="list-style-type: none"> During CONDENSED BUBBLE course, water will be flowed as needed while washing. Therefore, the water level looks lower at the beginning. When the display of WATER LEVEL is blinking, it means flowing water is not yet finished. Water level depends on the weight of clothes. Many chemical fiber clothes or adding of soaked clothes will be regarded as heavy articles by the sensor. If the water level is not suitable, please adjust it according to the actual weight of clothes. If the water level always appears slightly less or more than the suitable amount, you can adjust the automatic setting.
Rinsing	The water for final rinsing looks somewhat turbid.	<ul style="list-style-type: none"> Turbidity is caused mainly zeolite included in the detergent. Under such situation, please increase rinsing frequency or switch shower rinse into static rinse.
	Flowing water is not available after the start of rinsing.	<ul style="list-style-type: none"> When there is no water in the wash tub/spin basket, the operation is started from spinning course to remove the water or detergent contained in clothes. Water will be re-flowed after spinning. (If there is water in the wash tub/spin basket, this situation will occur from draining.)
	Static rinse executes in spite of the fact that you set shower rinse.	<ul style="list-style-type: none"> When the water level is lower than 60 liters, overflow rinse will automatically switch into static rinsing. Static rinse may execute when clothes lean to one side in the tub while or before spinning.
Spinning	Water is not removed completely after spinning.	<ul style="list-style-type: none"> Spinning performance changes according to the type of clothes. If you need further spinning, please run "SUPER SPIN DRY" function for 30 minutes, 60 minutes or 90 minutes.
	Spinning does not start. The power cannot be turned on.	<ul style="list-style-type: none"> There are some outage time for safety reason when you start soon after stopping.
	The water supply suddenly starts or the machine executes static rinse before or while spinning. Washing time is extended.	<ul style="list-style-type: none"> When clothes lean to one side in the tub. A safety switch activates and corrects leaning automatically. Water supply operates and fill the tub with water. Then spin again after unraveling the clothes. ※ If the situation is not corrected after two cycles of the above operations, "E31" or "E32" will be displayed, and a warning sound will be heard at the same time.

BEFORE CALLING THE SERVICEMAN

Course	Status	Check
Others	Remaining time appears to have changed during operation. Operation does not end within remaining time.	<ul style="list-style-type: none"> Remaining time displayed is only for reference. The actual time changes depending on water pressure, draining and sensor checking.
	“REGULAR” course is maintained even after other selection is made.	<ul style="list-style-type: none"> Is the indicator of CONDENSED BUBBLE still lighted?
	The indicator of CONDENSED BUBBLE is off.	<ul style="list-style-type: none"> CONDENSED BUBBLE can not be enabled during “BLANKET” and “TUB CLEAN” course.
	Automatic shut down function does not work.	<ul style="list-style-type: none"> Is error information displayed? Please confirm the detail on the display.
	Smear on the clothes are not cleaned.	<ul style="list-style-type: none"> Is soap powder or liquid soap used? They tend to contaminate the wash tub/spin basket, which may contaminate clothes during washing. Is wash tub/spin basket cleaned after starching? Otherwise, the sticking starch may contaminate clothes during washing. ※ If such above-mentioned situation occurs, please run TUB CLEAN process.
	Detergent retains on the clothes or filter.	<ul style="list-style-type: none"> Detergent is not easy to dissolve with a low water temperature (under 10°C). If you put buoyant clothes such as nylon shirts or heavy jeans on the other clothes, Detergent residue tends to remain on them. So, Please put them under the other clothes. If detergent residue is found, please increase rinsing frequency.
	There is bubbling noise during draining.	<ul style="list-style-type: none"> The sound occurs when water and air are mixed. It is not abnormal sound.
	There is phut or chink during power-on or operation.	<ul style="list-style-type: none"> The phut produced during power-on is not abnormal. When the machine shifts from “WASH” to “SPIN”, some chink is produced during SUPER SPIN DRY and is normal.
	Water drained contains rust.	<ul style="list-style-type: none"> Please do not use the water until it becomes clear. If rust-contained water is used, it may cause yellow-turning of the clothes. To recover, the contaminated clothes need reverting type bleacher, which is not applicable for colorful cloth.
	Radio gives noise. TV gives unclear display.	<ul style="list-style-type: none"> Please keep the washing machine away from radio or TV with a distance of over 3 m.
Operating panel feels hot.	<ul style="list-style-type: none"> It is due to the heating of electronic components. 	









BEFORE CALLING THE SERVICEMAN

“Abnormal display of operating panel”, “interrupted operation” or “none-movement after button pressed” may be due to external noise or disturbance. If so, please unplug and re-plug the power supply before re-confirming the problem.

If the following event occurs, None operation	Sections to be checked
Does not operate	<ul style="list-style-type: none"> • Is power supply cut? • Is the household circuit fuse burnt or is the circuit breaker cut? • Is the power plug properly connected? • Is the power supply on? • Is the “START/HOLD” button pressed? • Is the machine under PRESET mode?
Water leakage	<ul style="list-style-type: none"> • Is the structure of water faucet suitable? • Is the drainage hose connector loose? • Is the water supply port inclining or loose? • Is the water supply port blocked by sundries? • Does the drain hose unfit its accessories? • Is the drain hose disconnected or broken? • Is the drain hose changed in a right way? <div data-bbox="1052 600 1416 827"> <p>Please check.</p> </div>
Abnormal noise and Large vibration	<ul style="list-style-type: none"> • Is the machine inclining or shaking? Instability will produce vibration or noise during spinning. • Is the electric wire, grounding wire or water-flowing hose touching the machine? • Is the base plate of the machine touching the floor? This will produce large vibration during spinning. • Do clothes lean to one side? This will make the tub touch the outer cover of the washing machine while washing or spinning, and produce large noise and vibration while spinning. • Is there anything like match, ear-picking tool or metal piece carried by the clothes? • Is the drain hose handled correctly? Please cut the hose if it is too long, it needs to be attached with sleeve at its end before using. <div data-bbox="935 894 1416 1100"> </div>
Softener overflows	<ul style="list-style-type: none"> • Is the softener added higher than the upper brim of the dispenser? Too much softener will overflow during washing.

BEFORE CALLING THE SERVICEMAN

When the following information is displayed

Display	Sections to be checked
	<p>Is there anything uncommon related to the drainage hose?</p> <ul style="list-style-type: none"> • Is the drainage hose well installed? • Is the drainage hose lying down? • Is the drainage hose frozen? • Is the drainage hose broken? • Is the sleeve at the end of the drainage hose immersed into water? • Is the drainage hose blocked by sand, mud or thread?
	<ul style="list-style-type: none"> • Is the lid open?
	<ul style="list-style-type: none"> • Is the lid lock stuck with any foreign materials? • Is the lid completely closed? • Is the lid completely locked?
	<ul style="list-style-type: none"> • Is the center gravity of clothes shifted? • Is the washing machine inclining or installed on an oblique floor?
	<ul style="list-style-type: none"> • Is the problem similar to that of E1? → Turn to the handling procedures of E1, if so. • Is the problem similar to that of E31? → Turn to the handling procedures of E31, if so.
	<ul style="list-style-type: none"> • Is water line open? • Is water line frozen? Is water supply cut off? • Is any dust attached to the mesh of water supply pipe? (When the water pressure is considerably low (3 litre/minute or less), "E5" will be displayed.)
	<ul style="list-style-type: none"> • Is there any water in the tub during SUPER SPIN DRY?
	<ul style="list-style-type: none"> • Are the clothes wringing together? • Are there too many clothes in the tub?

※ As for information display beyond the above-mentioned details, or the above-mentioned solutions do not work, please disconnect the power plug and contact technicians for repairing.

HANDLING METHOD FOR EMERGENCY

When the machine takes on abnormal operation, please disconnect the power plug and send it to our service agency for handling. Never disassemble the machine by yourself, for safety reasons.

SPECIFICATIONS

Model	AW-DC1700W series	AW-DC1500W series	AW-DC1300W series	Model	AW-DC1700W series	AW-DC1500W series	AW-DC1300W series
Type	Fully automatic washing machine			Maximum water pressure	1.00 MPa		
Washing system	Vortex system			Minimum water pressure	0.03 MPa		
Rated voltage	230-240 V~			Quantity of water	105 L	102 L	100 L
Frequency	50 Hz			Quantity of used water	195 L	190 L	185 L
Dimension [WxDxH]mm	690 x 700 x 1110			Operation time [Wash only]	15 min		
Rated capacity [Dry Clothes Weight]	16 kg	14 kg	12 kg	Operation time [Regular cycle]	64 min		63 min
Maximum rated power input	460 W	430 W	400 W	IP Number	IPX4		
Net weight	48 kg			Class of appliance	Class I		

TOSHIBA
Leading Innovation >>>

MANUFACTURED BY
TOSHIBA CONSUMER PRODUCTS (THAILAND) CO., LTD.

MADE IN THAILAND