

Appliance Documentation

CS 1400

CS 1611

CS 1660

Combined refrigerator-freezer 75 cm wide with NoFrost



Contents

1.0	Operating and control elements	3
2.0	Functions at a glance	4
3.0	Description of the appliance	5
3.1	Sensor positions, schematic diagrams	5
4.0	Main components and their functions	6
4.1	Electrical components and functions	6
4.1.1	General	6
4.1.2	Refrigerator compartment	6
4.1.3	Freezer compartment	8
4.2	Refrigeration components and functions	10
4.2.1	Refrigerator compartment	10
4.2.2	Freezer compartment	10
5.0	Assembly instructions / replacement of parts	11
5.1	General	11
5.1.1	Electronic control panel	11
5.1.2	Power electronics	12
5.1.3	Top door hinge	14
5.1.4	Bottom door hinge	15
5.2	Refrigerator compartment	16
5.2.1	Magnet and reed contact for door recognition	16
5.2.2	Cable feedthrough in door	18
5.2.3	Air sensor	19
5.2.4	Evaporator sensor	20
5.2.5	Fan	20
5.2.6	Replacement of the base of the water filter (CS 1660)	21
5.2.7	Lighting (CS 1611, CS 1400)	22
5.2.8	Lighting (CS 1660)	24
5.3	Freezer compartment	25
5.3.1	Air sensor, evaporator module and fan module	25
5.3.2	Temperature fuse, evaporator sensor and defrost heater	26
5.3.3	Fan and reed PCB	28
5.3.4	Automatic IceMaker (CS 1660)	29
5.3.5	Lighting (CS 1660)	30
6.0	Technical data	31
6.1	General	31
6.2	Refrigerator compartment	31
6.3	Freezer compartment	31
7.0	Service menu	32
7.1	Manual defrosting	32
7.2	Demo mode	33
7.3	Panel test	34
7.4	Sensor test (display of temperature) and door contact test	35
7.4.1	Refrigerator/freezer compartment	35
7.4.2	Automatic IceMaker (Does apply to CS 1660)	36
7.5	Service mode	37
7.5.1	Refrigerator/freezer compartment	37
7.5.2	IceMaker (Does apply to CS 1660)	38
7.5.3	solenoid valve	39
8.0	Error code, troubleshooting	40
8.1	Table of error codes	40

1.0 Operating and control elements

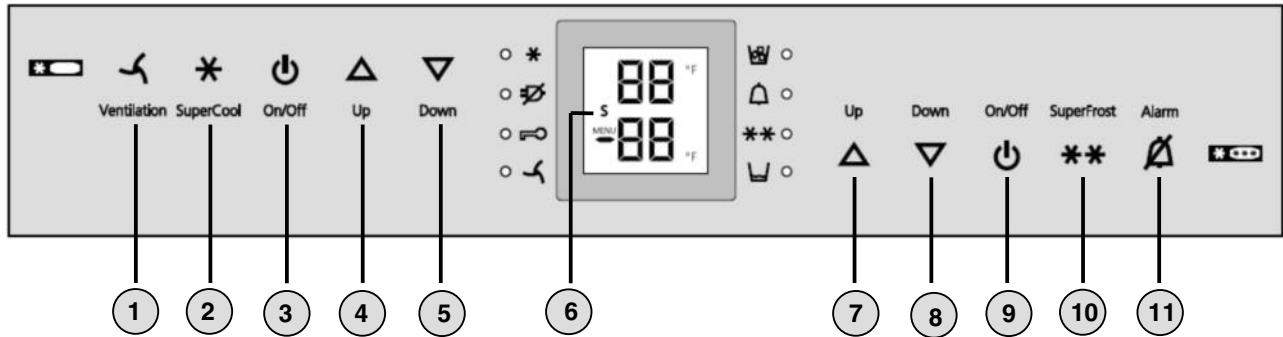

Symbol for
 symbol LED lit = function activated

-  Power failure
-  SuperCool
-  Child lock
-  Alarm
-  Icemaker
-  SuperFrost
-  Ventilation
-  Inactive Symbol

Refrigerator compartment		Freezer compartment	
3	ON/OFF ON/OFF button for refrigerator compartment	10	SuperFrost SuperFrost function
2	SuperCool SuperCool function	9	ON/OFF ON/OFF button for freezer compartment
4	Up Setting button temperature higher	7	Up Setting button temperature higher
5	Down Setting button temperature lower	8	Down Setting button temperature lower
1	Ventilation Fan function		
General			
11	Alarm Alarm OFF button for audible alarm		
6	Sabbath mode Active Sabbath mode		

2.0 Functions at a glance

Control:	Electronic	
Temperature display:	Refrigerator compartment: Freezer compartment:	Actual value Actual value
Temperature range:	Refrigerator compartment: Freezer compartment:	36°F to 44°F 6°F to -15°F
Temperature alarm:	Refrigerator compartment: Freezer compartment:	Not present Visual, audible
Door alarm:	Refrigerator compartment: Freezer compartment:	Audible Audible
Fan:	Refrigerator compartment: Freezer compartment:	Present Present
Defrosting:	Refrigerator compartment: Freezer compartment:	Automatic Automatic
Interior light:	Refrigerator compartment: Freezer compartment:	Present Not present Present (CS 1660)
Service menu:	Present	
Compressor:	2x VCC	
Solenoid valve refrigeration circuit:	Not present	

3.0 Description of the appliance

The **CS 14../ CS 16..** is a combined refrigerator-freezer with NoFrost freezer compartment. The appliance has two compressors.

The **CS 1660** has an water filter in the refrigerator and an Icemaker in the NoFrost freezer compartment.

The refrigerator compartment has a freely suspended rear wall evaporator. The temperature is controlled using an evaporator sensor and an air sensor.

The freezer compartment has a lamellar evaporator with integrated defrost heater and fan. Two sensors, an air sensor and an evaporator sensor, see to the control and automatic defrosting. A safety temperature limiter protects the appliance against excessively high temperatures during the defrosting phase.

3.1 Sensor positions, schematic diagrams

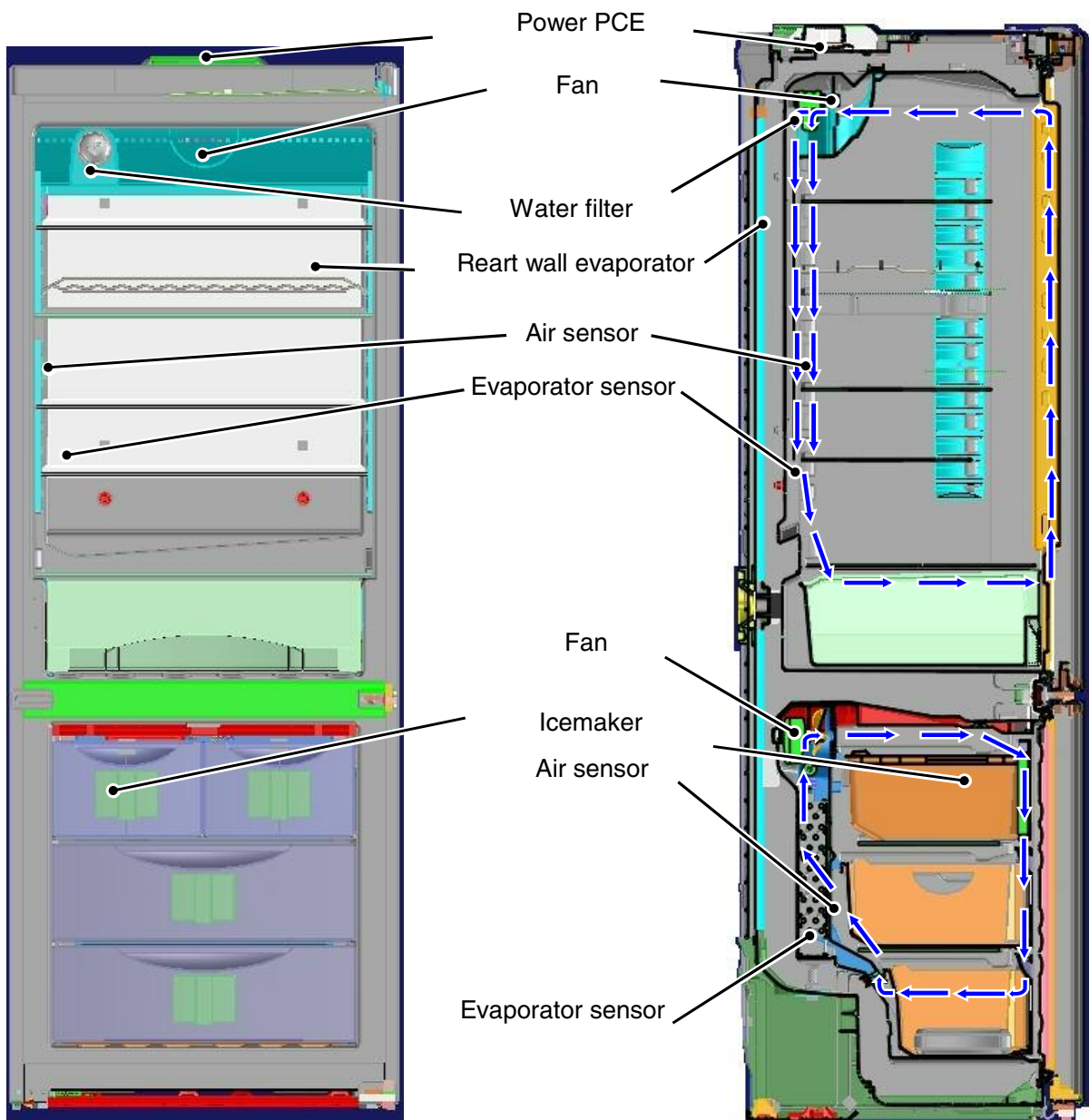

Fig. 3.1/ 1

Fig. 3.1/ 2

4.0 Main components and their functions

4.1 Electrical components and functions

4.1.1 General

Electronics	
Type:	Series 6 electronic control system
Components:	Control panel and power PCB

4.1.2 Refrigerator compartment

Electronics	
Setting range:	Refrigerator compartment: 36°F to 44°F
Display range:	36°F to 99°F (actual value display) Temperatures equal to and lower than 36°F are displayed with 36°F.
Functions	
SuperCool:	ON: - Refrigerator compartment sets itself to 36°F for 6 hours. - Fan ON.
	OFF: The refrigerator compartment sets itself to the set value.
Ventilation:	ON: Fan runs in parallel with refrigerator compartment compressor.
	OFF: Fan is OFF. (<u>Exception:</u> SuperCool function activated). During start-up the fan is activated only from an evaporator sensor temperature of 54°F and colder.
Defrosting:	Automatic during compressor standstill phase.
Door alarm:	When: If door is open, after 180 seconds.
	Audible: 3 beeps.
Sensors	
Refrigerator compartment air sensor:	Position: In the centre, on the inside left.
	Function: - Switches the compressor OFF - Generates the display value.
Evaporator sensor:	Position: On the back of the freely suspended evaporator.
	Function: - Switches the compressor ON - Ends the defrosting phase.

Switch

Door switch: Position: In the door panel at the top.
 Type: Reed PCB
 Contact type: Make contact
 Function: **Activation via:**
 Magnet behind front panel, magnet is replaceable.
Switching signal when:
door closed: fan ON
 interior light OFF
door open: fan OFF
 interior light ON
 door alarm ON after 180 seconds

Loads

Fan: Position: In the centre beneath the compartment liner ceiling.
 Function:

Ventilation	Compressor	Door	Fan
ON	ON	CLOSED	ON
ON	OFF	CLOSED	OFF
OFF	ON/OFF	CLOSED /OPEN	OFF
ON/OFF	ON/OFF	OPEN	OFF

During start-up the fan is activated only from an evaporator sensor temperature of 54°F and colder.

Refrigerator compartment interior light: Position: Ceiling.
 Function: - Shines as soon as the door is opened.
 - Is switched OFF after door has been open for 15 minutes.

Compressor: Type: Standard
 Function: ON: Refrigerator compartment evaporator sensor switch-on value
Note: On-delay time (8 minutes) must have elapsed.
 OFF: Refrigerator compartment air sensor switch-off value

4.1.3 Freezer compartment

Electronics	
Setting range:	6°F to -15°F
Display range:	32°F to -58°F (actual value display) Temperatures equal to and lower than -58°F are displayed with -58°F. Temperatures equal to and higher than 32°F are displayed with an crossbar.
Functions	
Temperature alarm:	<p>Alarm value: 4K warmer than set value. SuperFrost alarm value: 0°F. Delay: 60 min. Visual: Flashing temperature display. Audible: 4 beeps.</p> <p>During start-up: The temperature display flashes until the switch-off value is reached, the audible alarm is switched OFF.</p> <p>(for example with a set value of 0°F, there must be a temperature of 6°F for at least 60 mins., then a temperature alarm is issued.)</p> <p>When the defrosting phase begins, the temperature alarm is suppressed for 1.5 hrs.</p>
Defrosting:	<p>ON: - During start-up after 6 hours cumulative compressor running time. - After a cumulative compressor running time of 12 to 24 hours maximum, depending on the number/duration of the door openings.</p> <p>When the defrosting phase begins, the compressor and the fan are switched OFF and the defrost heater is switched ON.</p> <p>Duration: The defrost heater remains switched ON until - the freezer compartment evaporator sensor has reached 41°F or - a max. defrosting time of 50 minutes has been reached.</p> <p>Info: After the end of the heating phase the compressor is switched ON with a 10-minute delay. If the SuperFrost function is activated during the defrosting phase, this will not interrupt defrosting.</p>
Door alarm:	<p>When: If door is open, after 180 seconds. Audible: 3 beeps.</p>
SuperFrost:	<p>ON: Freezer compartment sets itself to -40°F (quantity-controlled, min. 30 hrs., max. 65 hrs.)</p> <p>The appliance sets itself to -40°F for at least 30 hours. In the following 35 hours cooling by 8K to the set value must have been reached or a total time of 65 hours must have elapsed in order that SuperFrost is automatically ended.</p> <p>OFF: The freezer compartment sets itself to the set value.</p> <p>Note: If SuperFrost is actuated during a defrosting phase, the SuperFrost function is not performed before the defrosting phase has run.</p>

Sensors

Air sensor: Position: Clipped into the sensor holder in the air duct panel.
Function: - Switches the compressor ON and OFF.
- Generates the display value.

Evaporator sensor: Position: Slipped into lamellar evaporator.
Function: - Switches the freezer compartment fan ON.
- Ends the defrosting phase.

Switch

Door switch: Position: In fan casing.
Type: Reed PCB
Contact type: Make contact
Function: **Activation via:**
Magnet on the door interior, magnet is replaceable.
Switching signal when:

door closed:	fan	ON
door open:	fan	OFF
	door alarm	ON after 180 seconds

Loads

Fan: Position: Top centre of freezer compartment.
Function: **ON:** - compressor ON **and**
- freezer compartment door closed **and**
- evaporator sensor switch-on value reached.
Switch-on value evaporator sensor:
a) during start-up / after defrosting phase: 0°F.
b) In normal mode: As cold as or colder than air sensor.
OFF: - Compressor OFF

Defrost heater: Position: Clipped into lamellar evaporator.
Function: Keeps the lamellar evaporator free from ice.
For activation, see: **Functions Defrosting**

Compressor: Type: Standard
Function: ON: Freezer compartment air sensor switch-on value
Note: On-delay time (8 minutes) must have elapsed.
OFF: Freezer compartment air sensor switch-off value

Freezer compartment interior light: Position: At the bottom side of the refrigerator compartment door.
Function: - Shines as soon as the door is opened.
- Is switched OFF after door has been open for 15 minutes.

4.2 Refrigeration components and functions

4.2.1 Refrigerator compartment

Compressor	
Design	VCC
Evaporator	
Type:	Rear wall evaporator
Type of installation:	Suspended freely.
Injection point:	At the top left
Flow sequence:	Top to bottom

4.2.2 Freezer compartment

Compressor	
Design	VCC
Evaporator	
Type:	Lamellar evaporator
Type of installation:	Freestanding between air duct panel and compartment liner.
Injection point:	Top left on lamellar evaporator.
Flow sequence:	From the top down and then up again.

5.0 Assembly instructions / replacement of parts

5.1 General

5.1.1 Electronic control panel

Covers: - Disengage the covers at the marked locations.



Fig. 5.1.1 / 1



Fig. 5.1.1 / 1

PCB carrier: - Disengage and remove bus connector.

Note: - Front panel is replaceable only as a unit, control PCB and reed PCBs are not separately available!

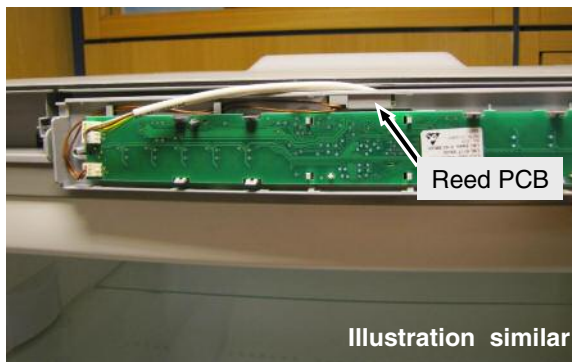

Fig. 5.1.1 / 2

5.1.2 Power electronics

Note: Pull out the mains plug!

Electronic power module cover:

- Undo screws.
- Raise the cover and remove it.



Fig. 5.1.2 / 1

PCB cover:

- Disconnect cables.
- Unclip the cover.



Fig. 5.1.2 / 2

- Power electronics:**
- Unclip the PCB.
 - To make matters easier, one can unclip the entire PCB carrier beforehand.

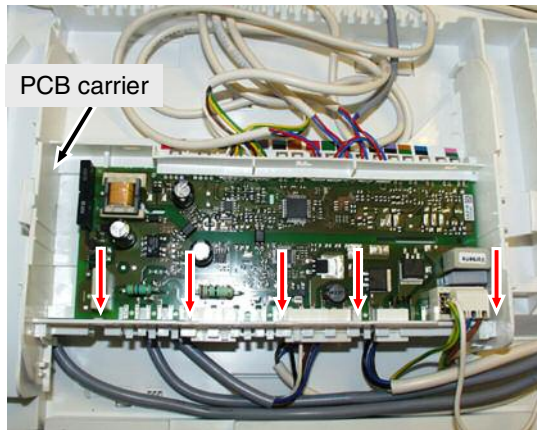

Fig. 5.1.2 / 3

- Cable routing:**
- Route all the cables in the guides provided in order that the cover can be fitted properly.



Fig. 5.1.2 / 4

5.1.3 Top door hinge

Turn hinge cover: Disengage the cover in the direction marked and lift it off.

Door turn hinge:

- Undo the marked screws and remove the door turn hinge.
- Put the door turn hinge in the position shown so that the location holes for the template are in a line.
- Insert the template.



Fig. 5.1.3/ 1

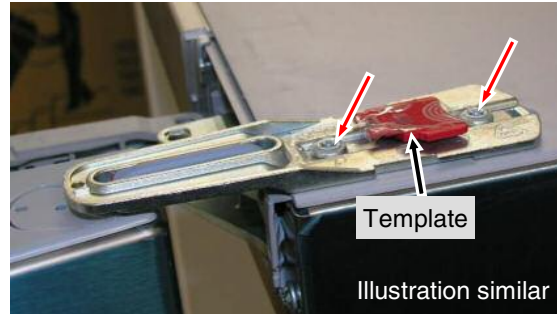

Fig. 5.1.3/ 2



Fig. 5.1.3 / 3

Changing the door hinges: Remove the cover on the opposite side and insert the turn hinge and screw it down.

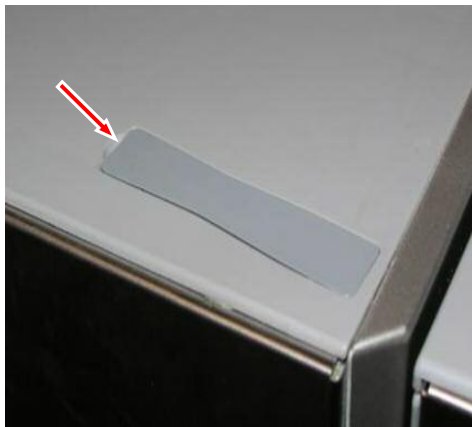

Fig. 5.1.3/ 4



Fig. 5.1.3/ 5

5.1.4 Bottom door hinge

Turn hinge cover: Disengage the cover in the direction marked and draw it forwards for removal.

Bearing pin:

- Retract the height-adjustable foot and press down the bearing pin. Then swing out the door at the bottom and draw it out of the upper bearing pin.
- Notch has to point forwards for re-fitting.

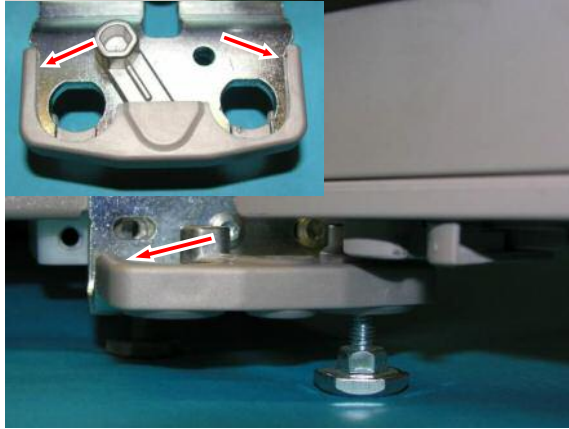

Fig. 5.1.4/ 1 Turn hinge cover

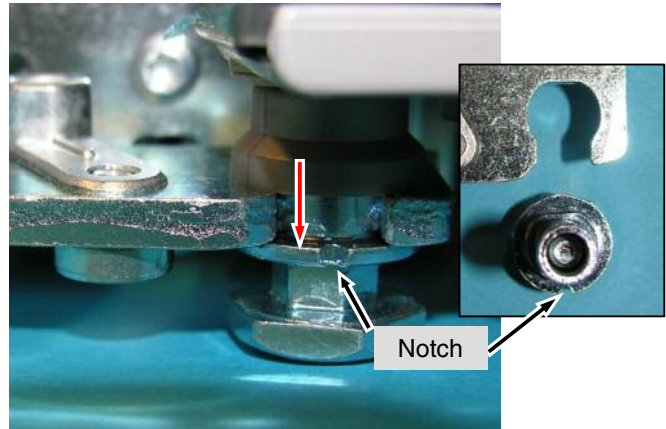

Fig. 5.1.4/ 2 Bearing pin

Changing the door hinges:

- Press in the holding clip and detach the spring clip. Has to be transferred to the opposite side when changing the door hinges.
- Lower bearing element has to be transferred when changing the door hinges.

Slot:

- If door adjustment is necessary, the middle screw can be removed.

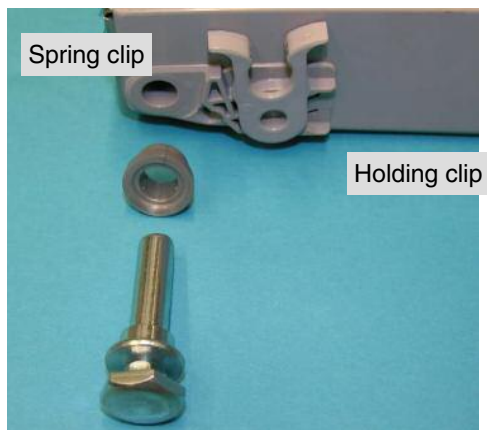

Fig. 5.1.4/ 3 Spring clip

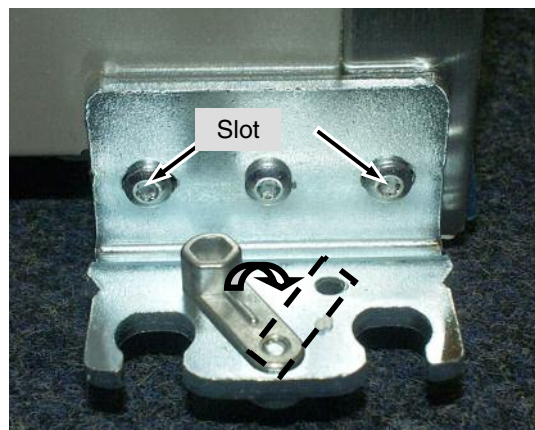

Fig. 5.1.4/ 4

5.2 Refrigerator compartment

5.2.1 Magnet and reed contact for door recognition

Covers: - Unclip the cover at the marked points and slide it outwards.



Fig. 5.2.1 / 1

Reed PCB:

- Reed PCB is directly connected at the Control Panel PCB.
- With the exchange of the Reed PCB you also must change the control panel PCB. **(Reed PCB separately not available!)**



Fig. 5.2.1/ 2 Front panel

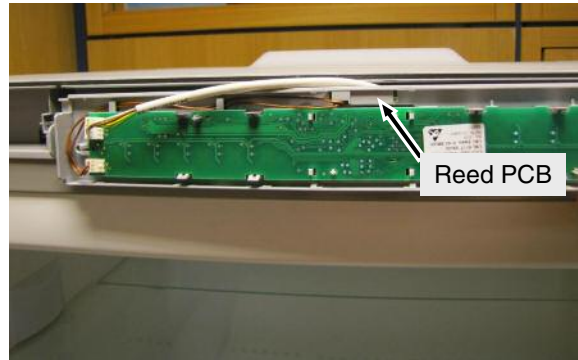

Fig. 5.2.1/ 3 Reed PCB

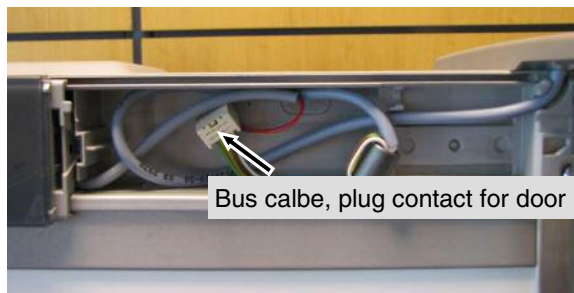

Fig. 5.2.1/ 3 Front without cover

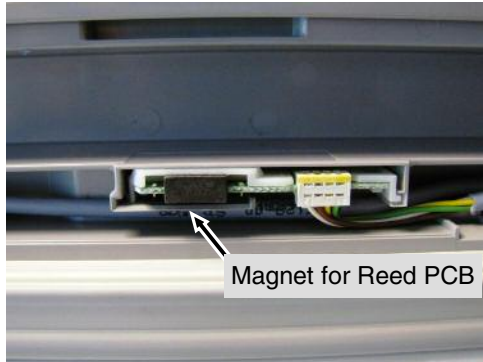

Fig. 5.2.1/ 4 Cover of door extension

Magnet: - Magnet is clipped on the PCB for the freexer compartment light.



Fig. 5.2.1/ 5 Door extension without cover



Magnet for Reed PCB

Fig. 5.2.1/ 6

5.2.2 Cable feedthrough in door

- Detach bus connector from the reed PCB.
- Lever out the cable feedthrough using a screwdriver.
- In case of door hinge changeover: Transfer bus cable feedthrough.

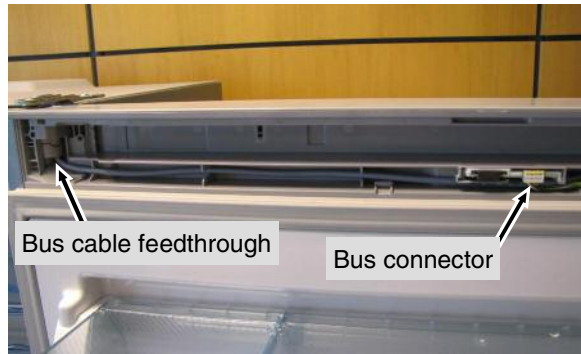

Fig. 5.2.2 / 1

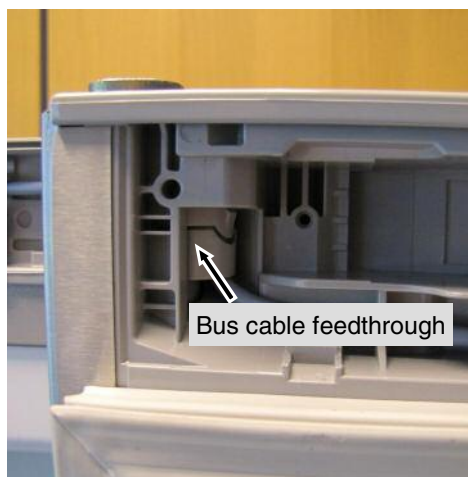

Fig. 5.2.2 / 2

5.2.3 Air sensor

- Fan cover:**
- Remove stoppers.
 - Undo the screws and lower the cover.

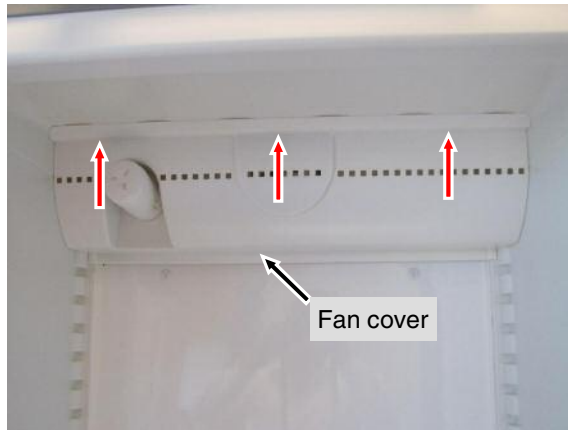

Fig. 5.2.3/ 1



Fig. 5.2.3/ 2

- Sensor:**
- Remove the stopper and unscrew the cover.



Fig. 5.2.3 / 3



Fig. 5.2.3 / 4

- Sensor cable:**
- Undo the bayonet screws and swing the evaporator to the left.
 - Pull the air sensor out rearwardly through the housing feedthrough and replace it by the repair kit. The repair instructions accompany the repair kit.

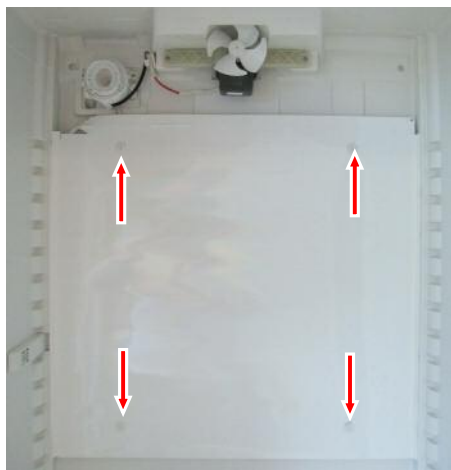

Fig. 5.2.3/ 5

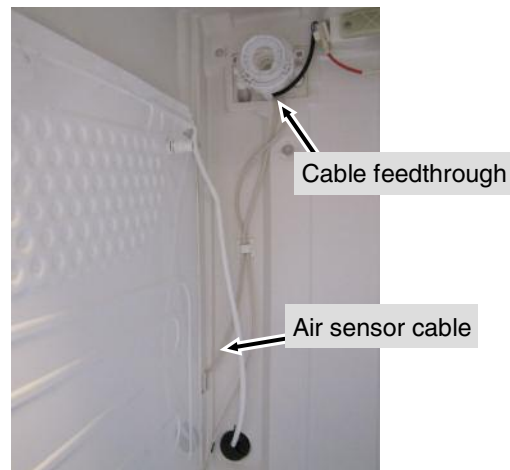

Fig. 5.2.3/ 6

5.2.4 Evaporator sensor

Sensor:

- Draw the sensor out of the holder, thread it through the rear wall and assemble it with a universal sensor.



Fig. 5.2.4/ 1

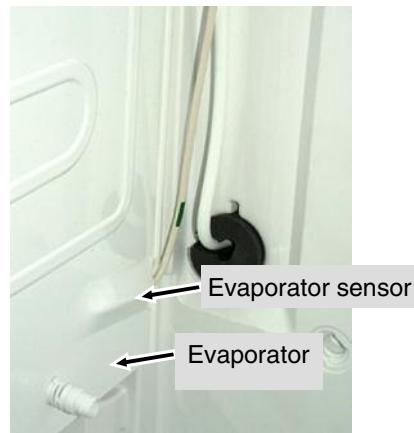

Fig. 5.2.4/ 2

5.2.5 Fan

Fan:

- Remove fastening screws of the fan mount.
- Detach connecting cable.

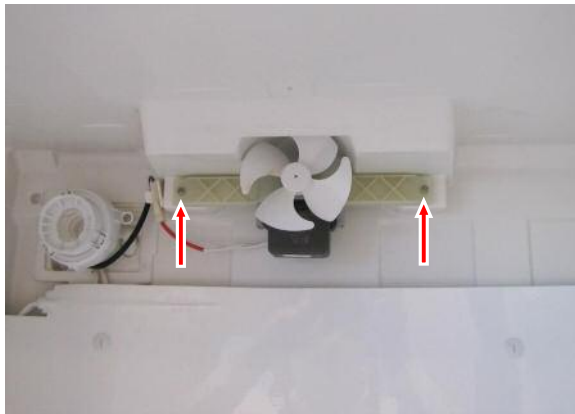

Fig. 5.2.5 / 1

5.2.6 Replacement of the base of the water filter (CS 1660)

Base of the water filter:

- The base is mounted on the appliance's back wall behind the evaporator cover.
- Remove the compound mastic at the rear side of the back wall and cut off the water hoses.



Fig. 5.2.6/ 1

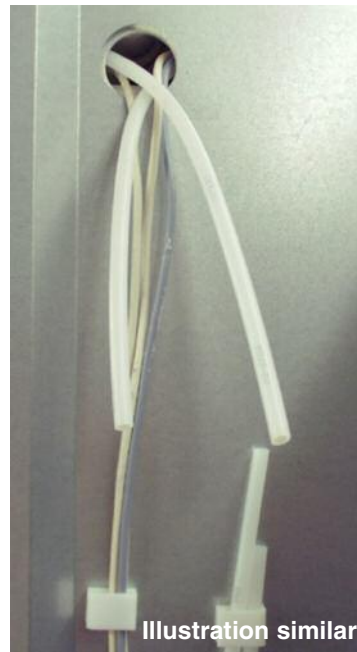

Fig. 5.2.6/ 2

Connection of the water hoses:

- Push the ends of the connectors deep into the connectors (17mm – make a mark).

ATTENTION: Connect the correct ends. The water must be lead in the correct direction through the filter.

- Check the correct fitting and secure each connection with the red ring
- Put the hoses in their original position and test the system on any leakages (e.g. with the service mode of the IceMaker)

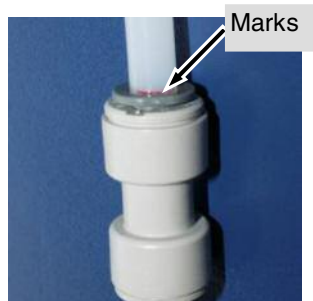

Fig. 5.2.6/ 4

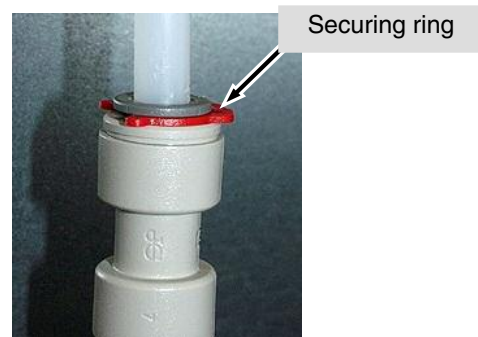

Fig. 5.2.6/ 5

5.2.7 Lighting (CS 1611, CS 1400)

- Unlock and remove faceplate for ceiling light.

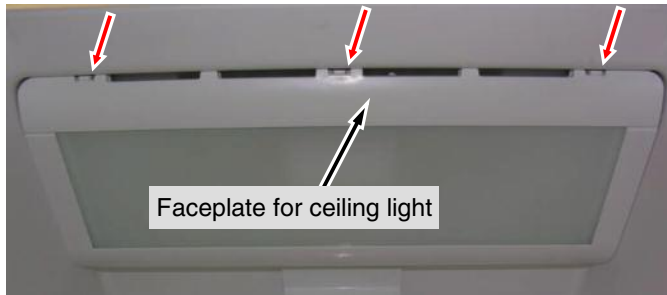

Fig. 5.2.7 / 1

- Pull out glass plate in a forward direction.



Fig. 5.2.7 / 2

- Undo fastening screws.



Fig. 5.2.7 / 3

- Fold down the light housing.



Fig. 5.2.7 / 4

- Disengage the reflector plate.
- **Info:** The reflector plate holds the lampholder cover.



Fig. 5.2.7 / 5

- Remove lampholder cover



Fig. 5.2.7 / 6



Fig. 5.2.7 / 7

5.2.8 Lighting (CS 1660)

LED light column:

- Using a small screwdriver, turn the slot in the cap downwards.
- Insert a screwdriver in the slot and remove the cap.
- Undo screws of light column.

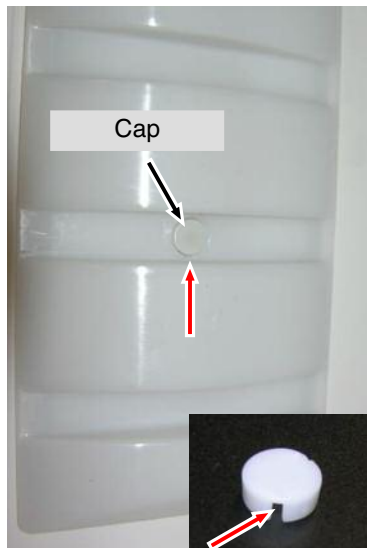

Fig. 5.2.8 / 1

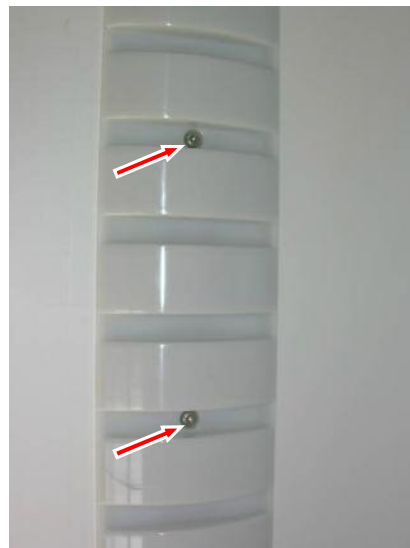

Fig. 5.2.8 / 2

LED PCB:

- Unlock and pull off connector (**Fig. 5.2.8/ 3**).
- Unlock PCB and connector socket at the marked locations (**Fig. 5.2.8/ 4**).
- Lift PCB at an angle from the light cover.

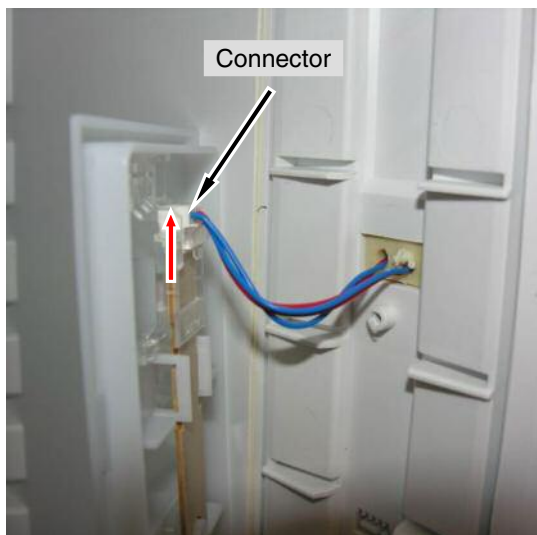

Fig. 5.2.8 / 3

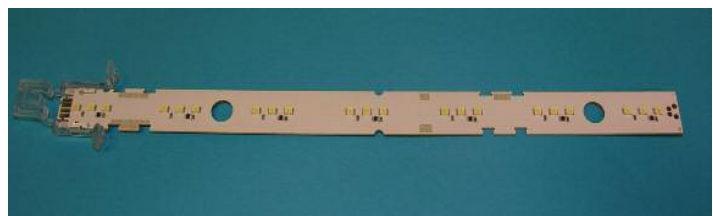
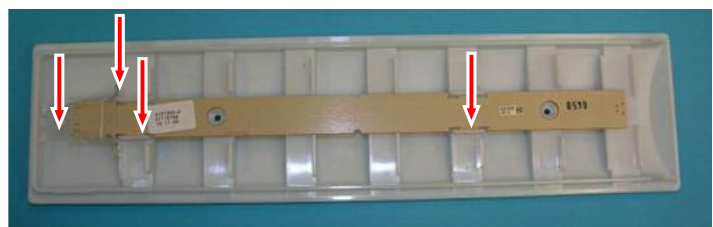

Fig. 5.2.8 / 4

INFO

One LED group comprising 3 LEDs is used for each illuminated support rib. If a single LED of an LED group is defective, the entire LED group is inoperative. All the other LEDs continue to shine.

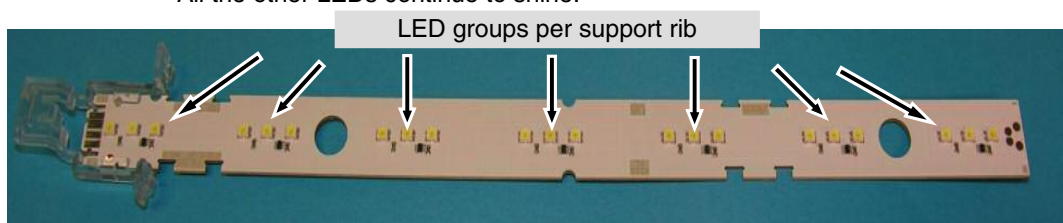

Fig. 5.2.8 / 5

5.3 Freezer compartment

5.3.1 Air sensor, evaporator module and fan module

Air sensor: Engaged in sensor holder on air duct panel.

Evaporator module:

- Clear the drawers and glass shelves in the freezer compartment.
- Disengage the air sensor.
- Undo the screws marked in **Fig. 5.3.1/ 1** and remove the air duct panel.
- Raise and swing out the evaporator module in a forward direction.

Fan module: Undo the marked screws and expose the cable (**see Fig. 5.3.1/ 3**).

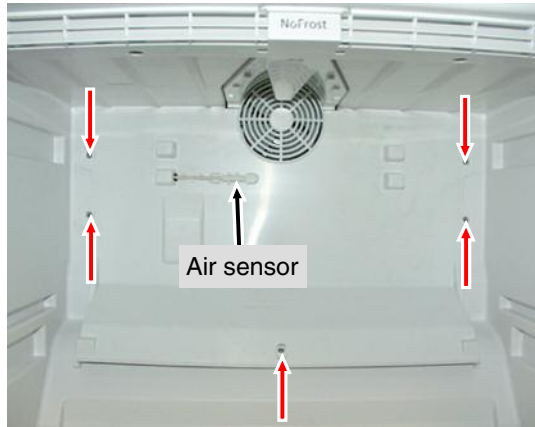

Fig. 5.3.1/ 1



Fig. 5.3.1/ 2

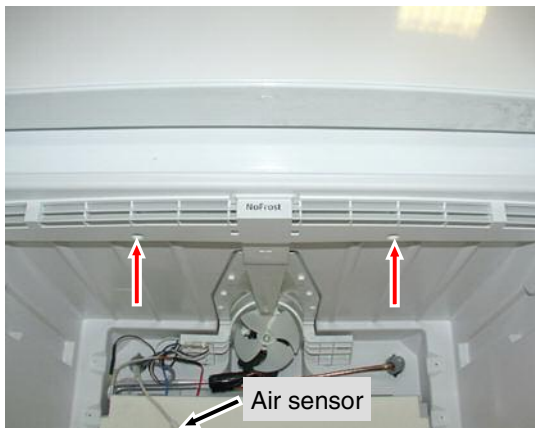

Fig. 5.3.1 / 3

5.3.2 Temperature fuse, evaporator sensor and defrost heater

- Temperature fuse:**
- Feel for position of temperature fuse.
 - Make an incision in the sheeting.
 - Undo screw.

The temperature fuse has to be replaced separately using a conversion kit.

- The conversion kit comprises:
- 1 temperature fuse
 - 2 compression connectors
 - 2 shrink hoses

Note:

Always fit the compression connector to the red and blue lead of the temperature fuse. The defrost heater is destroyed as soon as the white lead of the defrost heater is cut.

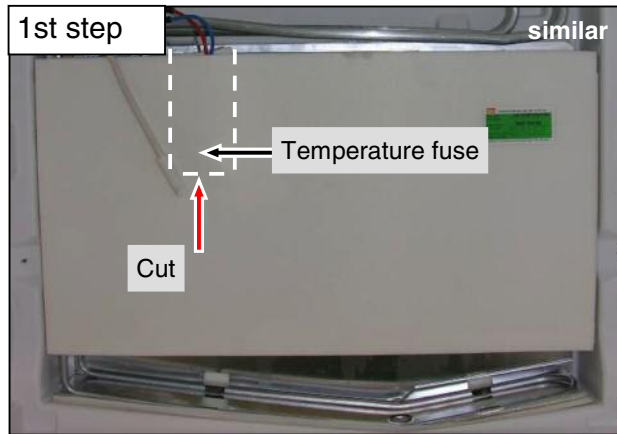

Fig. 5.3.2/ 1 Evaporator module

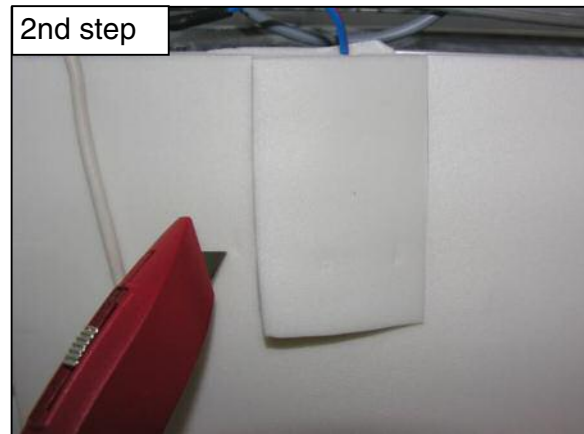

Fig. 5.3.2/ 2 Making an incision in the sheeting

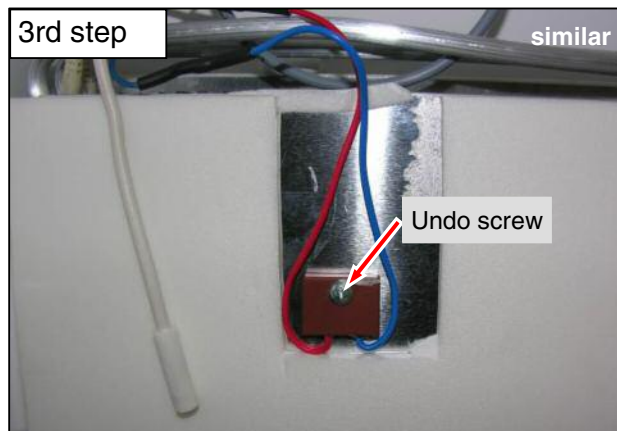

Fig. 5.3.2/ 3 Temperature fuse

Evaporator sensor: Raise evaporator module and swing it out in a forward direction .
 - Make an incision in the sheeting at the marked points.
 - Bend open the retaining lugs of the cover plate and remove it.
 - Draw the evaporator sensor to the left, out of the lamellar evaporator.

Defrost heater: Is clipped into the evaporator fins. Can be replaced if defective.

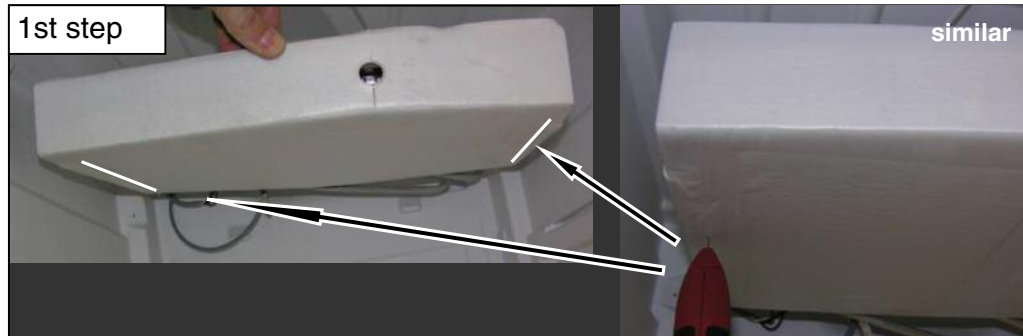

Fig. 5.3.2/ 4 Making an incision in the sheeting

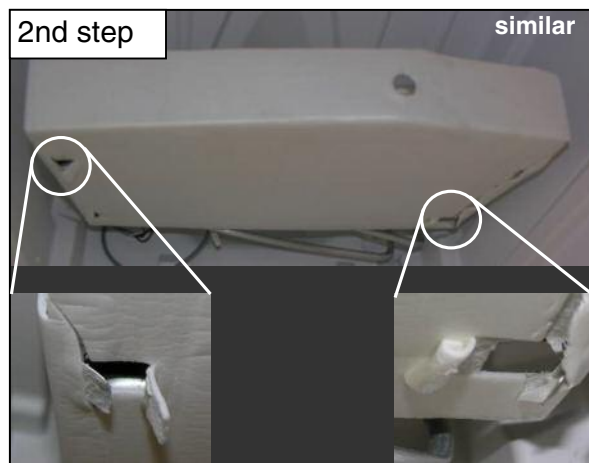

Fig. 5.3.2/ 5 Cutting open the evaporator cover

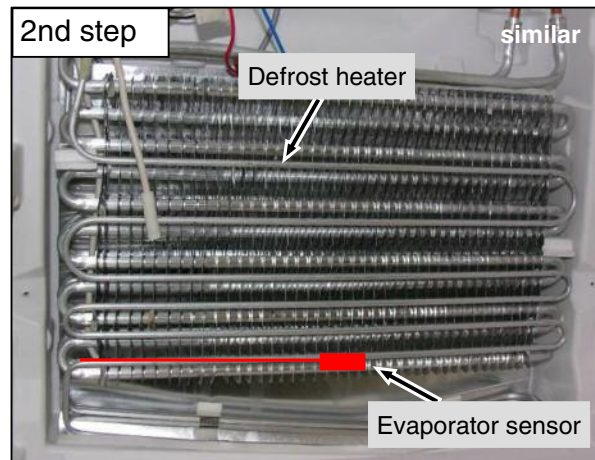

Fig. 5.3.2/ 6 Lamellar evaporator

5.3.3 Fan and reed PCB

Reed PCB:

- Release fan module.
- Disengage cover of the reed PCB.
- Disconnect reed PCB.
- Note the mounting direction of the reed PCB. Reed relay points forwards.

Fan:

- Disconnect reed PCB.
- Extract cable from the fan module.
- Disconnect fan cable.
- Remove fan module.
- Detach fan blades.
- Remove fan from holder.

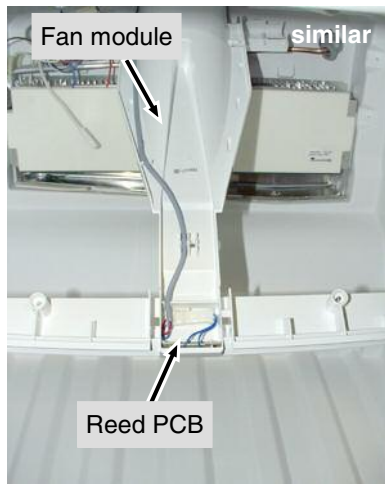

Fig. 5.3.3/ 1 Fan module with reed PCB

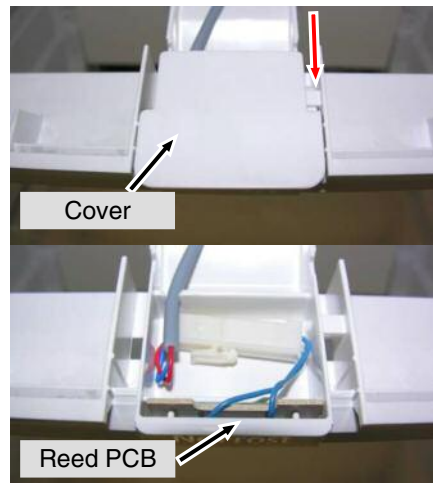

Fig. 5.3.3/ 2 Reed PCB

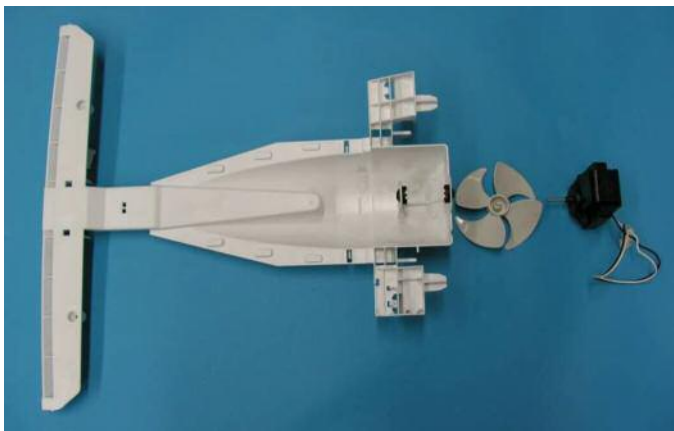

Fig. 5.3.3/ 3 Fan

5.3.4 Automatic IceMaker (CS 1660)

- Disengage the automatic IceMaker and draw it forwards for removal (see **Fig. 5.3.4/ 1**).



Fig. 5.3.4 / 1 Fan

- Detach connector (see **Fig. 5.3.4/ 2**).



Fig. 5.3.4/ 2 Connector contact

5.3.5 Lighting (CS 1660)

Freezer compartment lighting

- Undo the screws (see 1st step, **Fig. 5.3.5/ 1**)
- Disconnect the cable and unclip the strip (see **Fig. 5.3.2/ 2**)

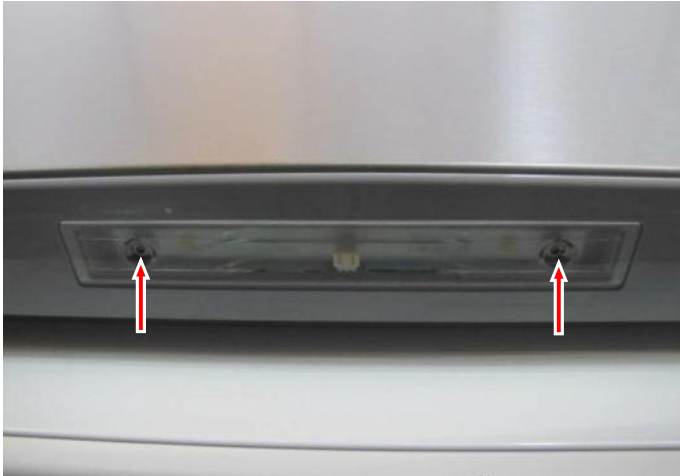

Fig. 5.3.5 / 1



Fig. 5.3.5 / 2

6.0 Technical data

6.1 General

Sensor values: Refrigerator compartment: Air and evaporator sensors
Freezer compartment: Air and evaporator sensors

Temperature °F	Resistance value kOhm
+95	3.1
+86	3.8
+77	4.7
+68	5.9
+59	7.3
+50	9.3
+41	11.9
+32	15.3
+23	19.8
+14	25.9
+5	34.1
-4	45.3
-13	60.8
-22	82.3
-31	112.8

6.2 Refrigerator compartment

Interior light: Wattage: 2 x 25 Watt (CS 1400) LED 25 Watt (CS 16..)
Voltage: 115 Volt
Socket: E14

Fan: Wattage: 1,1 Watt
Voltage: 115 V/AC (60Hz)
Speed: 1500 rpm
Direction of rotation: left (viewed from the front onto the fitted fan)

6.3 Freezer compartment

Fan: Wattage: 1,5 Watt
Voltage: 115 Volt
Speed: 2100 rpm

Defrost heater: Wattage:
CS 1400: 138 Watt
CS 16..: 193 Watt
Voltage: 115 Volt

Temperature fuse: Tripping temperature: 183°F (Is faulty after tripping and has to be replaced)

7.0 Service menu

The service menu may be used by service technicians only.

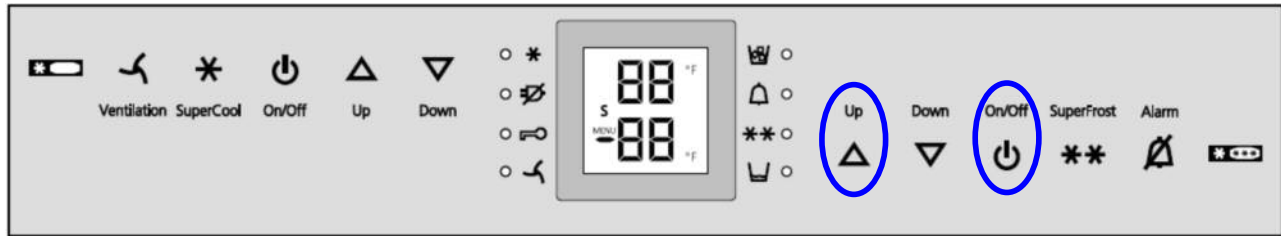











Activation of service menu: Press "Up" + "ON/OFF" simultaneously for about 5 seconds (freezer compartment buttons)

If the **service menu is activated**, then "MENU" flashes in the display.

7.1 Manual defrosting

Step	Display	Operation	Display following operation	Testing option / Info
Service menu start --manual defrosting--				SF = SuperFrost
1	Actual value	Press "Up" and "ON/OFF" simultaneously for 5 seconds	H flashes	Service menu active, Manual defrosting selected
2	H flashes	Press "SF" once	H I Static	Manual defrosting ON selected
3	H I Static	Press "SF" once	R Static	Manual defrosting ON activated
Manual defrosting is ended by: - Switching appliance OFF/ON - Automatic after the defrost parameters are reached				

7.2 Demo mode

Step	Display	Operation	Display following operation	Testing option / Info
Start service menu -- Demo mode ON --				SF = SuperFrost
1	Actual value	Press "Up" and "ON/OFF" simultaneously for 5 seconds	 flashes	Service menu active
2	 flashes	Press "Up" once	 flashes	Demo mode selected
3	 flashes	Press "SF" once	 Static	Demo mode ON selected
4	 Static	Press "SF" once	Set value and " Demo "	Demo mode ON
Start service menu -- Demo mode OFF--				SF = SuperFrost
1	Actual value	Press "Up" and "ON/OFF" simultaneously for 5 seconds	 flashes	Service menu active
2	 flashes	Press "SF" once	 static	Demo mode OFF selected
3	 static	Press "SF" once	Actual value	Demo mode OFF
<p>The text "Demo" in the display informs of the activated demo mode. Demo mode can be deactivated only via service menu, not by OFF/ON or disconnection from the supply. Operation switches to the mode wanted, demo mode or normal mode, as soon as "SuperFrost" has been actuated.</p>				

7.3 Panel test



Step	Display	Operation	Display following operation	Testing option / Info
Service menu start				SF = SuperFrost
1	Actual value	Press "Up" and "ON/OFF" simultaneously for 5 seconds	H flashes	Service menu active
Panel test -- test of sensor buttons, display elements, door sensor and beep --				
2	H flashes	Press "Up" twice	P flashes	Panel test selected
3	P flashes	Press "SF" once	P I Static	Panel test activated
4	P I Static	Press "SF" once	All symbols/segments	Display elements/ More symbols are displayed than the respective electronic control system uses!
5	All symbols/segments	Door open/closed and press all buttons one after the other (each operation is confirmed by beep)	- Beep for 2 sec. - appliance switches OFF	After the last button has been pressed a beep sounds for 2 seconds, only if the test has been successful.
End	Panel test cannot be ended in step 2, for example, it has to be performed in full. Should a button/reed contact be defective, no 2-second beep sounds and the appliance does not switch OFF . The appliance then has to be unplugged and plugged back in again.			

7.4 Sensor test (display of temperature) and door contact test **E-**

7.4.1 Refrigerator/freezer compartment **E'**

Step	Display	Operation	Display following operation	Testing option / Info
Service menu start				SF = SuperFrost
1	Actual value	Press "Up" and "ON/OFF" simultaneously for 5 seconds	H flashes	Service menu active
Sensor test and door contact test (sensor values without offset, appliance in control mode)				
2	H flashes	Press "Up" three times	E- flashes	Sensor test mode selected
3	E- flashes	Press "SF" once	E' Static	Sensor test mode refrigerator/freezer compartment activated
9 → 4	E' Static	Press "SF" once	'3 flashes alternately with sensor temperature	Freezer compartment air sensor
5	'3 flashes alternately with sensor temperature	Press "Up" once	'4 flashes alternately with sensor temperature	Freezer compartment evaporator sensor
6	'4 flashes alternately with sensor temperature	Press "Up" once	'1 flashes alternately with sensor temperature	Refrigerator compartment air sensor
7	'1 flashes alternately with sensor temperature	Press "Up" once	'2 flashes alternately with sensor temperature	Refrigerator compartment evaporator sensor
8	'2 flashes alternately with sensor temperature	Press "Up" once	'A flashes alternately with oP or cL	Refrigerator compartment door contact (oP=door open, cL=door closed)
4 ← 9	'A flashes alternately with oP or cL	Press "Up" once	'B flashes alternately with oP or cL	Freezer compartment door contact (oP =door open, cL =door closed)
End	Press "ON/OFF" once: Press "ON/OFF" twice: Press "ON/OFF" three times:	Return to level 2 E' . Return to level 1 E- . Return to normal/control mode	No further points selectable with this appliance. Points: d , P , E- , L selectable	

7.4.2 Automatic IceMaker **E8** (Does apply to CS 1660)

Step	Display	Operation	Display following operation	Testing option / Info
Service menu start				SF = SuperFrost
1	Actual value	Press "Up" and "ON/OFF" simultaneously for 5 seconds	H blink	Service menu active
Sensor test and door contact test (sensor values without offset, appliance in control mode)				
2	H flashes	Press „Up“ three times	E- flashes	Sensor test mode selected
3	E- flashes	Press „SF“ once	E8 static	Sensor test mode activated
4	E8 static	Press „Up“ once	E8 static	IceMaker selected
6 → 5	E8 static	Press „SF“ once	88 flashes alternately with sensor temperature	IceMaker air sensor
5 ← 6	88 flashes alternately with sensor temperature	Press „Up“ once	8A flashes alternately with oP or cL	Ice cube drawer door contact (oP=door open, cL=door closed)
End	Press "ON/OFF" once: Return to level 2 E8 . No further points selectable with this appliance. Press "ON/OFF" twice: Return to level 1 E- . Points: d , P , E- , L selectable Press "ON/OFF" three times: Return to normal/control mode			

7.5 Service mode











































7.5.1 Refrigerator/freezer compartment

Step	Display	Operation	Display following operation	Testing option / Info	
Service menu start					SF = SuperFrost
1	Actual value	Press "Up" and "ON/OFF" simultaneously for 5 seconds	H flashes	Service menu active	
Service mode -- testing electric loads--					Power input 1)
2	H flashes	Press "Up" four times	L flashes	Service mode selected	
3	L flashes	Press "SF" once	L8 Static	Service mode activated	
10 → 4	L8 Static	Press "SF" once	80 Static	All OFF	--
5	80 Static	Press "Up" once	81 Static	Compressor freezer compartment ON	--
6	81 Static	Press "Up" once	82 Static	Compressor refrigerator compartment ON	--
7	82 Static	Press "Up" once	83 Static	Freezer compartment fan ON	7 watts
8	83 Static	Press "Up" once	84 Static	Freezer compartment defrost heater ON	CN 46: 137W CN 51: 193W
9	84 Static	Press "Up" once	85 Static	Light ON	50 watts
10	85 Static	Press "Up" once	87 Static	Refrigerator compartment fan ON	9 watts
4 ← 11	87 Static	Press "Up" once	8E Static	Freezer compartment light ON 2)	7 watts
End	Press "ON/OFF" once: Return to level 2 : L . No further points selectable with this appliance. Press "ON/OFF" twice: Return to normal/control mode				

























1) **Power input** = power input of the appliance in the respective testing step!

2) Point **'E** is only at CS 1660 selectable!

7.5.2 IceMaker  (Does apply to CS 1660)

Step	Display	Operation	Display following operation	Testing option / Info
Service menu start				SF = SuperFrost
1	Actual value	Press "Up" and "ON/OFF" simultaneously for 5 seconds	 flashes	Service menu active
Service mode -- testing electric loads--				
2	 flashes	Press "Up" four times	 flashes	Service mode selected
3	 flashes	Press "SF" once	 Static	Service mode activated
4	 Static	Press "Up" once	 Static	IceMaker selected
5	 Static	Press "SF" once	 static	All OFF
12 → 6	 Static	Press "Up" once	 flashes alternately with 	All OFF
7	 flashes alternately with 	Press "SF" once	 flashes alternately with 	- Ice-cube tray emptied, back to home position - 3 seconds solenoid valve ON
8	 flashes alternately with 	Press IceMaker ON/OFF button	 flashes alternately with 	All OFF
9	 flashes alternately with 	Press "Up" once	 flashes alternately with 	All OFF
10	 flashes alternately with 	Press "SF" once	 flashes alternately with  → 	- Ice-cube tray emptied - 25 seconds solenoid valve ON After 25 seconds have elapsed,  again flashes alternately with  The drawer must be closed.
11	 flashes alternately with 	- Press IceMaker ON/OFF button (→ switch ON) - Close drawer	 flashes alternately with 	Ice-cube tray returns to home position
6 ← 12	 flashes alternately with 	Press "Up" once	 Static	Return to step 6
End	Press "ON/OFF" once: Return to level 2  Items:    selectable Press "ON/OFF" twice: Return to normal/control mode			

7.5.3 solenoid valve

Step	Display	Operation	Display following operation	Testing option / Info
Service menu start				SF = SuperFrost
1	Actual value	Press "Up" and "ON/OFF" simultaneously for 5 seconds	 flashes	Service menu active
Service mode -- testing electric loads--				
2	 flashes	Press "Up" four times	 flashes	Service mode selected
3	 flashes	Press "SF" once	 Static	Service mode activated
4	 Static	Press "Up" two times	 Static	Solenoid valve selected
5	 Static	Press "SF" once	 static	All OFF
8 → 6	 Static	Press "Up" once	 flashes alternately with 	All OFF
7	 flashes alternately with 	Press "SF" once	 flashes alternately with 	- 10 seconds solenoid valve ON After 10 seconds have elapsed,  again flahes alternately with 
6 ← 8	 flashes alternately with 	Press "Up" once	 static	Return to step 6
End	Press "ON/OFF" once: Return to level 2  Items:    selectable Press "ON/OFF" twice: Return to normal/control mode			

8.0 Error code, troubleshooting

8.1 Table of error codes

Error code	Defective component	Emergency mode
F1	Refrigerator compartment air sensor	Compressor 10 minutes ON and 40 minutes OFF.
F2	Refrigerator compartment evaporator sensor	Compressor 10 minutes ON and 40 minutes OFF.
F3	Freezer compartment air sensor	Compressor continuous operation
F4	Freezer compartment evaporator sensor	Compressor continuous operation