

KRUPS

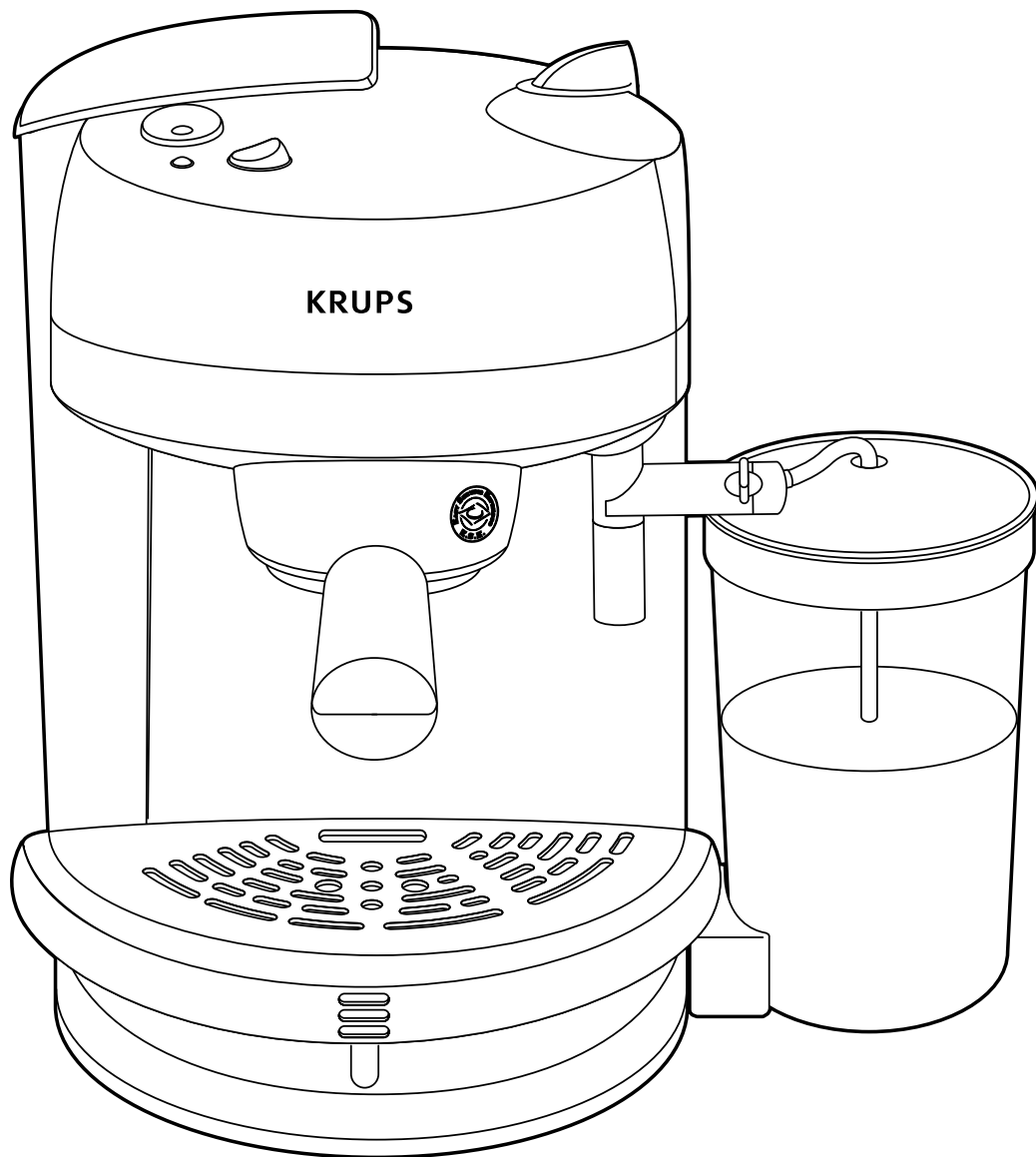

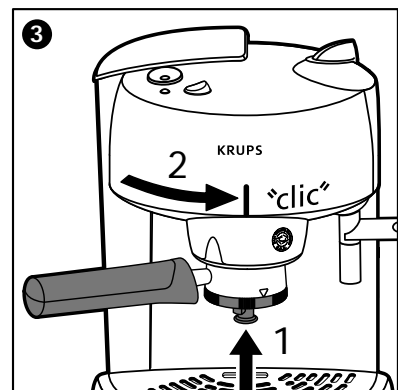

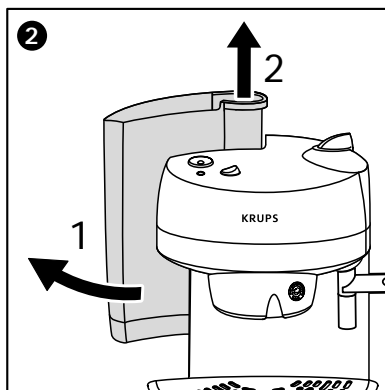
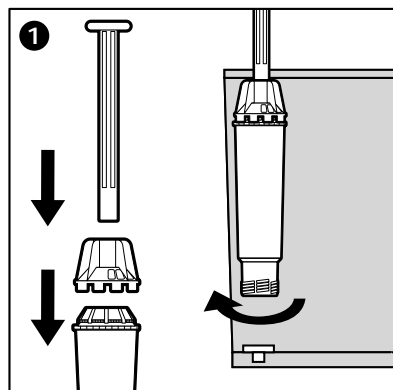
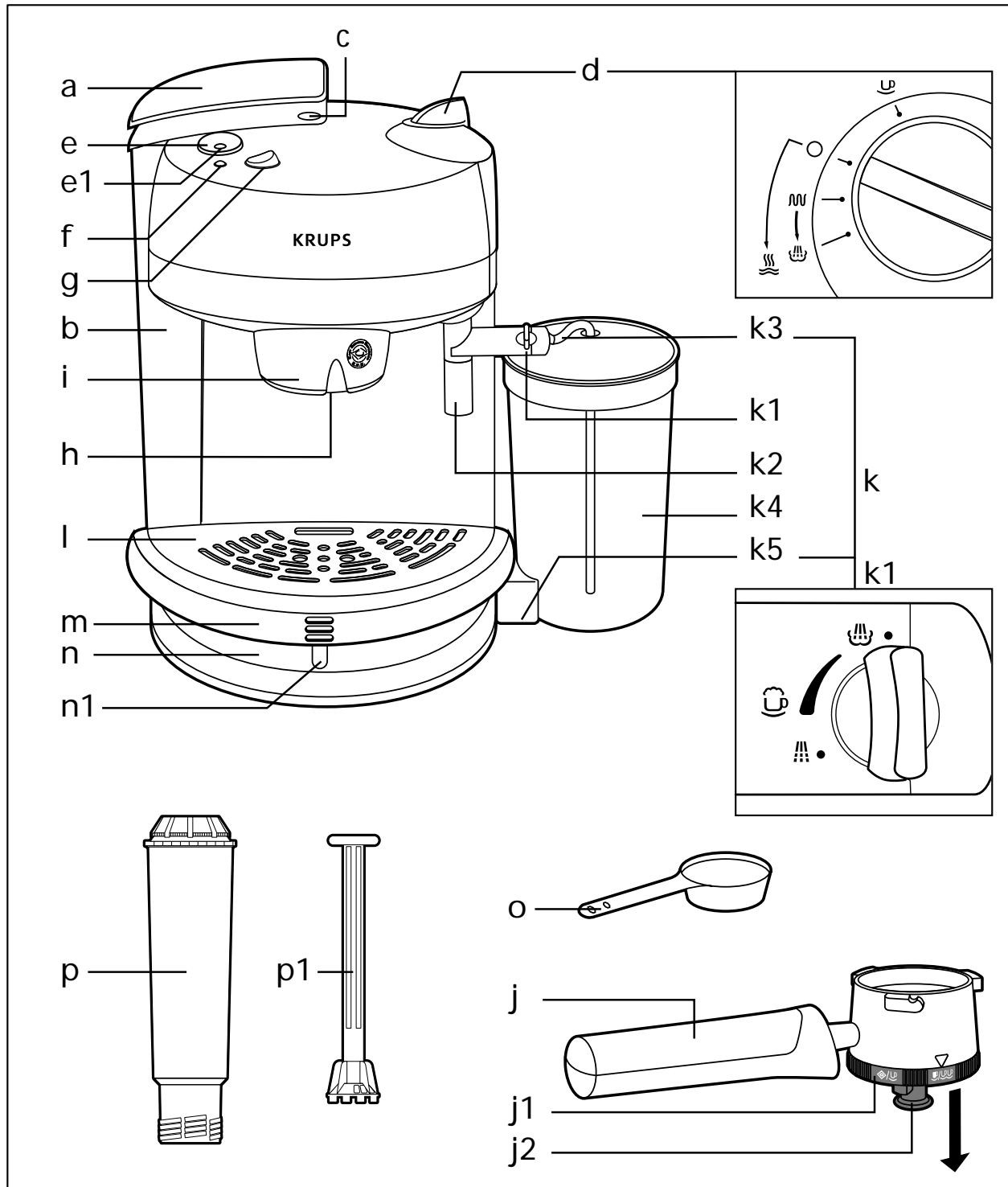
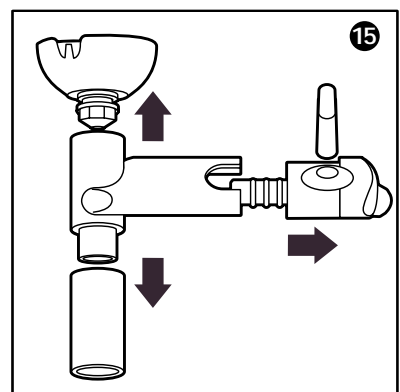
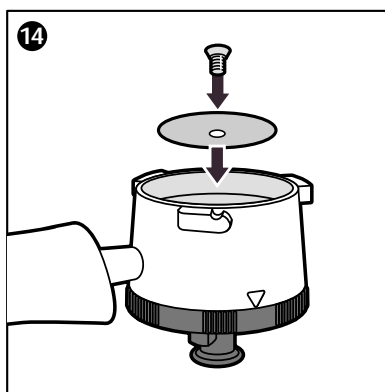
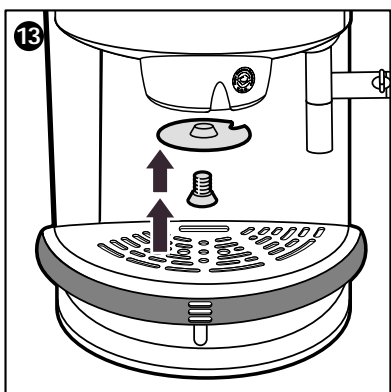
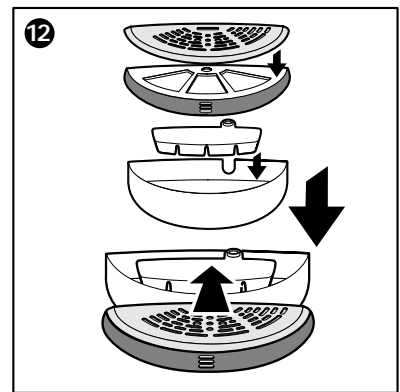
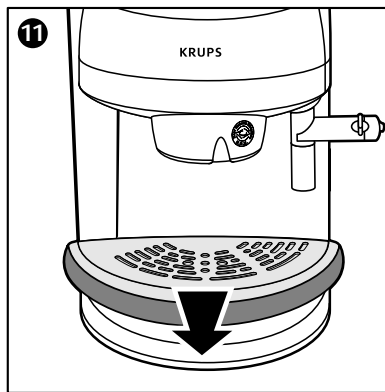
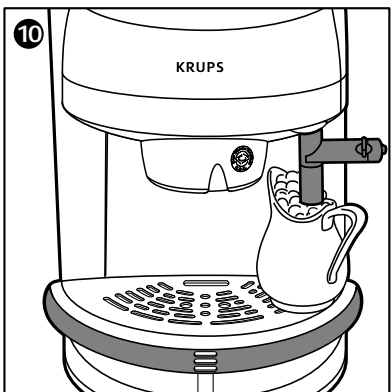
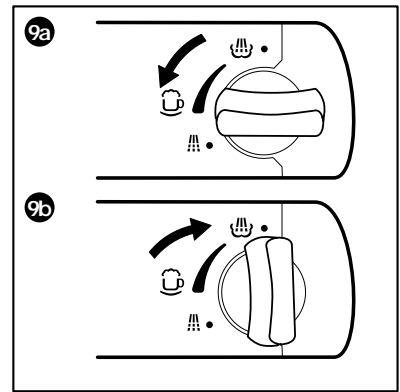
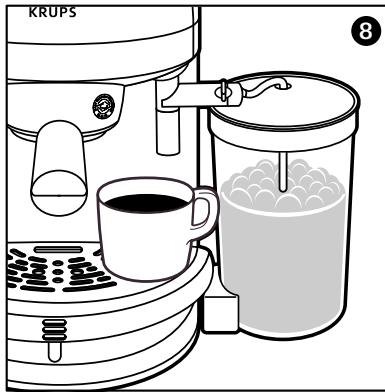
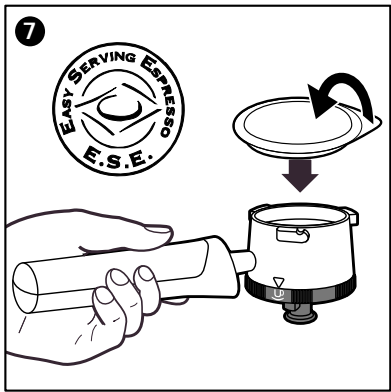
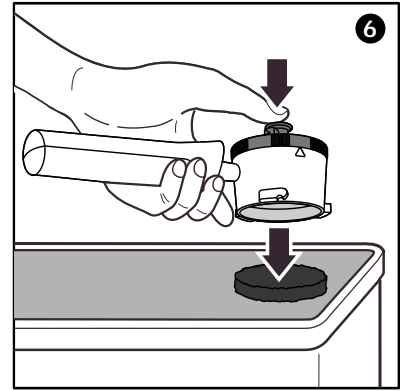
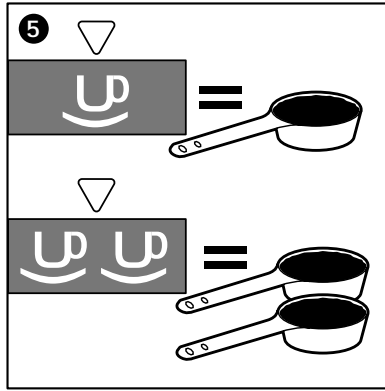
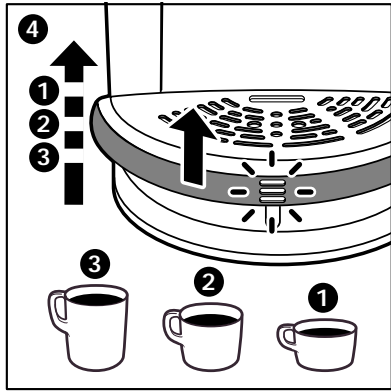

IMPORTANT SAFEGUARDS

When using electrical appliances, basic safety precautions should always be followed to reduce the risk of fire, electric shock and personal injury, including the following:

- Read all instructions carefully.
- Do not touch hot surfaces. Use handles or knobs.
- To protect against fire, electric shock and injury to persons, do not immerse cord, plugs, or appliance in water or other liquid.
- Close supervision is necessary when any appliance is used by or near children.
- Unplug from outlet when not in use and before cleaning. Allow to cool before putting on or taking off parts, and before cleaning the appliance.
- Do not operate any appliance with a damaged cord or plug or after the appliance malfunctions, or has been damaged in any manner. Return appliance to your nearest authorized KRUPS Service Center for examination, repair or adjustment (see Guarantee of Performance).
- The use of an accessory not evaluated for use with this appliance may cause injuries.
- Do not use outdoors.
- Do not let cord hang over edge of table or counter, or touch hot surfaces.
- Do not place on or near a hot gas or electric burner, or in a heated oven.
- To disconnect, turn switch to "OFF", then remove plug from wall outlet.
- Do not use appliance for other than intended use.
- Use extreme caution when dispensing hot steam.

SAVE THESE INSTRUCTIONS

CAUTION

- This appliance is for household use only. Any servicing other than routine cleaning and user maintenance should be performed by authorized KRUPS service personnel only (see Guarantee of Performance).
- Do not immerse base in water.
- To reduce the risk of fire or electric shock, do not remove the base of the machine. There are no user serviceable parts inside. Repairs should be performed by authorized KRUPS service personnel only.

SPECIAL CORD SET INSTRUCTIONS

Regarding your Cord Set:

- A. A short power-supply cord is provided to reduce risks resulting from entanglement in a longer cord.
- B. Longer extension cords are available and may be used if proper care is exercised in their use.
- C. If a long extension cord is used, (1) the marked electrical rating of the extension cord should meet or exceed the electrical rating of the appliance, (2) if the appliance is of the grounded type, the extension cord should be a grounding-type 3-wire cord, and (3) the longer cord should be arranged so that it will not drape over the counter top or table top where it can be accessed by small children or readily tripped over.
- D. This appliance has a polarized plug (one blade is wider than the other). To reduce the risk of electric shock, this plug is intended to fit into a polarized outlet only one way. If the plug does not fit fully in the outlet, reverse the plug. If it still does not fit, contact a qualified electrician. Do not attempt to modify the plug in any way.

Description

a	Lid
b	Removable and swivelling water tank
c	Cartridge change indicator
d	Function selector
e	On/off switch
e1	Operating indicator light
f	Temperature control indicator light
g	Steam/hot water button
h	Percolation head
i	Swivelling ring
j	Filter holder
j1	Selection ring : 1 cup (ground coffee) / 1 measure «ESE» 2 cups (ground coffee)
j2	Ejection button
k	Auto-cappuccino accessory
k1	Adjustable steam tap
k2	nozzle
k3	Flexible frothing tube
k4	Milk container with lid
k5	Milk container support
l	Removable grid plate
m	Adjustable grid plate support
n	Removable drip tray
n1	Water level indicator
o	Measuring spoon
p	Filter cartridge
p1	assembly key

Safety instructions



- **Read the instructions for use carefully before using your appliance for the first time and retain them for future use: any use which does not conform to the instructions for use will absolve KRUPS from any liability.**
- **Do not leave the appliance within reach of unsupervised children. The use of this appliance by young children or by disabled persons must be supervised at all times.**

- Check that the power rating of the appliance does in fact match that of your electrical system.

- **This appliance must be connected to an earthed socket.**

Any connection error will nullify the guarantee.

- This appliance is intended solely for domestic and indoor use.
- Unplug the appliance as soon as you have finished using it and when you clean it.
- Do not use the appliance if it is not working properly or if it has been damaged. In this event, contact an approved KRUPS Service Center (see list in the service booklet).
- Any intervention apart from cleaning and normal maintenance by the customer must be carried out by an approved KRUPS Service Center.
- Do not place the appliance, the power cord or the plug in water or in any other liquid.
- Do not allow the power cord to hang down within reach of children.
- The power cord must never be close to or in contact with the hot parts of your appliance, close to a source of heat, or on a sharp edge.
- Do not unplug the appliance by pulling on the cord.
- If the power cord or the plug are damaged do not use the appliance. To avoid any risk these must be replaced by an approved KRUPS Service Center (see list in the service booklet).
- Do not place the appliance on a hot surface such as a hotplate and do not use it close to a open flame.
- For your own safety, use only KRUPS spare parts and accessories which are suitable for your appliance.
- Do not use the appliance when the drip tray and the grid plate are not in position.
- Check that the filter holder is correctly positioned before making coffee and reset the function selector (d) to **O** before removing the filter holder.
- Do not remove the filter holder containing the ground coffee while water is running through, as the appliance is under pressure at that time.

- All appliances undergo strict quality controls. Practical use tests are conducted with appliances selected at random, which explains any signs of use.

Espresso coffee

Espresso coffee is richer in flavor and stronger than a normal coffee. It is traditionally drunk from small espresso cups which have been pre-heated. Hot water and pressure passes through the ground coffee to obtain this delicious black, foamy coffee which has an invigorating effect.

You can always recognize genuine espresso by its characteristic flavor and rich, delicious foam (crema). But this requires both high pressure and your favorite espresso coffee (which has been well roasted) and correctly ground. If you cannot buy ground espresso coffee, use a coffee grinder to grind the beans. The coffee must not be ground «too fine». It should be slightly grainy. If it is too fine, you run the risk of blocking the grids of the percolation head and of the filter.

To guarantee complete success in making a good espresso, it is necessary to use fresh, clean, cold water - free of chlorine or other impurities that can ruin the taste of your coffee.

Before first use

. Fitting the filter cartridge (p) :

- Assemble the 2 parts of the key (p1).
- Unpack the cartridge and properly place the key in position to insert cartridge into machine.
- Position the cartridge in the tank and screw into place **(1)** then remove the key.

The cartridge change indicator (c) lets you know when the filter cartridge needs to be changed:





- . place the left part of the notch at the number indicating the month when you first inserted the filter cartridge,
- . the right part of the notch will indicate the month when you will need to change the cartridge.

E.g. : if the left part of notch is at «1»

(January), you will have to change the filter in «3» (March).

. Cleaning the heating system

Clean the water heating system with one or two tanks of water, as follows :

- Remove the lid of the water tank (a), lift out the tank (b) and fill it with water **(2)**.
- Replace the tank, positioning it firmly in such a way that the connecting valve situated beneath the tank opens, and replace the lid.
- Plug in the appliance.
- Set the switch (e) to «I». The indicator light (e1) comes on.
- Fit the filter holder (without coffee) onto the percolation head. To do this :
 - . turn the swivelling ring (i) to the far left to a fully locked position.
 - . engage the handle of the filter holder in the slot and turn the assembly to the right until it locks (click) **(3)**.
- Place as large a container as possible under the filter holder. You can adjust the height of the grid according to the height of the container. To raise or lower the grid, pull outwards on the grid plate support (m), select one of the 3 positions and slide the support horizontally (m) back onto the drip tray (n) **(4)**.
- As soon as the appliance reaches the right temperature, the temperature control indicator light (f) will illuminate. Turn the function selector (d) to the position «» and allow the water contained in the water tank to run through the machine.
- Once your container is full, reset the function selector (d) to the position off **O**.
- Empty the container, then repeat this operation until half the tank has been emptied.
- Now, move the container under the nozzle (k2) and turn the adjustable steam tap (k1) to the position «».
- Switch the steam/hot water button (g) to «», wait for the temperature control indicator light (f) to come on then.
- Turn the function selector (d) to the position «» and allow the water contained in the tank to run through. The tip of the nozzle (k2) must not touch the bottom of the container.

- Once the container is full, reset the function selector (d) to the off position **O**.
- Repeat this operation until the tank has been completely emptied.
- Reset the function selector (d) to the off position **O** and the switch (e) to «0».

Using the various functions of your espresso

1. ESPRESSO FUNCTION



- For best results, preheat the accessories (filter holder and cups) by running water directly into the cups (see «Before first use»).

. Preparing an espresso :

Your appliance enables you to prepare an espresso either with ground coffee or with a measure of «ESE» preportioned espresso pods.

- Fill the water tank and set the switch (e) to «I». The indicator light (e1) will come on.

a. Preparing an espresso with ground coffee :

- Align the arrow located on the filter holder with the desired position by turning the selection ring (j1) **(5)**:
«» = 1 cup
«» = 2 cups
- Put some ground coffee in the filter, firmly pressing down the ground coffee with the back of the spoon (1 measuring spoon (o) = 1 cup) **(5)**.
- Clean the edges of the filter holder.
- Fit the filter holder in place under the percolation head **(3)**.
- Place one or two espresso cups under the filter holder. If necessary, adjust the height of the grid support **(4)**.

As soon as the appliance reaches the appropriate temperature, the indicator light (f) will illuminate.

- Now, turn the function selector (d) to the position «».
- When the cups are full, turn the function selector (d) to the off position **O**.
- Slowly remove the filter holder, as there may be a buildup of hot water still remaining in

the filter, and remove the ground coffee by pressing the ejection button (j2) **(6)**.

The filter holder can now be refilled to prepare more espressos.

b. Preparing an espresso with a measure of « ESE »

- Use only «ESE» type pods.

The E.S.E system was designed for making espresso «ristretto» (pressed) Italian-style for a quantity of coffee of between 35 and 50 ml.

«ESE», stands for «**E**asy **S**erving **E**spresso». It is a pre-measured pod of coffee which has been selected, ground and compacted between two filter papers, rendering it ready-to-use. This system simplifies the preparation of an espresso by avoiding the need to measure and tamp ground coffee - making it significantly easier to clean and care for the appliance.

It is neither intended nor recommended that you make a long coffee with these pods.

We advise that you take care not to damage the «ESE» pods during handling and storage.

- Align the arrow located on the filter holder with the position « 1 cup » «» by turning the selection ring (j1) **(5)**.
- Place the measure in the filter holder. In the case of an ESE pod with flaps, fold the flaps down towards the interior **(7)**.
- Put the filter holder in place under the percolation head **(3)**.
- Place a cup under the filter holder. If necessary, adjust the height of the grid support **(4)**.

As soon as the appliance reaches the appropriate temperature, the indicator light (f) will illuminate.

- Now, turn the function selector (d) to the «» position.
- Once the recommended quantity of coffee has been reached, turn the function selector (d) to the off position **O**.
- Slowly remove the filter holder, as there may be a buildup of hot water still remaining in the filter, and throw away the used ESE pod by pressing the ejection button (j2) **(6)**.

2. STEAM FUNCTION

The thumping noise which occurs while steam is being produced comes from the intermittent regulation of the pump and has no effect on the proper working of the appliance.

Caution : During and after use of the machine, the metallic parts of the Auto Cappuccino accessory can become extremely hot.

. Preparing frothed and steamed milk for a cappuccino, a latte or hot chocolate

The steam function together with the Krups Auto Cappuccino accessory (k) makes it easy to obtain milk with varying amounts of froth for making a cappuccino, a latte or a hot chocolate,

Practical advice :

- . **Cappuccino :** 1/3 espresso, 1/3 steamed milk, 1/3 milk froth.
- . **Latte:** 1/3 espresso, 2/3 steamed milk.
- . **Hot chocolate:** 1 cup hot milk, as frothy as you like, mixed with powdered chocolate.

. To froth milk :

- Fill the water tank (b) and turn the switch (e) to «I». The indicator light (e1) comes on.
- Turn the steam/hot water button (g) to the position «☕».
- Turn the function selector (d) to the position «☕».
- Pour the milk into the milk container provided (k4). For best frothing results, use fresh, cold low-fat milk.
- Place the milk container (k4) together with the lid in place on the container support (k5).
- Insert the flexible tube (k3) into the opening in the lid of the container. The tube must be fully submerged in the milk to obtain a perfect froth **(8)**.
- Turn the adjustable steam tap (k1) to the position «☕» to obtain a smooth, rich milk froth **(9a)**.
- To obtain less frothy milk, turn the steam tap (k1) to the top of the user scale **(9b)**.
- Place a cup under the nozzle (k2) **(8)**. If necessary, adjust the height of the grid support **(4)**.

As soon as the appliance reaches the appropriate temperature, the indicator light (f) will illuminate.

- Turn the function selector (d) to the position «☕» until you obtain the desired quantity of frothy milk.
- Turn the function selector (d) to the position «☕» and remove the cup.
- Recommence the operation if you want another cup, or turn the function selector (d) to the off position **O**.
- If you wish to make an espresso immediately after heating or frothing, the appliance must first cool down :
 - . place a container under the empty and correctly positioned filter holder, then turn the function selector (d) to the position «☕».
 - . let water run through until the indicator light (f) goes out. Then, turn the function selector (d) to the off position **O**.

After doing this, the machine is now ready to once again make an espresso (see paragraph «Espresso function»).

Caution : Metallic portions of Auto Cappuccino system will be extremely hot immediately after use. Allow time for the appliance to cool down to prevent scalding or burning.

Notes :

- Store the milk container (k4) holding the unused portion of the milk in the fridge.
- . **Heating thick liquids (e.g. soup) :**
 - Fill the water tank (b) and set the switch (e) to «I». The indicator light (e1) comes on.
 - Turn the steam/hot water selector (g) to the position «☕».
 - Turn the function selector (d) to the position «☕».
 - Turn the tap (k1) to the position «☕».
 - Immerse the nozzle (k2) into the liquid to be heated **(10)**. If necessary, adjust the height of the grid plate support **(4)**. The tip of the nozzle must not touch the bottom of the container so as not to prevent the passage of the steam.

As soon as the appliance reaches the right temperature, the temperature control indicator light (f) comes on.

- Turn the function selector (d) to the position «» until the liquid is hot enough, then reset the function selector (d) to the off position **O** and remove the container.
- For instructions on cleaning the Auto Cappuccino accessory, please refer to the paragraph «Maintenance».

Important notes :

The thumping noise which occurs while steam is being produced comes from the intermittent regulation of the pump and has no effect on the proper working of the appliance.



Caution : During and after use of the machine, the metallic parts of the Auto Cappuccino accessory can become extremely hot.

- We advise you to clean the auto-cappuccino accessory immediately after use ; please refer to the paragraph «Maintenance».
- If you wish to make an espresso immediately after steam, the appliance must first cool down :
 - . place a container under the empty and correctly positioned filter holder, then turn the function selector (d) to the position «».
 - . let water run through until the indicator light (f) goes out. Then, turn the function selector (d) to the position **O**.

After this, the machine is ready once again to make espressos (see paragraph «Espresso function»).

3. HOT WATER FUNCTION

Please note : If you prepare hot water immediately after using the steam function, steam may come out of the nozzle before hot water is produced.

- Fill the water tank (b) and turn the switch (e) to «I». The indicator light (e1) comes on.
- Turn the steam/hot water selector (g) to the position «».
- Turn the steam tap (k1) to the position «».
- Place the container under the nozzle (k2) **(8)**. If necessary, adjust the height of the grid support **(4)**. The tip must not touch the bottom of the container so as not to prevent the passage of water.

As soon as the appliance reaches the right temperature, the indicator light (f) comes on.

- Turn the function selector (d) to the position «».
- Once you have obtained the desired quantity of water, turn the function selector (d) to the off position **O**.

Maintenance

Note : Never wash the accessories for your espresso maker in the dishwasher.

- Unplug the appliance and allow it to cool down.
- You can clean the body of the appliance with a damp cloth.

After usage, the water tank should be emptied to avoid limescale build-up.

. The drip tray (n)

- Each time an espresso is prepared, the drip tray (n) fills with water. This is perfectly normal. If there is any water in the fill indicator (n1), you must then empty the drip tray.
- Take off the grid and its support **(11)** and empty the drip tray (n).
- If necessary, clean the drip tray and the grid with water and a little non-abrasive liquid soap, rinse and dry. When replacing, put back the plastic block situated at the back of the tray **(12)**.

. The percolation head and the filter holder

Warning : these may be extremely hot.

These must be cleaned after every use. Simply run a damp cloth over the percolation head and clean the other accessories with water and a small quantity of non-abrasive liquid soap. Rinse and dry.

- If the percolation head (h) becomes heavily encrusted, unscrew its grid using a coin, clean it and replace, tightening it firmly **(13)**.
- If the filter holder (j) becomes heavily encrusted, unscrew its grid using a coin, clean it and replace it, tightening it firmly **(14)**.



. The seal for the percolation head

When you are not using your espresso maker, do not leave the filter holder in the appliance in order to prevent wear on the seal.

- Clean the seal of the percolation head (h) regularly using a damp cloth.

. The auto-cappuccino accessory

After each use, we advise that you rinse the auto-cappuccino accessory as follows:

- Turn the function selector (d) to the position «».
- Turn the adjustable steam tap (k1) to the position «».
- Immerse the flexible tube (k3) into the clean milk container 1/3 filled with water.
- Place a container under the nozzle (k2). If necessary, adjust the height of the grid support (4). The tube must not touch the bottom of the container so as not to prevent the passage of water.

As soon as the appliance reaches the right temperature, the temperature control indicator light (f) will illuminate.

- Turn the function selector (d) to the position «».
- When all the water has run through, turn the function selector (d) to the off position **O**.
- Once this operation is complete, clean the nozzle (k2) using a damp cloth.

We advise that you completely dismantle the auto-cappuccino accessory at regular intervals and clean it with water, a little non-abrasive liquid soap and a small brush. Rinse and dry before reassembling (15).

Pay attention to the direction of the fitting of the flexible tube : place the straight-cut end in the Auto Cappuccino accessory and the angled end into the container.

Descaling

It is vital that you descale your espresso maker in order to guarantee its continued operation.

- Descale your espresso maker at regular intervals using the descaling powder included with your machine.

We advise you to use the **KRUPS descaling accessory, reference 054**, which is available from approved KRUPS Service Centers. This accessory includes, in addition to two doses of descaler, a water hardness test strip to evaluate the frequency of descaling for your





appliance in normal use. The amount of scaling depends on the hardness of the water you use and also on how often it is used. The frequency of descaling indicated by accessory 054 is thus given by way of indication only.



You must never, under any circumstances, use classic sulphamic acid or other products containing this acid as there is a risk of damaging the appliance. Carefully check the composition of the descaling products you intend to use.

- Then use the following method:

- Remove the filter cartridge (p) by unscrewing it using the key (p1).
- Unscrew the grid of the percolation head (h) and clean it (13).
- Dissolve 2 tablespoons of descaler or one sachet of accessory 054 in half a litre of lukewarm water and pour the mixture into the empty water tank.
- Set the switch (e) to «I». The indicator light (e1) will come on.

As soon as the appliance reaches the correct temperature, the temperature control indicator light (f) will illuminate.

- Place a container under the nozzle (k2), then switch the steam/hot water button (g) to «».
- Turn the tap (k1) to the position «».
- Run through 1/3 of the mixture by setting the function selector (d) to the position «». Then reset the function selector (d) to the off position **O**.
- Move the container under the percolation head (h) and run through the second third of the mixture by setting the function selector (d) to the position «».
- Set the switch (e) to «0» and wait 10 to 15 minutes to allow the descaler to work.
- Then set the switch (e) to « I ».
- With the function selector (d) in the position «», allow the remainder of the mixture to run into the container placed beneath the percolation head (h).
- Then, reset the function selector (d) to **O**.
- Run through two tanks of fresh water to rinse the percolation head and the nozzle. To do this :
 - . Fill the tank

- Place a container under the percolation head, set the function selector (d) to «» and allow the contents of the tank to run through.
- Refill a new tank.
- Place a container under the steam nozzle, set the function selector (d) to «» and allow the content of the tank to run through.
- Then, reset the function selector (d) to **O** and the on/off switch (e) to «0».
- Replace the grid on the percolation head (h) by screwing it back on firmly using a coin (see «Maintenance»).
- Replace the filter cartridge (see «Before first use»).

Notes :

In the case of serious scaling, soak the grid of the percolation head for 5 minutes in 1/3 of the mixture obtained during the first run-through.

If necessary, this operation can also be performed with the steam nozzle :

- To do this, dismantle the nozzle as instructed in the paragraph «Maintenance» and soak the scaled parts for 5 minutes in 1/3 of the mixture obtained during the first run-through. Rinse the various parts thoroughly before replacing them.

Problems, likely causes and corrective actions

Problems	Probable causes	Corrective actions
Espresso not hot enough.	The accessories are cold (cups and filter holder).	Pre-heat the accessories See the paragraph «Preparing an espresso».
	The appliance is not hot enough.	Wait for the indicator light (f) to come on.
Coffee leaks around the filter holder	The filter holder is not fitted correctly.	See paragraph «Before first use ».
	There is still some coffee on the edge of the filter.	Clean around the filter and the seal.

Coffee leaks around the filter holder	The seal of the percolation head is dirty.	Clean the seal with a damp cloth.
	The seal of the percolation head is defective.	Contact an approved KRUPS Service center.
Very loud noise from the pump.	No water in the tank.	Fill the tank.
	Water tank badly fitted.	Press firmly on the tank
	Ground coffee too old or very dry.	Use freshly ground coffee.
Water does not run through.	No water in the tank.	Fill the tank.
	Tank badly fitted.	Press firmly on the tank.
	The filter is blocked, the ground coffee is too fine or too compacted.	Clean the filter holder and the grid of the percolation head. See the paragraph «Maintenance » and try using a coarser or less compacted coffee.
	Grid of the percolation head encrusted.	Put the grid to soak in the descaling solution. See the paragraph «Descaling».
	Appliance scaled.	See the paragraph «Descaling».
Water passes too quickly.	Ground coffee too coarse.	Try a finer ground coffee.
	Insufficient quantity of ground coffee.	Use the spoon supplied to measure out the coffee.
	Ground coffee not compacted.	Compact the ground coffee more.
The espresso has no crema (foam on the espresso).	Ground coffee too coarse.	Try using a finer ground coffee.
	Ground coffee not compacted enough.	Compact the ground coffee more.
	Ground coffee old or too dry.	Use a fresh ground coffee.

The milk is not very foamy.	Nozzle blocked	See paragraph «Maintenance».
	Milk too old.	Use fresh milk
	Milk is lukewarm.	Put the milk in the refrigerator.
When using E.S.E, coffee leaks around the filter holder.	Measure badly positioned.	Position it correctly (See paragraph «Preparing an espresso with an «ESE» measure»).
	Filter holder not tightened properly.	Tighten it until it locks (click).
Lots of water in the ground coffee.	Ground coffee not compacted.	Compact the ground coffee using the spoon provided.
	Insufficient quantity of ground coffee.	Increase the quantity of ground coffee.
There is water around the appliance.	The drip tray is overflowing.	Empty it regularly.

Accessories

You can obtain the following accessories from your retailer or from an approved KRUPS Service center :

- . Filter cartridge: ref. 088
- . Descaling kit: ref. 054

Limited One Year Warranty

Your KRUPS #F922 is covered by the following warranty :

If within one year from date of purchase this KRUPS product fails to function because of defects in materials or workmanship, KRUPS North America will, at its option, repair or replace the unit without charge, provided the owner has a proof of date of purchase.

This warranty will be void if malfunction was caused by damage to the product by accident, misuse, use on frequency or voltage other than marked on the product and/or described in the instructions, abuse including tampering, damage in transit, or use for commercial purposes. This warranty gives you specific legal rights, and you may also have other rights which may vary from state to state.

GUARANTEE OF PERFORMANCE

This fine KRUPS product is manufactured according to a rigid code of quality standards, and, with minimum care, should give years of service. However, should the need arise for repairs or for replacement parts within or after the warranty period, please call our CONSUMER SERVICE DEPARTMENT:

USA : (800) 526-5377
24-hours a day, 7 days a week
Canada : (905) 669-0114
Monday-Friday 8:00 a.m - 4:30 p.m

You will be provided with specific instruction on how to get your product repaired.

The department will also be able to answer any general product questions you may have.

Before calling the Consumer Service Department, please have the type number of your KRUPS appliance available.

You must have this information before calling our Consumer Service Department so that we may better answer your questions. The type number can be located by looking at the bottom of your appliance.

This product is Type #F922

Any general correspondance can be addressed to:

USA : KRUPS North America, Inc.
P.O. Box 3900
Peoria, IL 61612

Canada : KRUPS Service
20 Caldari Rd
Concord, Ontario
L4K 4N8