

VESTEL

F4 TOUCH PYTHON BLDC SERVICE MANUAL

1. Specifications

1.1. Product Specifications

		50 lt	55 lt	61 lt	62 LT
Product Type	Front Loader				
Capacity		7 kg	8 kg	9 kg	10 kg
Max Spin Speed (r/min)	800 - 1000 - 1200 - 1400 - 1600				
Energy Efficiency	A+++ -%20				A+++ -%10
Washing Efficiency	A				
Spinning Efficiency	600 rpm → E 800 rpm → D 1000 rpm → C 1200 rpm → B				
Control Panel	LED display -				
Wash Programs	15 settings				
Dimensions	Height	84,5 cm	84,5 cm	84,5 cm	
	Width	59,7 cm	59,7 cm	59,7 cm	
	Depth	52,7 cm	55,7 cm	58,2 cm	
Other Features	Child Lock				
	Delay Time				

1.2. Name Plate

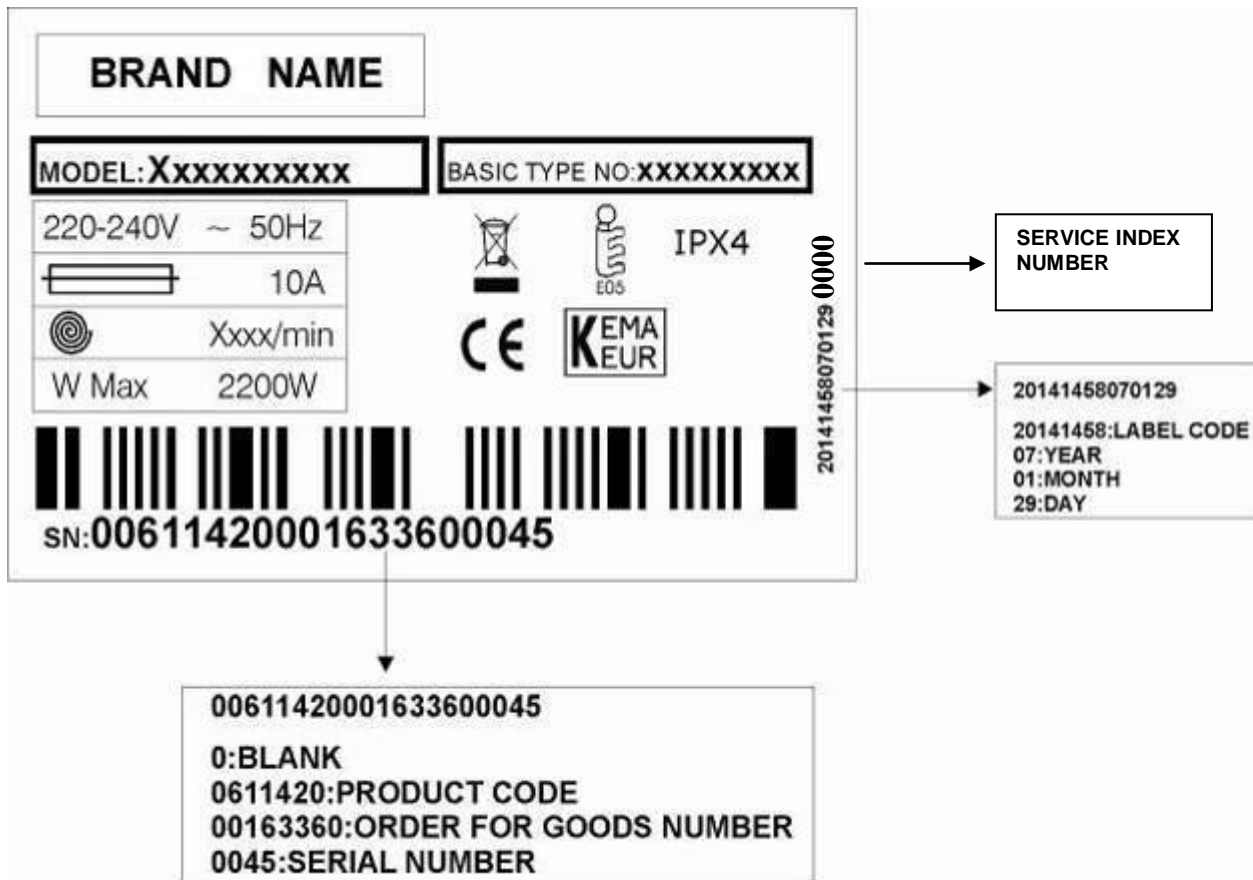

2. Installation Instructions

2.1. Moving and Installing

2.1.1. Removal of Transportation Screw

1. Transportation screws, which are located at the back side of the machine, must be removed before running the machine.
2. Loosen the screws by turning them anticlockwise with a suitable spanner.

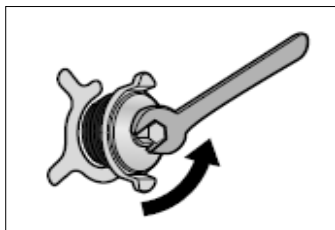

3. Pull out the screws and rubber washers.

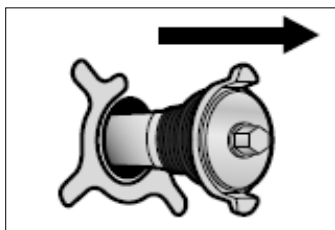

4. The holes where the transport screws have been removed should be covered with the plastic transport caps found in the accessories bag.

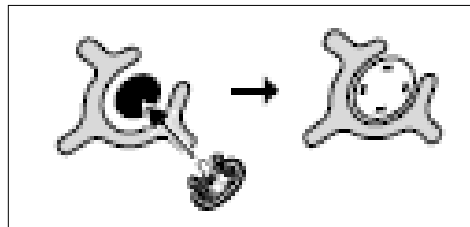

5. The transportation screws that have been removed from the machine must be re-used in any future transporting of the machine.

2.1.2. Foot Adjustment

1. Do not install machine on rugs or similar surfaces.
2. For machine to work silently and without any vibration, it should be installed on a flat, non-slippery firm surface. Any suspended floor must be suitably strengthened.
3. You can adjust the level of machine using its feet.
4. First, loosen the plastic adjustment nut away from the cabinet base.

5. Change the level by adjusting the feet upwards or downwards.
6. After level has been reached, tighten the plastic adjustment nut again by rotating it upwards against the base of the cabinet.
7. Never put cartons, wooden blocks or similar materials under the machine to balance irregularities of the floor.

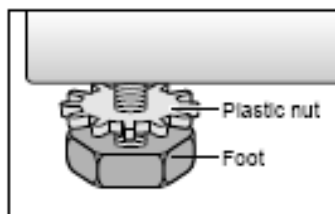

2.1.3. Electrical Connection

1. Washing machine requires a 50Hz supply of 220-240Volts.
2. A special earthed plug has been attached to the supply cord of washing machine. This plug must be fitted to an earthed socket. The fuse value fitted to this plug should be 13 amps. If you have any doubts about electrical supply, consult a qualified electrician.

**THIS APPLIANCE MUST BE EARTHED.
Insert the machine's plug to a grounded
socket which you can easily reach.**

2.1.4. Water Supply Connection

1. Washing machine is supplied with a single (cold) water inlet.
2. To prevent leakage from the connection joints, a rubber washer is included in the hose packing. Fit this washer at the end of water inlet hose on the tap side.
3. Connect the hose to the water inlet valve. Tighten the plastic connector by hand. Please call a qualified plumber if you are unsure about this.
4. Water pressure of 0,1-1 MPa from tap will enable machine to work more efficiently.(0,1 MPa pressure means water flow of more than 8 litres in 1 minute from a fully opened tap)

2.1.5. Drain Connection

1. Make sure that water inlet hoses are not folded, twisted, crushed or stretched.
2. The drain hose should be mounted at a minimum height of 60 cm, and a maximum height of 100 cm from the floor.

5. After connection is complete, check for leakage by turning on tap completely.
6. Make sure that water inlet hoses can not become folded, damaged, stretched or crushed when the washing machine is in its final position.
7. Mount the water inlet hose to a 3/4" threaded water tap.

3. The end of the drain hose can be connected directly to a drainage stand-pipe or alternatively to a specific connection point designed for that purpose on the waste outlet of a sink unit.
4. Do not extend the drain hose or guarantee will be invalidated.

2.2. Detergent Box Group

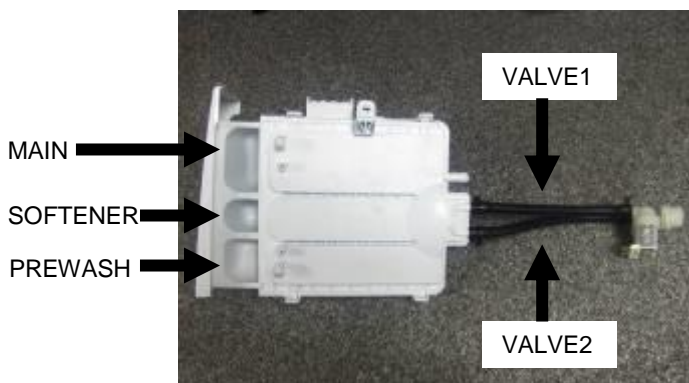

PREWASH = WATER ENTRY VALVE 1
MAIN = WATER ENTRY VALVE 2
SOFTENER = WATER ENTRY VALVE 1 + VALVE 2

3. Operating Instructions

3.1. LCD Screen, Function Buttons & Knobs

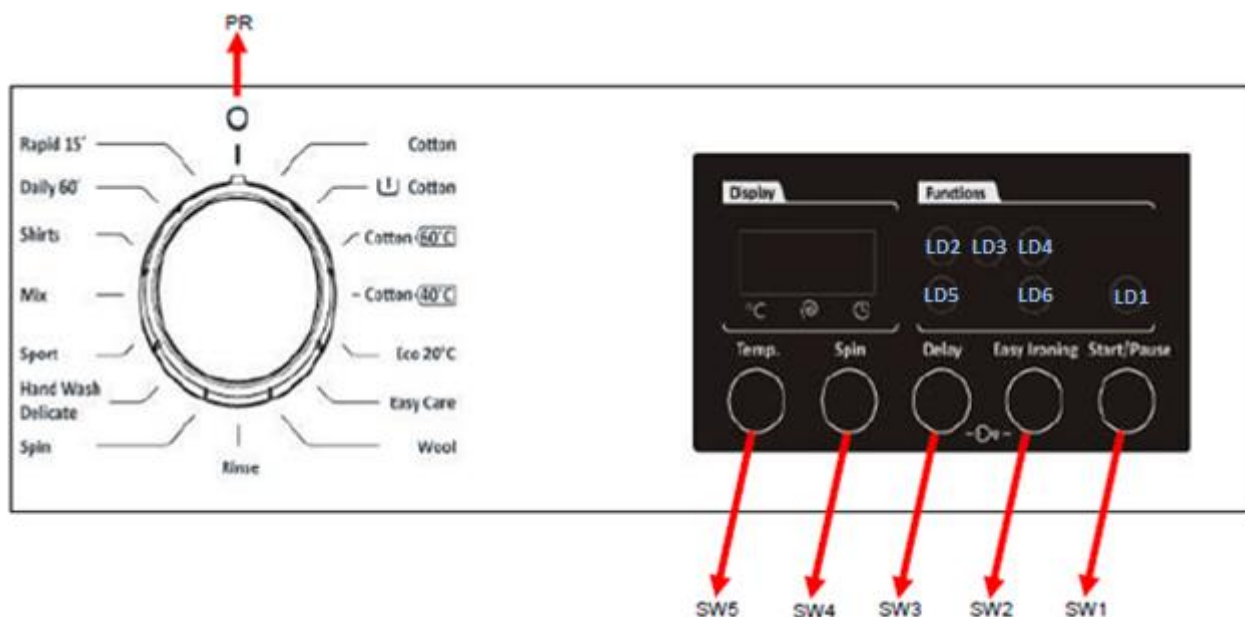

PR	ON/OFF
SW1	Start / Pause
SW2	Function 1
SW3	Delay Mode
SW4	Spin Speed Selection
SW5	Temperature Selection
LD1	Start / Pause
LD2	Wash Phase Led
LD3	Rinse Phase Led
LD4	Spin Phase Led
LD5	Delay Mode
LD6	Function 1 Led

3.2. Program List

KNOB POSITION	PROGRAM
1	Cotton 90°C
2	Cotton Prewash
3	Cotton Eco 60°C
4	Eco 20°C
5	Easy Care
6	Wool
7	Rinse
8	Allergy Safe
9	Spin
10	Delicate / Hand Wash
11	Sports Wear
12	Mix 30
13	Shirts
14	Daily 60'
15	Rapid 15'
16	STOP

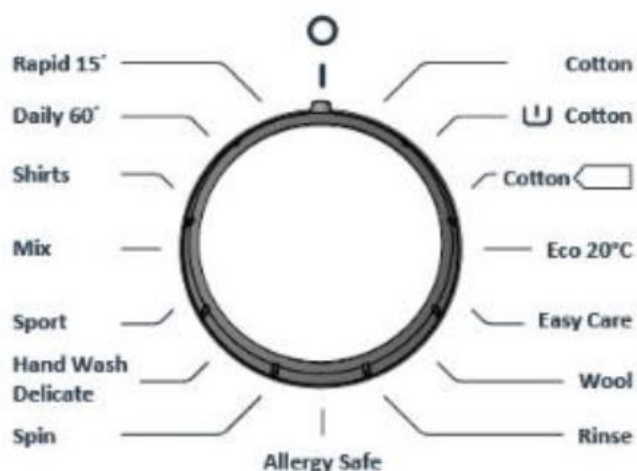

3.5. Child Lock

Activation

1. Press the SW2 and SW3 buttons simultaneously for 3 sec.
2. L4 and L5 will make fast blink for 2 sec to indicate child lock is activated.



Deactivation

1. Press the SW2 and SW3 buttons simultaneously for 3 sec.
2. L4 and L5 will make fast blink for 2 sec to indicate child lock is activated.



Child lock during the programme

1. Machine does not respond to any pressing of buttons or changing position of program knob. When the user tries to change programme knob during child lock, for F2A, F2B and F2C panels, L4 and L5 will make fast blink for 2 sec.

In end condition

1. When cycle is finished child lock is automatically deactivated.

In Error Mode

1. Child lock will be automatically deactivated when error is detected.

4. Test Mode

4.1. Autotest

* This test is for quick checking of the product. You can not see the failure codes.

1. Press SW5 button and simultaneously position program knob to 1



2. After 3 sec, door will be locked and the auto test starts.

The test steps are as below;

Step1: The pump is activated for 3 seconds and there is EPS check, the frequency value should be between the 46.04Hz and 43.40Hz. It checks the EPS and if it is OK it continues the autotest; if it is NOK then it should give E10 ERROR & cancels the autotest (goes to the selection mode). Also if any frequency can not be detected, then it means there is problem with connection or EPS, so it gives E10 which is EPS error and cancels the autotest. L1-L3 and L4 should fast blink during E10 error for panels except F4.

Step2: The motor ramps to max spin for 15 seconds. While its speed rising up to the maximum speed the EV1 (prewash valve) is activated for 5 seconds and then the EV2 (wash valve) is activated for 5 seconds.

Step3: The motor reduces speed to stop (depends on the motor stop time) for 5 seconds. While it is slowing down it activates EV1 and EV2 valve, concurrently.

Step4: The motor turns to right.

Step5: The motor turns to left for 5 seconds. Test is stopped. In that period, the Pre Wash icon makes fast blink.

Step6: The option 1 button is pushed

The EV1 and EV2 are activated concurrently until it reaches pressure sensor's first level frequency (Hz) for 5 seconds.



Step7: Software will detect NTC's resistance value and will check if the temperature is between $5^{\circ}\text{C} < T_{\text{detected}} < 40^{\circ}\text{C}$. If it is inside the range, heating step will be done. If temperature value is outside the range, then it means NTC is detecting the temperature in a wrong way and heating step will be skipped.

Step8: Autotest ends and "End" is visualized on LCD for F4. For F2B, F2A, F2B and F2C "End" led will be fix on.

AUTOTEST													
Time in seconds (to be adjusted)	5	10	15	20	25	30	35	40	45	50	55	60	65
Entering autotest	█	█											
Changing power to 220 50Hz		█											
Main Voltage 50 Hz			█	█	█	█	█	█	█	█	█	█	█
Door Lock Powered (Depends on door lock)			█	█	█	█	█	█	█	█	█	█	█
Motor Ramp to max spin (max. is 15 sec.)				█	█	█	█	█	█	█	█	█	█
Time until motor is stopped (Depends on the motor stop time)							█	█					
Motor Preferred Run (Direction to Right)									█	█			
Motor Inverse Run (Direction to Left)										█	█		
EV1 (flowrate dependent of washer)				█	█			█	█				
EV2 (flowrate dependent of washer)						█	█	█	█				
Test stopped until Prewash button is pressed (symbol blinking)(REMOVED)	█	█	█	█	█	█	█	█	█	█	█	█	█
EV1 + EV2 valves up to first level frequency (Depends on the water level) (If machine is a hot water one, take water from Hot Valve)											█	█	
NTC check												█	
Heather resistance												█	█
Pump				█									
EPS measurement													

Sayfa 1

5. Service Mode

5.1. Service Autotest

End users can only see E1-E2-E3-E4. During service autotest, other failures can be seen.

1. To activate service autotest, Press SW4 button and simultaneously position program knob to 1.
2. After 3 sec, door will be locked , after door is locked, all leds will be fix OFF and machine will get into service autotest mode.

	Selector Position 1	Selector Position 2	Selector Position 3
	Result	Result	Result
	HEATER ON	PUMP ON	TEST PROGRAM ON
Comments :	When entering in service test, door will be locked.		TEST IS OVER Door will be unlocked, machine will go to END state.

The test steps are as below ;

Step 1 :

Selector position 1 will be "HEATER ON"

Before heating it should take water till first level frequency then start heating.

Heater will be on max. 8 minutes.If temperature doesn't increase 2°C in 8 minutes,machine will give NTC failure. (E05).

Or if the NTC connection is broken then it should give again E05 NTC failure.

L2 and L4 should fast blink during E05 error.

At the end of heating, "SAU" visualization should make slow blink to indicate that the step is over.

Note : If user changes the selector position, machine will do what is defined for the new selected position.

LD1 → Star/ Pause Led → Slow Blink

LD2 → Wash Phase Led → Slow Blink

LD3 → Rinse Phase led → Off (Except Rinse program. For Rinse program L2 makes slow blink)

LD4 → Spin Phase Led → Off (Except Spin program. For Spin program L4 makes slow blink.)

LD5 → Delay Timer Led → Off (If it is selected → On)

LD6 → Function Led → Off (If it is selected → On)

Step 2 :

Selector position 2 will be "PUMP ON"

Temperature will be measured, if it is higher than 50°C, it should take 80sec. cooling water and then make "Drain+ 5sec.)

At the end of pump activation, "SAU" visualization should make slow blink to indicate that the step is over.

Step 3 :

Selector position 3 will be "RAPID 15' "

So machine will make exactly the same algorithm of Rapid 15'.

So, time for selector position 1 is 15 minutes.

At the end of Rapid 15' the door will be unlocked and machine will go to END mode.

5.2. Failure Codes

Error Indication	Error Number	Indication For User	Indication For Service
		Yes/No	Yes/No
Door is not locked	E01	Yes	Yes
Door is unlocked during programme	E01	Yes	Yes
Lack of water	E02	Yes	Yes
Pump failure	E03	Yes	Yes
Overflow	E04	Yes	Yes
NTC or Heater Failure	E05	No	Yes
Motor Failure - 1 (Tachometer open-short circuit or motor connector is disconnected)	E06	No	Yes
Configuration Failure	E07	No	Yes
Motor Triac Failure	E08	No	Yes
Voltage Error	E09	Yes	Yes
Electronic Pressure Sensor	E10	No	Yes

6. Troubleshooting Guide

All repairs which must be done on the machine should be done by authorized agents only. When a repair is required for machine or you are unable to eliminate the failure with the help of the information given below:

- Unplug the machine.
- Close the water tap.

FAILURE	PROBABLE CAUSE	METHODS OF ELIMINATION
Machine does not operate.	It is unplugged.	Insert the plug into the socket.
	Fuse is defective.	Change fuse.
	Start / Pause button has not been pressed.	Press the start / pause button.
	The program knob is in 0 (off) status.	Bring the program knob on the desired status.
	The door is not shut properly.	Shut the door properly. You should hear the click.
	Child lock is active.	See page 9.
Machine does not receive water.	Water tap is closed.	Open water tap.
	The water inlet hose may be bent.	Check the water inlet hose.
	The water inlet hose is obstructed.	Clean the filters of water inlet hose.
	The water inlet filter is obstructed.	Clean the valve inlet filters.
	The door is not shut properly.	Shut the door properly. You should hear the click.
Machine is not draining water.	The drain hose is obstructed or bent.	Check the drain hose.
	The pump filter is obstructed.	Clean the pump filter.
	The clothes are not placed inside the machine in a well-balanced manner.	Spread the clothes inside the machine in an orderly and well-balanced manner.
Machine is vibrating.	The feet of machine are not adjusted.	Adjust the feet.
	Transportation screws are not removed.	Remove transportation screws.
	There is a small amount of clothes in the device.	It does not prevent operation of the machine.
	Excessive amount of clothes are filled in the machine or the clothes are not placed in a well-balanced manner.	Do not exceed the recommended quantity of clothes and spared clothes in the machine in a well-balanced manner.

FAILURE	PROBABLE CAUSE	METHODS OF ELIMINATION
Excessive foam in the detergent drawer	Too much detergent has been used.	Press the start/pause button. In order to stop the foam, dilute one table-spoon of softener in half liter of water and pour it in the detergent drawer. Press the start/pause button after 5-10 minutes. Arrange the amount of the detergent properly in the next washing process.
	Wrong detergent has been used.	Use only the detergents produced for full automatic machines.
The washing result is bad.	Laundry too dirty for the program you have selected.	Select a suitable program.
	The amount of detergent used is not sufficient.	Use more detergent according to the detergent.
The washing result is not good.	Clothes exceeding the maximum capacity has been filled in machine.	Put the clothes in machine in a manner not to exceed its maximum capacity.
	Water may be hard.	Use the amount of detergent according to the declaration of the detergent producer.
	Distribution of the clothes in machine is not well-balanced.	Spread the clothes inside the machine in an orderly and well-balanced manner.
The water is seen in the drum during washing.	No failure. The water is at the lower part of the drum.	
There are residues of detergent on the clothes.	The pieces of some detergents which do not dissolve in water may stick to clothes as white stains.	By calibrating machine for "Rinsing" program, make an additional rinsing or eliminate the stains After drying with the help of a brush.
There are grey stains on the clothes.	These stains may be caused by oil, cream or ointment.	In the next washing operation, use the maximum detergent amount declared by the detergent producer.
The spinning process is not done or starts with delay.	No failure. The unbalanced load control works in that way.	The unbalanced load control system will try to distribute clothes in a homogenous manner. After clothes are distributed, passage to spinning process will be realized. In the next washing process, place clothes into the machine in a well-balanced manner.

7. Disassembly and Assembly Instructions

7.1. Top Plate

1. Remove two screws that fix the top-plate at the back.



2. Push the top-plate back and pull it up.



2. Pull the door up.



3. Remove screws that fix the door group.



7.2. Door

1. Remove two screws that fix the door. (by using the T25)



4. Put the door outside plastic with helping screwdriver as it is shown in the picture.

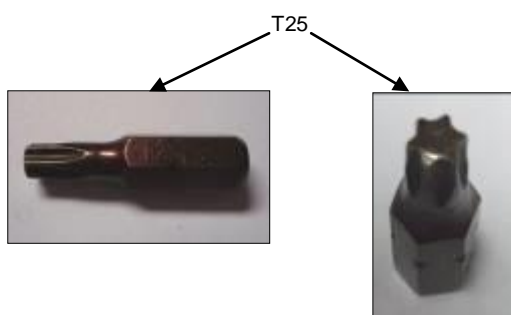

5. Remove the door inside plastic as it is shown in the picture.



8. Remove the door handle pin as it is shown in the picture.



6. Remove six screws that fix the door hinge as it is shown in the picture.



7. Remove the door handle as it is shown in the picture.



7.3. Tub Bellows Seal

1. First remove the spring wire fixing the tub bellows seal by using the small size screw driver. Pull the tub bellows seal as it is shown in the picture.



2. Remove the tub bellows seal-body fixing spring.



7.4. Detergent Drawer

1. Remove the detergent drawer and pull it up carefully



7.5. Control Panel

1. Remove the screw which fix the control panel to the front panel.



2. Remove three screws fixing the control panel.



3. Pull the control panel up.



4. Press the button as shown in the picture.



5. Remove the cable group as it is shown in the picture.



6. Remove electronic card cover as it is shown in the picture by using small screw driver.



7. Remove electronic card as it is shown in the picture.



8. Push clips to remove to selection button as it is shown in the picture.



9. Remove selection button as it is shown in the picture.



7.6. Front Panel

1. Remove the pump cover as it is shown in the picture.



2. Remove two screws fixing bottom the front panel.

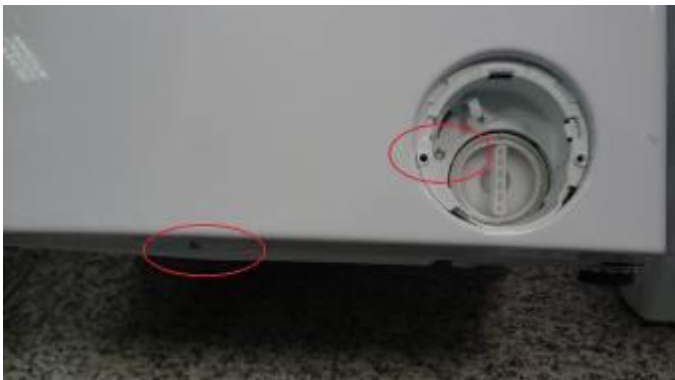

3. Remove two screws fixing upper the front panel.



4. Remove two screws fixing door lock it is shown in the picture.



5. Remove two screws fixing the body group at the front as it is shown in the picture.





6. Lift upper support bracket up slightly it is shown in the picture.



7. Remove the pump cover housing as it is shown in the picture.



8. Remove the front panel as it is shown in the picture.

7.7. Detergent Drawer Housing

1. Remove detergent drawer group two clips fixing the upper support bracket as it is shown in the picture.



1. Remove the tub seal clamp by using the pliers, which is attached to the detergent drawer housing.



2. Remove the four connectors that is connected to the feed valve as it is shown in the picture.



3. Turn the feed valve counter clockwise slightly to remove.



4. Remove the detergent drawer screw.



5. Remove the detergent drawer housing assembly.



7.8. Power Cable Group and Parazit Filter

1. Remove the five conectors that is connected to the parasite filter.



2. Remove two screws fixing the parasite filter.



3. Pull the power cable group up as it is shown in the picture.

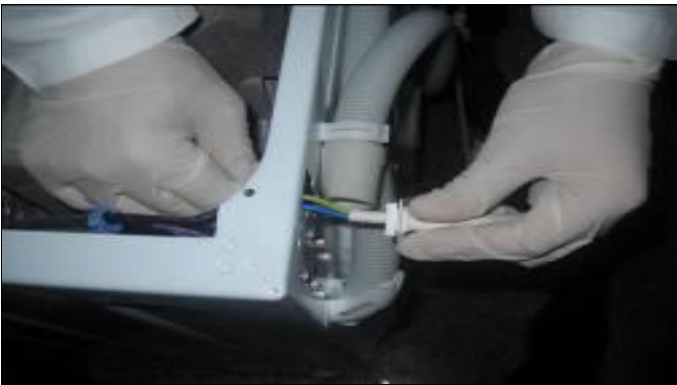

4. Remove parasite filter fixing body group as it is shown in the picture.



7.9. Electronic Pressure Switch (EPS)

1. Remove the connector that is connected to the EPS.



2. Pull the EPS upward to remove as it is shown in the picture.



3. Remove the eps hose handcuffs and eps hose as it is shown in the picture.



7.10. Door Lock

1. Remove the connector that is connected to the door lock.



7.11. Pump Motor

1. Remove pipe clip that fixes the drain hose.



2. Remove pipe clip fixing the tub outlet hose.



3. Remove the connector that is connected to the pump motor.



4. Remove four screws fixing the pump motor.



7.12. Front Counterweight

1. Remove four screws fixing the front counterweight on the front. (Box wrench size 13 mm)



2. Pull the counterweight back



7.13. Heater

1. Remove the four connectors that is connected to the heater.



2. Remove one nut fixing the heater slightly (box wrench size 8 mm)



the tub gasket clip by using small screwdriver.

2. Hold the tub bellows seal and gasket-body fixing spring together, and pull them up.



3. Hold the heater and pull it out.



7.15.

**Transport
Screw**

1. R
e

move four transport screws (box wrench size 10 mm)

7.14. Tub Bellows Seal



1. R
e
m
o
v
e



2. Hold the transport screw and pull it out.



2. Remove the upper counterweight



7.17. Washing Group

1. Remove the connector that is connected to the motor.



7.16. Upper Counterweight

1. Remove two screws fixing the upper counterweight by using box wrench size 13 mm.



2. Cut the five lead wire holders as shown the pictures.

a)



b)



c)



d)

3. Remove the four screws fixing the spring hanger sheet iron.



4. Remove the washing group as it is shown in the picture.

7.19. Belt

1. Remove the belt as it is shown the picture.



7.20. Driven Pulley

1. Remove the screw fixing driven pulley it is shown the picture (By using T40).



7.18. Shock Absorber PIN

1. Remove two pins fixing the shock absorber as shown in the picture.



2. Remove the driven pulley it is shown the picture.



7.21. Motor

1. Remove the four screws fastening the motor under the tub by using T40



2. Pull the motor up for disassembly.

7.23. Pressure Switch Hose Group

1. Remove screw fixing the pressure switch water reservoir.



2. Remove the tub exit with bellow hose with ball by using box wrench size 10 mm.



7.22. Tub Entrance with Bellow Hose

1. Remove the tub entrance with bellow hose.



7.24. Tub



1. R
e
m
o
v
e
t
w

enty four screws fixing tub using box wrench size 8 mm.

7.25. Drum

1. Remove the drum.

8.26 BLDC Card

1



Remove the bottom plate by tilting the machine

2



This is the only way to remove the card without removing the washer group

3

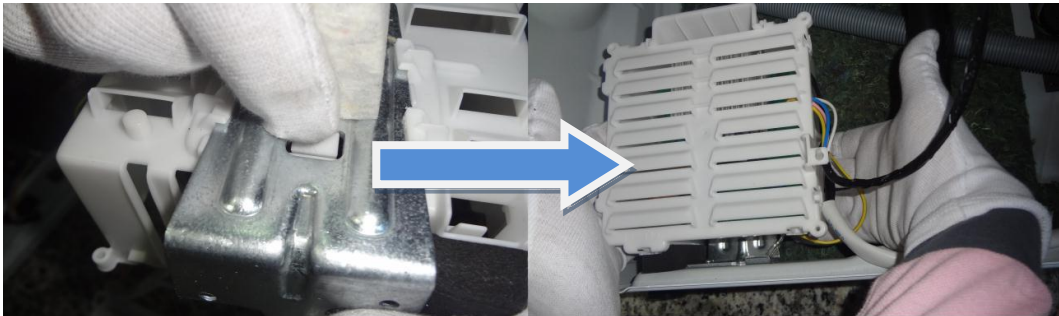

Remove the card by pressing the clip that placed behind (it could be seen on the first image) of the card and pushing the card.

4

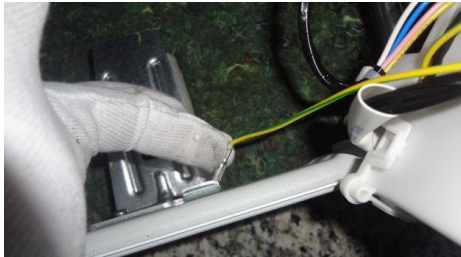

Remove the connection

5



Remove the cable group that belongs to card

6



Remove the card box that belongs to the pyrojet unit, by pressing the clips with screw driver.

7



Remove the card by pressing the clips around with screw driver.

8

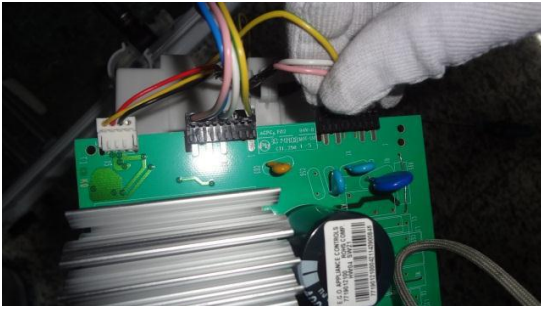

Remove the connections.

9



Remove the card completely

10



Remove the BLDC motor card fixing screws.

11



Remove the ground connection and make sure this connection is plugged during the assembly.

8. Component Specifications

8.1. Drain Pump

Drain pump is both a mechanical and electrical component which is used to drain water inside the washing machine. It has an synchronous motor inside. For better performance maintenance, pump filter should be cleaned regularly.



8.1.1. Technical Features

Nominal voltage	220 - 240 V
Nominal current	0.28 A ($\pm 10\%$)
Nominal power	37 W
Frequency	50 Hz
Resistor (coil)	130 Ω ($\pm 5\%$)
Water flow:	17 L/min(to 1 m height)
Thermal protector	YES

8.1.2. Checking of Component

Check the resistance value on the component with multimeter as shown in belows figures.

Resistance value should be between 125- 140 Ω



Checking the component

8.2. Resistance

Heating element (Resistance) is a component which is designed to regulate temperature of water inside the drum. It has three connections: Phase, notral and ground connections.



8.2.1. Technical Features

Kind of heating	Tubular heating element with NTC – sensor
Nominal voltage	230 V
Nominal power	2000 W ($\pm 5\%$)
Resistance	24,8 $\pm 5\%$ Ω
Thermal fuse	2 – sided

8.2.2. Checking of Component

Check the resistance value on the component with multimeter as shown in below pictures.



Checking the component

8.3. NTC

Component which sends signals to PCB about the water temperature inside the tub.

The Resistance (Ohm) value of the NTC decreases as the temperature increases.



8.3.1. Technical Features

Tem (°C)	R min (kΩ)	R max (kΩ)
-10	54,9	62,6
-5	43,0	48,6
0	33,9	38,1
5	27,0	30,1
10	21,6	23,9
15	17,4	19,1
20	14,1	15,4
25	11,5	12,5
30	9,4	10,2
35	7,8	8,3
40	6,4	6,9
45	5,4	5,7
50	4,5	4,7
55	3,8	3,9
60	3,2	3,3
65	2,7	2,8
70	2,3	2,4
75	1,9	2,0
80	1,7	1,8
85	1,4	1,5
90	1,2	1,3
95	1,1	1,1
100	0,9	1,0

NTC Tempure – Resistance Values

8.3.2. Checking of Component

Check the resistance value on the component with multimeter as shown in below pictures.



Checking the component

8.4. Valve

Valve is an electrical and mechanical component which is designed to take water from the network system into the washine machine. It is operated by PCB card.

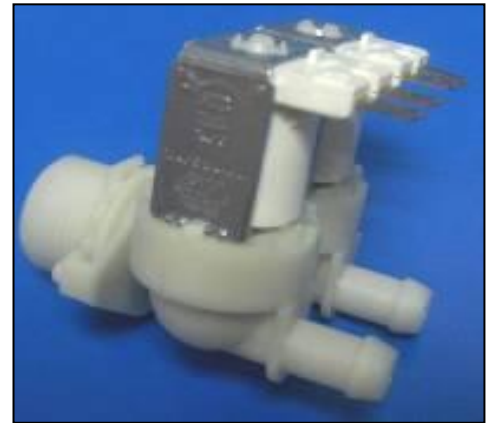

8.4.1. Technical Features

Nominal voltage	220 – 240 V
Nominal power	8 VA
Frequency	50-60 Hz
Rated flow:	7 lt/min ($\pm 15\%$)
Operating water pressure	0,0,3 – 1 Mpa

8.4.2. Checking of Component

Check the resistance value on the component with multimeter as shown in below pictures.

Valve water flow rate should be between 6 lt/min - 8 lt/min.

Each valve bobbin resistance values should be between 3,3 - 4.2 kohm .



Checking the component

8.5. Electronic Pressure Switch (EPS)

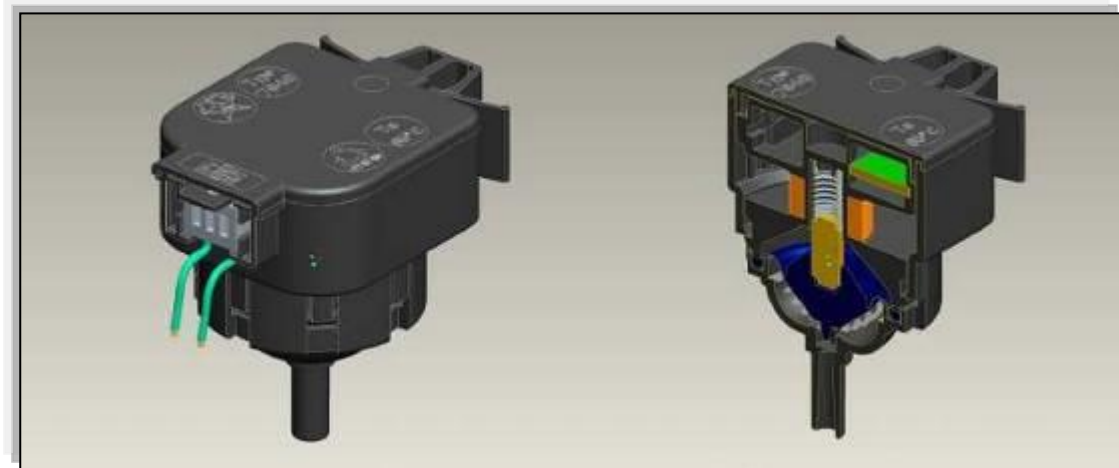

8.5.1. Technical Features

Electromagnetic field occurs as a result of the vibration of the membrane which is under pressure in the coil. The nucleus part is moved up and down by the electromagnetic field. The water level is regulated by the frequency which is controlled by the PCB and changes according to the movement of the nucleus part.

8.5.2. Checking of Component

1. Make sure there are no laundry in washing machine, tap is connected and opened, power cord is plugged. Put no detergent in drawer.
2. Bring program knob to position 1 (Cotton 90°C program)
3. Press start button.
4. Wait for water intake step to finish. You can recognise it by listening the water sound or slightly opening and observing detergent drawer.
5. As soon as water intake is over turn program knob to position 0 (Off position)
6. Check water level from door glass. The water level should be just below door glass as seen in the picture below: (There is a %10 tolerance with this level)



9.7. Motor

The washing machine has an asynchronous motor. It is controlled by the PCB. It is essential to check the motor for correct diagnosis and quick servicing. In the below picture, socket points on the motor is shown to measure with multi meter.



UNIVERSAL MOTOR

BLDC MOTOR

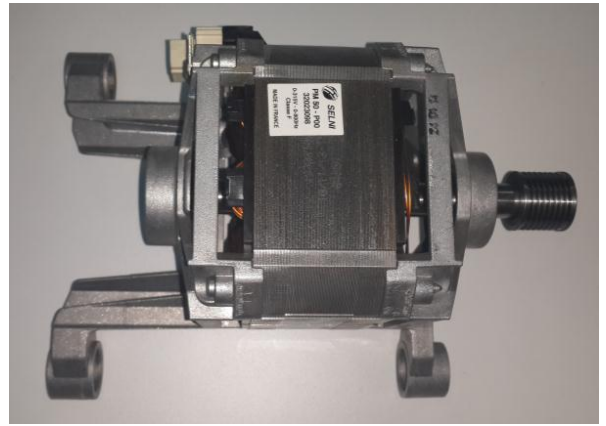

Motor

3 phase brushless DC Motor.

Ferrite Magnet

Stator resistance (phase- Neutral) $2,38 \pm 7\% \Omega$

Motor socket terminals

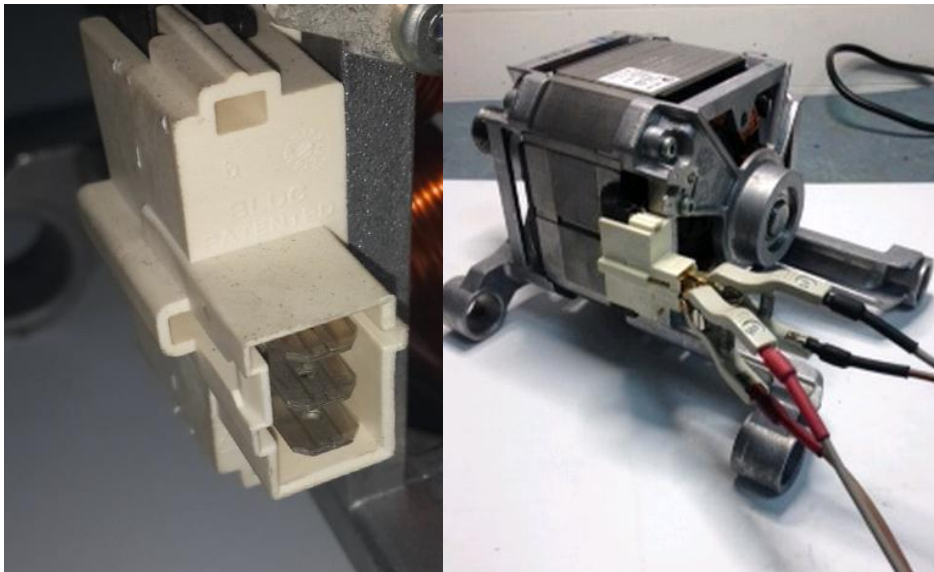

Measurement of resistance and inductance are done between the terminals.

8.7. Door Lock

Door lock is activated at the beginning of the program in order to prevent the door from opening. It can be unlocked approximately after 2 minutes of the program end. This time delay is caused by the PTC which is assembled in the door lock.

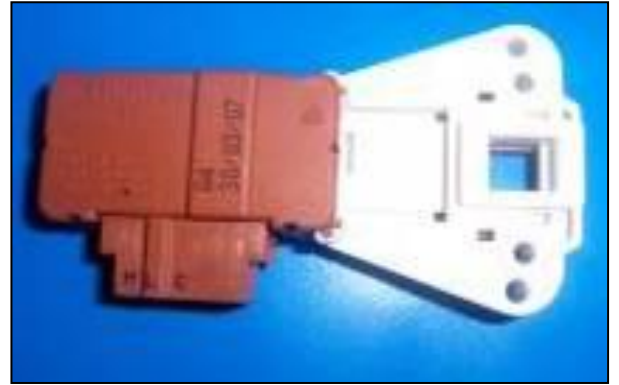

8.7.1. Technical Features

Lock Time (20 °C)	2" – 6"
Unlock Time (20 °C)	35" – 75"
Nominal voltage	220 V
Nominal current	16 (4) A

8.7.2. Checking of Component

Check the resistance value on the component with multi-meter as shown in below figures.

Resistance value on the PTC should be $1000 \Omega \pm 50\%$ at 25 °C. That resistance value can be measured from terminal 3-4 (See wiring diagram page 51 below).



9. Wiring Diagram

9.1. F4 TOUCH WASHER EGO BLDC ELECTRICAL CONNECTION DIAGRAM

