

The logo features the word "VESTEL" in a bold, white, sans-serif font. The text is centered on a red trapezoidal background that tapers to the left. This red shape is set against a dark grey trapezoidal background that also tapers to the left, creating a layered effect. A thin black horizontal line is positioned below the grey background.

**VESTEL**

# SERVICE MANUAL

# **TABLE OF CONTENTS**

	<b>PAGE</b>
<b>1. Specifications</b> .....	<b>3</b>
1.1. Product Specifications .....	3
1.2. Name Plate.....	3
<b>2. Installation Instructions</b> .....	<b>4</b>
2.1. Moving and Installing .....	4
2.2. Detergent Box Group.....	5
<b>3. Operating Instructions</b> .....	<b>6</b>
5.1. LCD Screen, Function Buttons & Knobs.....	6
5.2. Program List .....	6
5.3. Program Details.....	7
5.5. Child Lock.....	8
<b>4. Test Mode</b> .....	<b>9</b>
6.1. Autotest.....	9
<b>5. Service Mode</b> .....	<b>11</b>
5.1. Service Autotest.....	11
5.2. Failure Codes.....	12
<b>6. Troubleshooting Guide</b> .....	<b>12</b>
<b>7. Disassembly and Assembly Instructions</b> .....	<b>14</b>
7.1. Top Plate.....	14
7.2. Door.....	14
7.3. Tub Bellows Seal.....	16
7.4. Detergent Drawer.....	16
7.5. Control Panel.....	16
7.6. Kick Plate.....	18
7.7. Front Panel.....	18
7.8. Upper Support Bracket.....	20
7.9. Detergent Drawer Housing.....	20
7.10. Power Cable Group and Parazit Filter.....	21
7.11. Electronic Pressure Switch (EPS).....	22
7.12. Door Lock.....	22
7.13. Pump Motor.....	22
7.14. Front Counterweight.....	23
7.15. Heater.....	23
7.16. Tub Bellows Seal.....	24
7.17. Transport Screw.....	24
7.18. Upper Counterweight.....	25
7.19. Washing Group.....	25
7.20. Shock Absorber PIN.....	26
7.21. Belt.....	26
7.22. Driven Pulley.....	26
7.23. Motor.....	26
7.24. Tub Entrance with Bellow Hose.....	27
7.25. Pressure Switch Hose Group.....	27
7.26. Tub.....	27
7.27. Drum.....	27
<b>8. Component Specifications</b> .....	<b>28</b>
8.1. Drain Pump.....	28
8.3. Resistance.....	30
8.4. NTC.....	32
8.5. Valve.....	34
8.6. Electronic Pressure Switch (EPS).....	36
8.7. Motor.....	37
8.8. Door Lock.....	40
<b>9. Wiring Diagram</b> .....	<b>42</b>
9.1. Wiring Diagram NA-127VB3 and NA-147VB3.....	42

# 1. Specifications

## 1.1. Product Specifications

		42 lt
Product Type		R Serisi
Capacity		5 kg
Max Spin Speed (r/min)		400 – 500 600 – 800 - 1000
Energy Consumption		A+
Control Panel		R1 – R2
Wash Programs		15 settings
Dimensions	Height	84,5 cm
	Width	59,7 cm
	Depth	49,7 cm
Other Features		Child Lock
		Delay Time

## 1.2. Name Plate

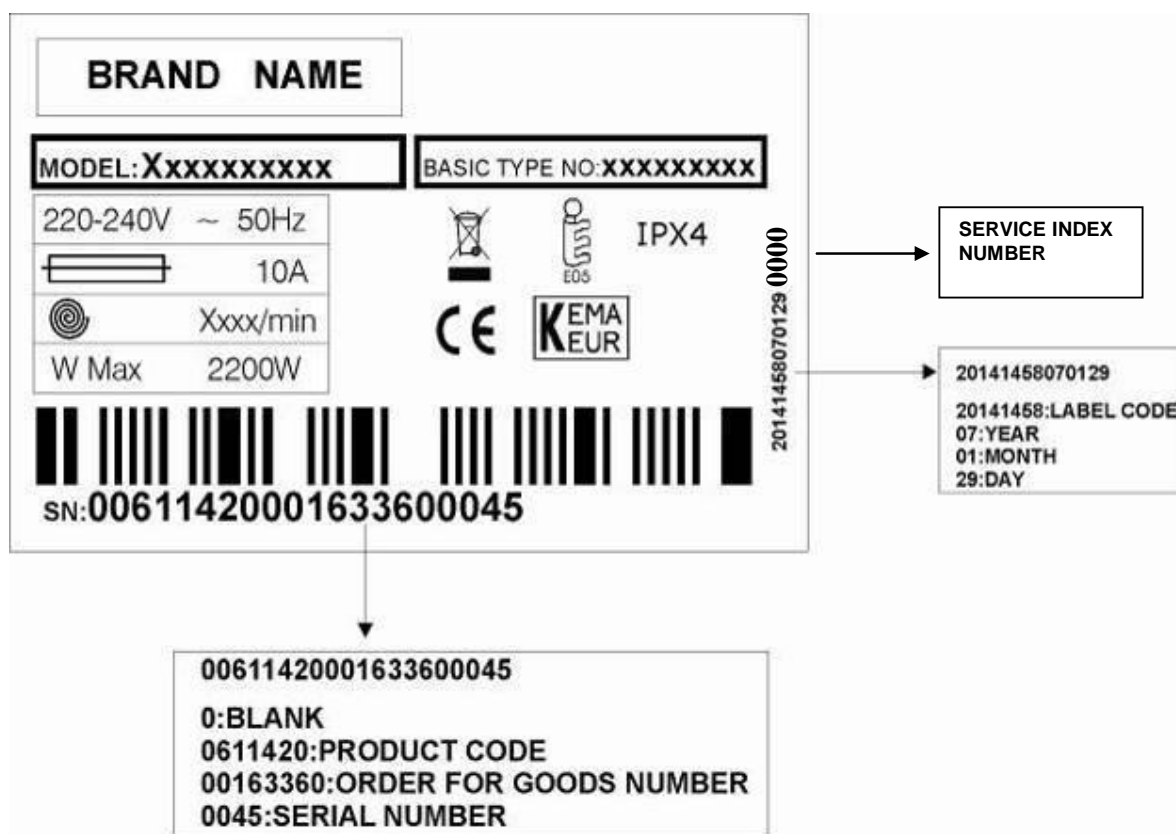

## 2. Installation Instructions

### 2.1. Moving and Installing

#### 2.1.1. Removal of Transportation Screw

1. Transportation screws, which are located at the back side of the machine, must be removed before running the machine.
2. Loosen the screws by turning them anticlockwise with a suitable spanner.

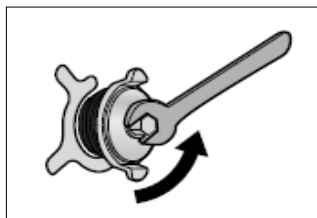

4. The holes where the transport screws have been removed should be covered with the plastic transport caps found in the accessories bag.

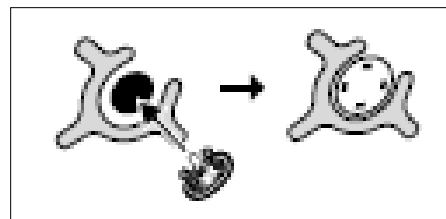

3. Pull out the screws and rubber washers.

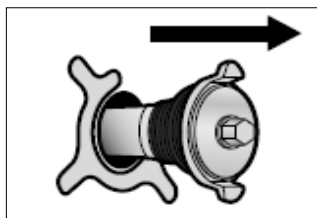

5. The transportation screws that have been removed from the machine must be re-used in any future transporting of the machine.

#### 2.1.2. Foot Adjustment

1. Do not install machine on rugs or similar surfaces.
2. For machine to work silently and without any vibration, it should be installed on a flat, non-slippery firm surface. Any suspended floor must be suitably strengthened.
3. You can adjust the level of machine using its feet.
4. First, loosen the plastic adjustment nut away from the cabinet base.

5. Change the level by adjusting the feet upwards or downwards.
6. After level has been reached, tighten the plastic adjustment nut again by rotating it upwards against the base of the cabinet.
7. Never put cartons, wooden blocks or similar materials under the machine to balance irregularities of the floor.

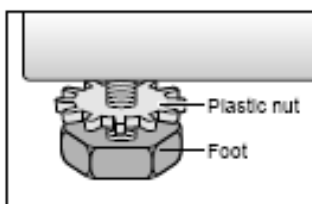

#### 2.1.3. Electrical Connection

1. Washing machine requires a 50Hz supply of 220-240Volts.
2. A special earthed plug has been attached to the supply cord of washing machine. This plug must be fitted to an earthed socket. The fuse value fitted to this plug should be 13 amps. If you have any doubts about electrical supply, consult a qualified electrician.

**THIS APPLIANCE MUST BE EARTHED.**  
**Insert the machine's plug to a grounded socket which you can easily reach.**

### 2.1.4. Water Supply Connection

1. Washing machine is supplied with a single (cold) water inlet.
2. To prevent leakage from the connection joints, a rubber washer is included in the hose packing. Fit this washer at the end of water inlet hose on the tap side.
3. Connect the hose to the water inlet valve. Tighten the plastic connector by hand. Please call a qualified plumber if you are unsure about this.
4. Water pressure of 0,1-1 MPa from tap will enable machine to work more efficiently.(0,1 MPa pressure means water flow of more than 8 litres in 1 minute from a fully opened tap)

### 2.1.5. Drain Connection

1. Make sure that water inlet hoses are not folded, twisted, crushed or stretched.
2. The drain hose should be mounted at a minimum height of 60 cm, and a maximum height of 100 cm from the floor.

5. After connection is complete, check for leakage by turning on tap completely.
6. Make sure that water inlet hoses can not become folded, damaged, stretched or crushed when the washing machine is in its final position.
7. Mount the water inlet hose to a 3/4" threaded water tap.

3. The end of the drain hose can be connected directly to a drainage stand-pipe or alternatively to a specific connection point designed for that purpose on the waste outlet of a sink unit.
4. Do not extend the drain hose or guarantee will be invalidated.

## 2.2. Detergent Box Group

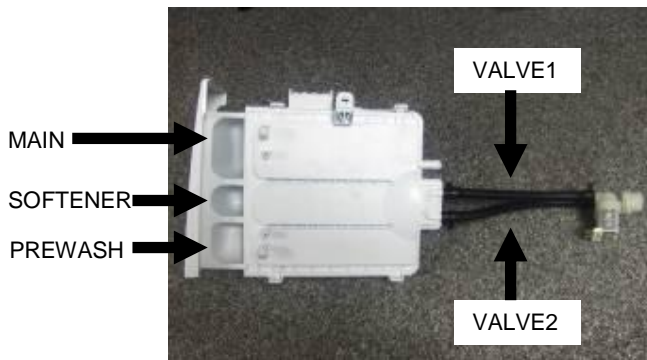

PREWASH = WATER ENTRY VALVE 1  
MAIN = WATER ENTRY VALVE 2  
SOFTENER = WATER ENTRY VALVE 1 + VALVE 2

### 3. Operating Instructions

#### 3.1. R Kontrol Panel

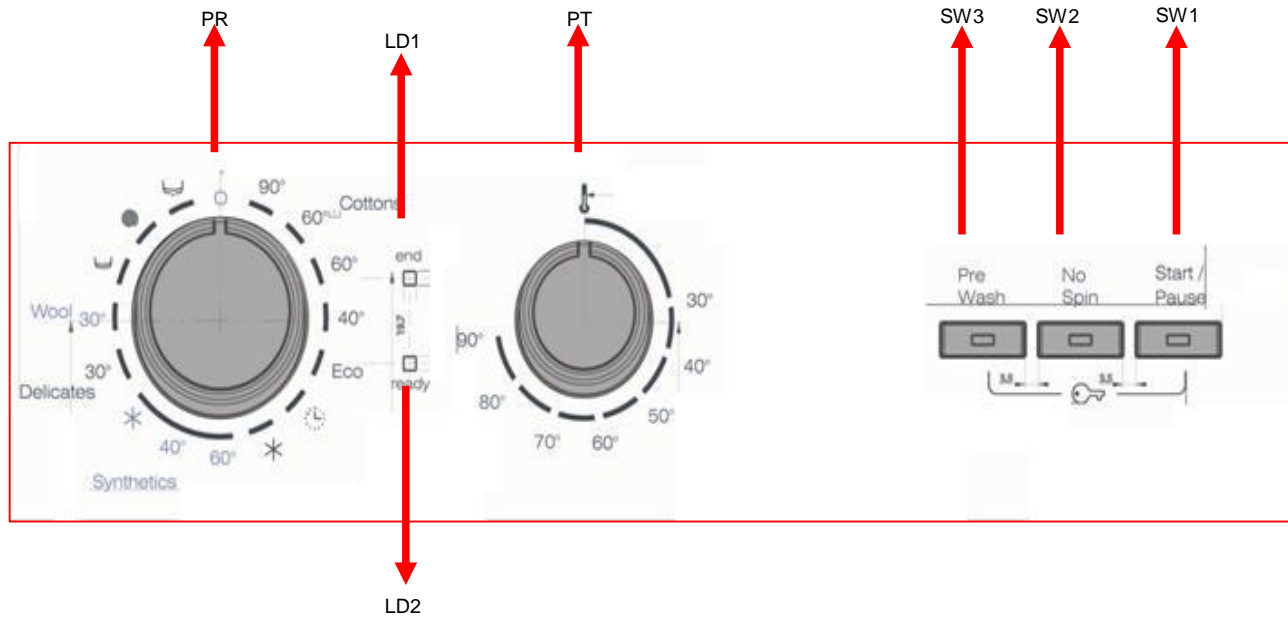

PR	Program selector 16 programs with ON/OFF.
PT	Temperature Adj. Knob
SW1	Switch 1, Start / Pause
SW2	Switch 2, No Spin
SW3	Switch 3, Easy Ironing
LD1	End Led
LD2	Start/ Pause Led

#### 3.2. Program List

Knob Position	Program
Pos1	COTTON90°C
Pos2	COTTON 60°C PRW
Pos3	COTTON 60°C
Pos4	COTTON 40°C
Pos5	ECO WASH
Pos6	QUICK WASH
Pos7	COTTON COLD
Pos8	SYNTHETICS 60°C
Pos9	SYNTHETICS 40°C
Pos10	SYNTHETICS COLD
Pos11	DELICATE 30°C
Pos12	WOOL 30°C
Pos13	RINSE
Pos14	SPIN
Pos15	DRAIN

### 3.3. Program Details

#### Program Details for 42 lt

42lt	Total time (min)	Max. T(°C)	Total Water Consumption (lt)	Max.energy (kwh)	Number of Rinse
COTTON90°C	155	83	75	1,96	3
COTTON 60°C PRW	140	57	74	0,89	3
COTTON 60°C	190	57	43	0,85	2
COTTON 40°C	180	40	45	0,82	2
ECO WASH	80	40	43	0,39	2
QUICK WASH	30	25	40	0,16	2
COTTON COLD	110	WIT	56	0,17	3
SYNTHETICS 60°C	84	55	45	0,95	2
SYNTHETICS 40°C	65	40	45	0,53	2
SYNTHETICS COLD	72	WIT	45	0,12	2
DELICATE 30°C	70	30	56	0,34	3
WOOL 30°C	73	29	52	0,29	3
RINSE	28	WIT	41	0,04	3
SPIN	10	-	-	0,02	-
DRAIN	2	-	-	0,01	-

\* : Programme duration ,Energy and Water Consumption are given for the cycles for programmes are started in set temperature.

WIT : Water Inlet Temperature

- : Programmes do not take water

- Temperature may vary depending on the heating time
- Durations may vary according to wash load (weight and type), tap water and ambient temperature and selected extra functions.

### 3.5. Child Lock

Press the start-pause and second function button for 3-4 seconds to activate child lock.

Press the start-pause and second function button for 3-4 seconds to deactivate child lock.



#### Activation Indication

1. The symbol (I6) makes fast blink for indication and is then fix on.

#### Child lock during the programme

1. Machine does not respond to any pressing of buttons or changing position of programme knob but option icon makes fast blink to evoke the user.

#### In end condition

1. When cycle is finished child lock is automatically deactivated.

#### Deactivation Indication

1. Option icon makes fast blink and is then off.

#### In Error Mode

1. Child lock will be automatically deactivated when error is detected except NTC (E05) and Voltage (E09) errors.

When E05 and E09 is detected, the child lock will be deactivated at the end of the program or the user will be able to deactivate it. On other hand, if the user brings the programme knob to zero and then any position during these two error modes, firstly it will show child lock active indication and then the error indication and it will continue the cycle.



## 4. Test Mode

### 4.1. Autotest

*\* This test is for quick checking of the product. You can not see the failure codes.*

1. Turn the program knob to third program.



4. Release the function button. The button light will be on.



2. Press the first function button.



5. Press the first function button again.



3. While pressing the first function button, turn the program knob to second program.



6. While pressing the first function button, turn the program knob to first program. Release the function button and the autotest starts.

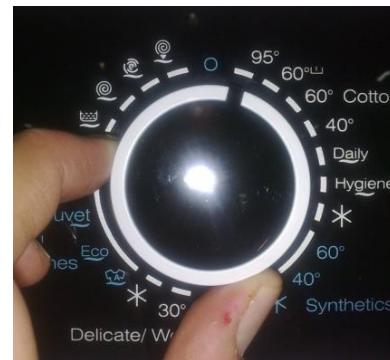

7. When the first function button light flashes, press the button again. Autotest will enter the second phase.

AUTOTEST													
Time in seconds (to be adjusted)	5	10	15	20	25	30	35	40	45	50	55	60	65
Entering autotest	█	█	█	█	█	█	█	█	█	█	█	█	█
Changing power to 220 50Hz	█	█	█	█	█	█	█	█	█	█	█	█	█
Main Voltage 50 Hz	█	█	█	█	█	█	█	█	█	█	█	█	█
Door Lock Powered (Depends on door lock)	█	█	█	█	█	█	█	█	█	█	█	█	█
Motor Ramp to max spin (max. is 15 sec.)	█	█	█	█	█	█	█	█	█	█	█	█	█
Time until motor is stopped (Depends on the motor stop time)	█	█	█	█	█	█	█	█	█	█	█	█	█
Motor Preferred Run (Direction to Right)	█	█	█	█	█	█	█	█	█	█	█	█	█
Motor Inverse Run (Direction to Left)	█	█	█	█	█	█	█	█	█	█	█	█	█
EV1 (flowrate dependent of washer)	█	█	█	█	█	█	█	█	█	█	█	█	█
EV2 (flowrate dependent of washer)	█	█	█	█	█	█	█	█	█	█	█	█	█
Test stopped until option 1 is pressed (symbol blinking)	█	█	█	█	█	█	█	█	█	█	█	█	█
EV1 + EV2 valves up to autotest level frequency (Depends on the water level) (if machine is a hot water one, take water from Hot Valve)	█	█	█	█	█	█	█	█	█	█	█	█	█
NTC check	█	█	█	█	█	█	█	█	█	█	█	█	█
Heather resistance	█	█	█	█	█	█	█	█	█	█	█	█	█
Pump	█	█	█	█	█	█	█	█	█	█	█	█	█
Twin Jet	█	█	█	█	█	█	█	█	█	█	█	█	█
EPS measurement	█	█	█	█	█	█	█	█	█	█	█	█	█
End visualization	█	█	█	█	█	█	█	█	█	█	█	█	█

**Ntc detection** : Software will detect NTC's resistance value and will check if the temperature is between 5°C < Temperature detected < 40°C. If it is inside the range, heating step will be done.  
 If temperature value is outside the range, then it means NTC is detecting the temperature in a wrong way and heating step will be skipped.

**EPS measurement**: It checks the EPS and if it OK, it continues the autotest; if it is Not OK then cancel the Autotest and go to the selection mode. Also if any frequency can not be detected, then it means there is problem with connection or EPS, so it gives E10 which is EPS error and cancels the autotest & goes to the selection mode.

## 5. Service Mode

### 5.1. Service Autotest

End users can only see E1-E2-E3-E4. During service autotest, other failures can be seen.

1. Set program knob at position 3 after selection spin speed to max.
2. While pressing the T °C (Sw2) button, keeping T °C (Sw2) button pushed, turn program knob to position 2, release T °C (Sw2) button change position of the third to second, and remove the T °C button within 1 second.

	Selector Position 1	Selector Position 2	Selector Position 3
	Result	Result	Result
	HEATER ON	PUMP ON	TEST PROGRAM ON
Comments :	When entering in service test, door will be locked.		Test is over Door will be unlocked, machine will go to ENS state.

The test steps are as below ;

#### Step 1 :

Selector Position 1 will be "HEATER ON"

Before heating it should take water till first level frequency then start heating.

Heater will be on max. 8 minutes after this 8 minutes if the temp. doesn't change more than 2 ° C then it will give NTC failure. (E05).

Or if the NTC connection is broken then it should give again E05 NTC failure.

At the end of heating, "SAU" visualization should make slow blink to indicate that the step is over.

Note : If user changes the selector position, machine will do what is defined for the new selected position.

#### Step 2 :

Selector Position 2 will be "PUMP ON"

Temperature will be measured, if it is higher than 50 ° C, it should take 60 sec. cooling water, and then make "Drain + 5 sec."

At the end of pump activation, "SAU" visualization should make slow blink to indicate that the step is over.

#### Step 3 :

Selector Position 3 will be 15 minutes test program.

So machine will make exactly the same algorithm of 15 minutes test program.

At the end of 15 minutes test program "END" is visualized and door is unlocked. During test pressing other buttons makes no change.

LD1 Start / Pause button Led → ON

LD6 Wash Phase Led → Off

LD7 Rinse Phase Led → Off

LD8 Spin Phase Led → Off

LD9 Door Lock Led → When the door is unlocked it will be off

LD2, LD3, LD4 → Off

Display → "END"

## 5.2. Failure Codes

Error Indication	Error Number	Indication For User	Indication For Service
		Yes/No	Yes/No
Door is not locked	E01	Yes	Yes
Door is unlocked during programme	E01	Yes	Yes
Lack of water	E02	Yes	Yes
Pump failure	E03	Yes	Yes
Overflow	E04	Yes	Yes
NTC or Heater Failure	E05	No	Yes
Motor Failure - 1 (Tachometer open-short circuit or motor connector is disconnected)	E06	No	Yes
Motor Failure - 2 (triac short circuit)	E08	No	Yes
Electronic Pressure Sensor	E10	No	Yes

## 6. Troubleshooting Guide

All repairs which must be done on the machine should be done by authorized agents only. When a repair is required for machine or you are unable to eliminate the failure with the help of the information given below:

- Unplug the machine.
- Close the water tap.

FAILURE	PROBABLE CAUSE	METHODS OF ELIMINATION
<b>Machine does not operate.</b>	It is unplugged.	Insert the plug into the socket.
	Fuse is defective.	Change fuse.
	Start / Pause button has not been pressed.	Press the start / pause button.
	The program knob is in 0 (off) status.	Bring the program knob on the desired status.
	The door is not shut properly.	Shut the door properly. You should hear the click.
<b>Machine does not receive water.</b>	Child lock is active.	See page 9.
	Water tap is closed.	Open water tap.
	The water inlet hose may be bent.	Check the water inlet hose.
	The water inlet hose is obstructed.	Clean the filters of water inlet hose.
	The water inlet filter is obstructed.	Clean the valve inlet filters.
<b>Machine is not draining water.</b>	The door is not shut properly.	Shut the door properly. You should hear the click.
	The drain hose is obstructed or bent.	Check the drain hose.
	The pump filter is obstructed.	Clean the pump filter.
<b>Machine is vibrating.</b>	The clothes are not placed inside the machine in a well-balanced manner.	Spread the clothes inside the machine in an orderly and well-balanced manner.
	The feet of machine are not adjusted.	Adjust the feet.
	Transportation screws are not removed.	Remove transportation screws.
	There is a small amount of clothes in the device.	It does not prevent operation of the machine.
	Excessive amount of clothes are filled in the machine or the clothes are not placed in a well-balanced manner.	Do not exceed the recommended quantity of clothes and spared clothes in the machine in a well-balanced manner.

<b>FAILURE</b>	<b>PROBABLE CAUSE</b>	<b>METHODS OF ELIMINATION</b>
<b>Excessive foam in the detergent drawer</b>	Too much detergent has been used.	Press the start/pause button. In order to stop the foam, dilute one table-spoon of softener in half liter of water and pour it in the detergent drawer. Press the start/pause button after 5-10 minutes. Arrange the amount of the detergent properly in the next washing process.
	Wrong detergent has been used.	Use only the detergents produced for full automatic machines.
<b>The washing result is bad.</b>	Laundry too dirty for the program you have selected.	Select a suitable program.
	The amount of detergent used is not sufficient.	Use more detergent according to the detergent.
<b>The washing result is not good.</b>	Clothes exceeding the maximum capacity has been filled in machine.	Put the clothes in machine in a manner not to exceed its maximum capacity.
	Water may be hard.	Use the amount of detergent according to the declaration of the detergent producer.
	Distribution of the clothes in machine is not well-balanced.	Spread the clothes inside the machine in an orderly and well-balanced manner.
<b>The water is seen in the drum during washing.</b>	No failure. The water is at the lower part of the drum.	
<b>There are residues of detergent on the clothes.</b>	The pieces of some detergents which do not dissolve in water may stick to clothes as white stains.	By calibrating machine for "Rinsing" program, make an additional rinsing or eliminate the stains After drying with the help of a brush.
<b>There are grey stains on the clothes.</b>	These stains may be caused by oil, cream or ointment.	In the next washing operation, use the maximum detergent amount declared by the detergent producer.
<b>The spinning process is not done or starts with delay.</b>	No failure. The unbalanced load control works in that way.	The unbalanced load control system will try to distribute clothes in a homogenous manner. After clothes are distributed, passage to spinning process will be realized. In the next washing process, place clothes into the machine in a well-balanced manner.

## 7. Disassembly and Assembly Instructions

### 7.1. Top Plate

1. Remove two screws that fix the top-plate at the back.



2. Push the top-plate back and pull it up.

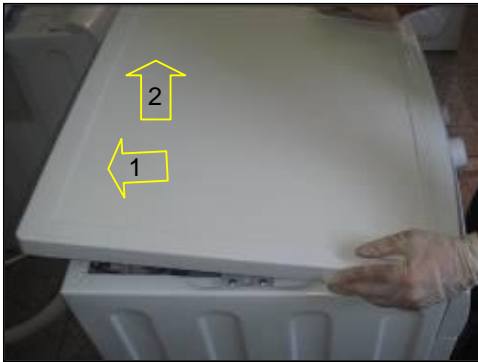

2. Pull the door up.



3. Remove screws that fix the door group.



### 7.2. Door

1. Remove two screws that fix the door. (by using the T25)



4. Put the door outside plastic with helping screwdriver as it is shown in the picture.

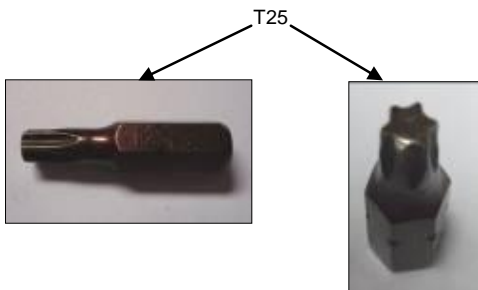

5. Remove the door inside plastic as it is shown in the picture.



8. Remove the door handle pin as it is shown in the picture.



6. Remove six screws that fix the door hinge as it is shown in the picture.



7. Remove the door handle as it is shown in the picture.



### 7.3. Tub Bellows Seal

1. First remove the spring wire fixing the tub bellows seal by using the small size screw driver. Pull the tub bellows seal as it is shown in the picture.



2. Remove the tub bellows seal-body fixing spring.



### 7.4. Detergent Drawer

1. Remove the detergent drawer and pull it up carefully



### 7.5. Control Panel

1. Remove the screw which fix the control panel to the front panel.





2. Remove three screws fixing the control panel.



3. Pull the control panel up.



4. Remove connectors as it is shown in the picture.



5. Remove the lcd communication cable as it is shown in the picture.

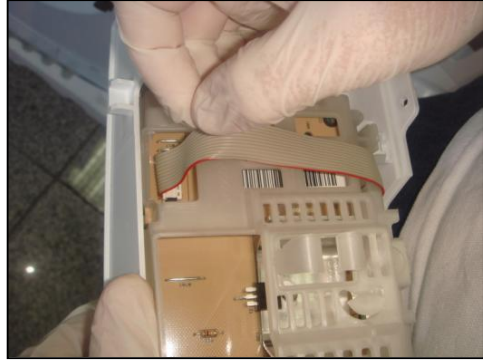

6. Remove electronic card cover as it is shown in the picture by using small screw driver.



7. Remove lcd electronic card as it is shown in the picture.

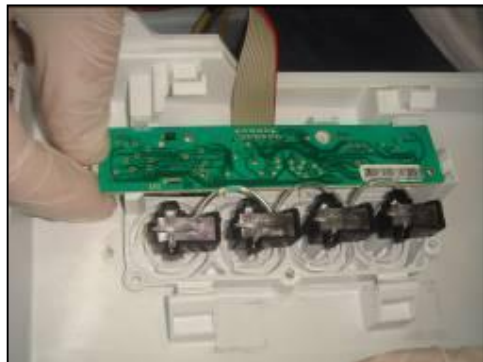

## 7.6. Kick Plate

1. Remove the right part of the kickplate as it is shown in the picture.



2. Remove two screws fixing the kickplate.



3. Pull the kickplate left and push it down.



## 7.7. Front Panel

1. Remove two screws fixing the front panel at the bottom as it is shown in the picture by using T25



2. Remove two screws fixing the door lock as it is shown in the pictures.



3. Remove the tub bellows seal as it is shown in the pictures.



5. Remove the front panel as it is shown in the pictures.



4. Remove two screws fixing front panel at the upper as it is shown in the picture.



## 7.8. Upper Support Bracket

1. Remove two screws fixing the body group at the front as it is shown in the picture.



2. Remove two screws fixing the body group at the upper as it is shown in the picture.



3. Remove detergent drawer group two clips fixing the upper support bracket as it is shown in the picture.



## 7.9. Detergent Drawer Housing

1. Remove the tub seal clamp by using the pliers, which is attached to the detergent drawer housing.



2. Remove the four connectors that is connected to the feed valve as it is shown in the picture.



3. Turn the feed valve counter clockwise slightly to remove.



4. Remove the detergent drawer screw.

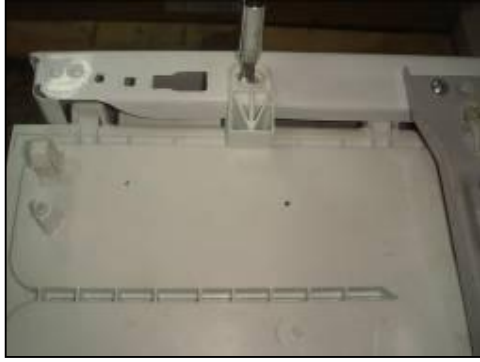

2. Remove two screws fixing the parasite filter.



5. Remove the detergent drawer housing assembly.

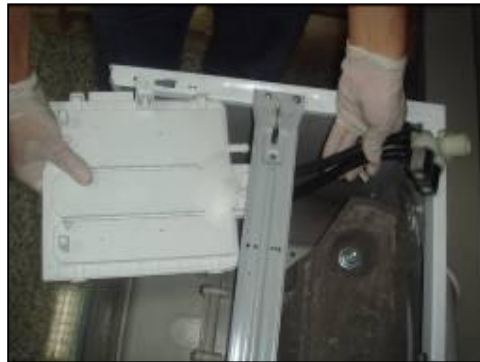

3. Pull the power cable group up as it is shown in the picture.



## 7.10. Power Cable Group and Parazit Filter

1. Remove the five connectors that is connected to the parasite filter.



4. Remove parasite filter fixing body group as it is shown in the picture.



### 7.11. Electronic Pressure Switch (EPS)

1. Remove the connector that is connected to the EPS.



2. Pull the EPS upward to remove as it is shown in the picture.

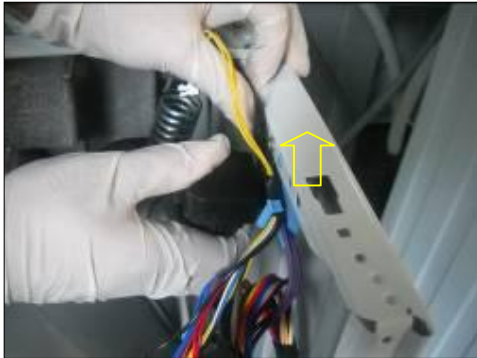

3. Remove the eps hose handcuffs and eps hose as it is shown in the picture.



### 7.12. Door Lock

1. Remove the connector that is connected to the door lock.

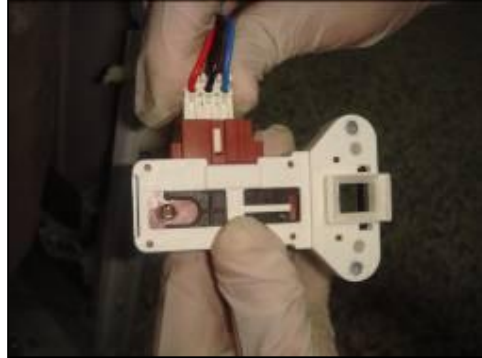

### 7.13. Pump Motor

1. Remove pipe clip that fixes the drain hose.



2. Remove pipe clip fixing the tub outlet hose.



3. Remove the connector that is connected to the pump motor.



2. Pull the counterweight back



4. Remove four screws fixing the pump motor.



## 7.15. Heater

1. Remove the four connectors that is connected to the heater.



## 7.14. Front Counterweight

1. Remove four screws fixing the front counterweight on the front. (Box wrench size 13 mm)



2. Remove one nut fixing the heater slightly (box wrench size 8 mm)



3. Hold the heater and pull it out.



## 7.17. Transport Screw

1. Remove four transport screws (box wrench size 10 mm)



## 7.16. Tub Bellows Seal

1. Remove the tub gasket clip by using small screwdriver.



2. Hold the transport screw and pull it out.



2. Hold the tub bellows seal and gasket-body fixing spring together, and pull them up.





## 7.18. Upper Counterweight

1. Remove two screws fixing the upper counterweight by using box wrench size 13 mm.



2. Remove the upper counterweight

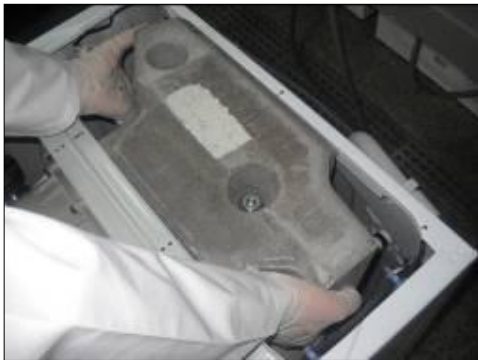

2. Cut the five lead wire holders as shown the pictures.

a)



b)



c)



d)



3. Remove the four screws fixing the spring hanger sheet iron.



## 7.19. Washing Group

1. Remove the connector that is connected to the motor.



4. Remove the washing group as it is shown in the picture.



## 7.20. Shock Absorber PIN

1. Remove two pins fixing the shock absorber as shown in the picture.



2. Remove the driven pulley it is shown the picture.



## 7.21. Belt

1. Remove the belt as it is shown the picture.



## 7.23. Motor

1. Remove the four screws fastening the motor under the tub by using T40



## 7.22. Driven Pulley

1. Remove the screw fixing driven pulley it is shown the picture (By using T40).



2. Pull the motor up for disassembly.

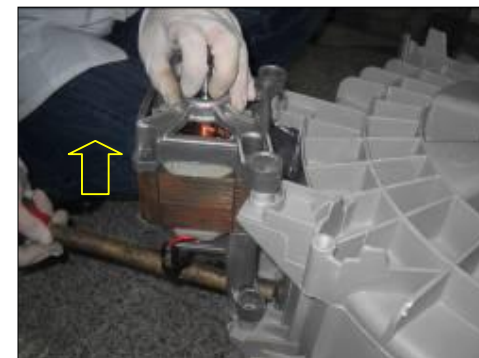

### 7.24. Tub Entrance with Bellow Hose

1. Remove the tub entrance with bellow hose.



### 7.26. Tub

1. Remove twenty four screws fixing tub using box wrench size 8 mm.



### 7.25. Pressure Switch Hose Group

1. Remove screw fixing the pressure switch water reservoir.



2. Remove the tub exit with bellow hose with ball by using box wrench size 10 mm.



### 7.27. Drum

1. Remove the drum.



## 8. Component Specifications

### 8.1. Drain Pump

Drain pump is both a mechanical and electrical component which is used to drain water inside the washing machine. It has an synchronous motor inside. For better performance maintenance, pump filter should be cleaned regularly.



#### 8.1.1. Technical Features

Nominal voltage	220 - 240 V
Nominal current	0.28 A ( $\pm 10\%$ )
Nominal power	37 W
Frequency	50 Hz
Resistor (coil)	130 $\Omega$ ( $\pm 5\%$ )
Water flow:	17 L/min(to 1 m height)
Thermal protector	YES

#### 8.1.2. Checking of Component

Check the resistance value on the component with multimeter as shown in belows figures.

Resistance value should be between 125- 140  $\Omega$



Checking the component

### 8.1.3. Component Controlling By Connection Measurement

You can determine the ohm value by measuring from the blue cable and blue cable (refer wiring diagram at page 43) as shown in belows figure. Resistance value should be between 125- 140  $\Omega$

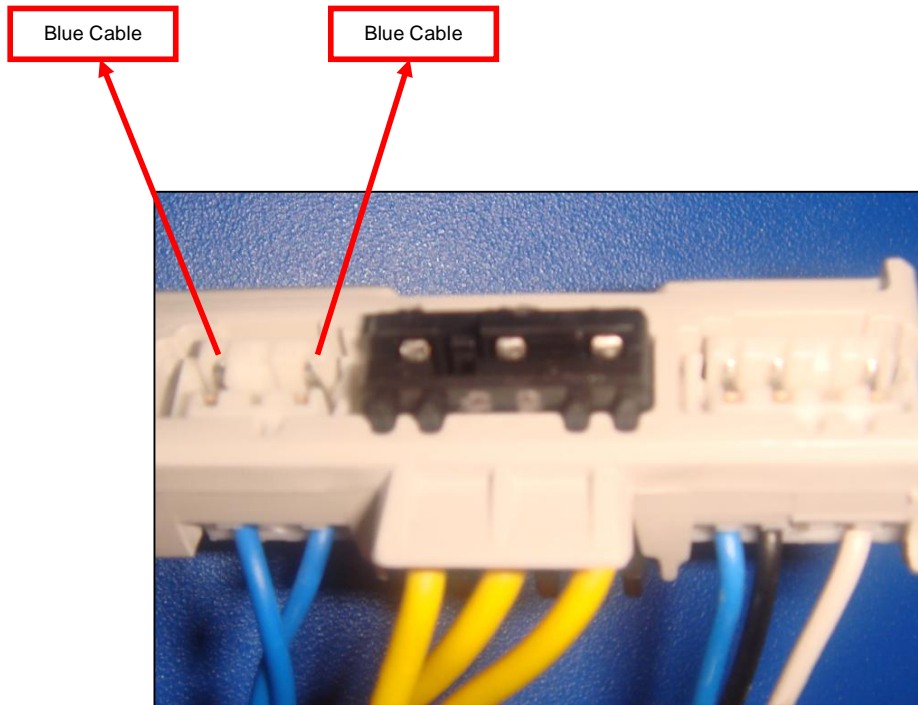

## 8.2. Resistance

Heating element (Resistance) is a component which is designed to regulate temperature of water inside the drum. It has three connections: Phase, notral and ground connections.



### 8.2.1. Technical Features

Kind of heating	Tubular heating element with NTC – sensor
Nominal voltage	230 V
Nominal power	2000 W ( $\pm 5\%$ )
Resistance	$24,8 \pm 5\% \Omega$ (for NA-127VB3 and NA-147VB3)
Thermal fuse	2 – sided

### 8.2.2. Checking of Component

Check the resistance value on the component with multimeter as shown in below pictures.



Checking the component

### 8.2.3. Component Controlling By Connection Measurement

You can determine the ohm value by measuring from the grey cable and brown cable (refer wiring diagram at page 43) as shown in belows figures. Resistance value should be between 23- 27 Ohm.

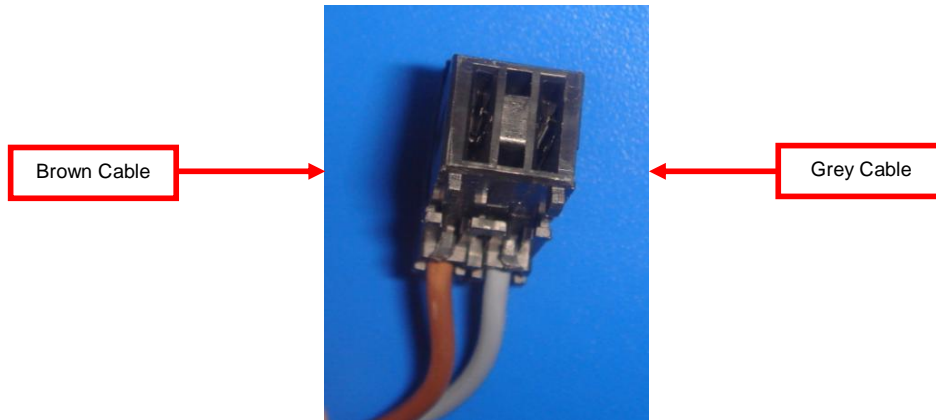

### 8.3. NTC

Component which sends signals to PCB about the water temperature inside the tub.

The Resistance (Ohm) value of the NTC decreases as the temperature increases.



#### 8.3.1. Technical Features

Tem (°C)	R min (kΩ)	R max (kΩ)
-10	54,9	62,6
-5	43,0	48,6
0	33,9	38,1
5	27,0	30,1
10	21,6	23,9
15	17,4	19,1
20	14,1	15,4
25	11,5	12,5
30	9,4	10,2
35	7,8	8,3
40	6,4	6,9
45	5,4	5,7
50	4,5	4,7
55	3,8	3,9
60	3,2	3,3
65	2,7	2,8
70	2,3	2,4
75	1,9	2,0
80	1,7	1,8
85	1,4	1,5
90	1,2	1,3
95	1,1	1,1
100	0,9	1,0

NTC Tempure – Resistance Values

#### 8.3.2. Checking of Component

Check the resistance value on the component with multimeter as shown in below pictures.



Checking the component



### 8.3.3. Component Controlling By Connection Measurement

You can determine the ohm value by measuring from the black cable and black cable (refer wiring diagram at page 43) as shown in belows figure. NTC resistance value varies depending on temperature.

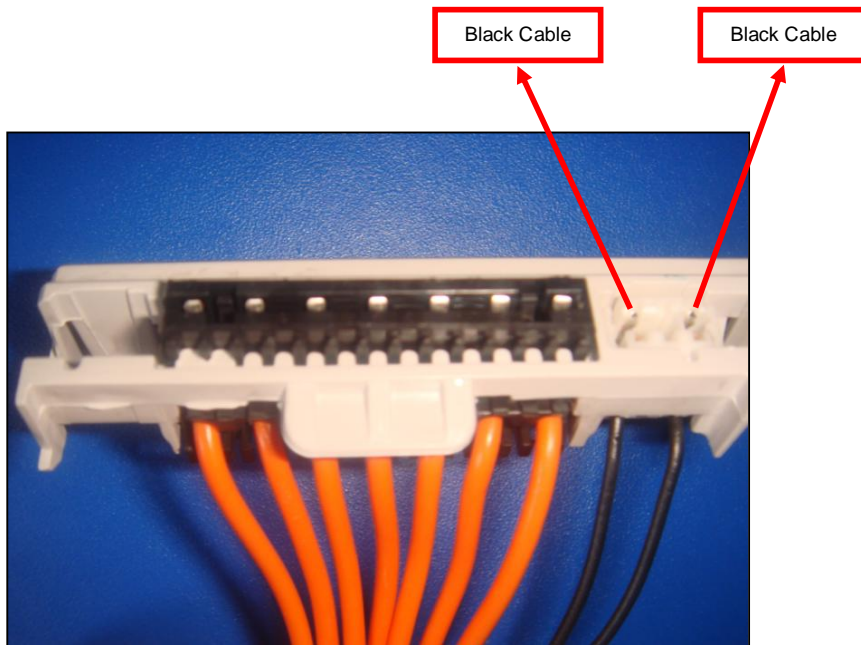

## 8.4. Valve

Valve is an electrical and mechanical component which is designed to take water from the network system into the washine machine. It is operated by PCB card.

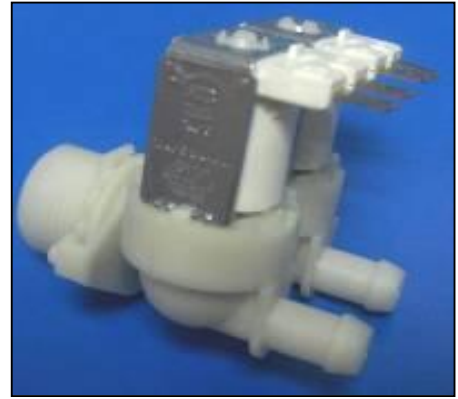

### 8.4.1. Technical Features

Nominal voltage	220 – 240 V
Nominal power	8 VA
Frequency	50-60 Hz
Rated flow:	7 lt/min ( $\pm 15\%$ )
Operating water pressure	0,0,3 – 1 Mpa

### 8.4.2. Checking of Component

Check the resistance value on the component with multimeter as shown in below pictures.

Valve water flow rate should be between 6 lt/min - 8 lt/min.

Each valve bobbin resistance values should be between 3,3 - 4.2 kohm .



Checking the component

### 8.4.3. Component Controlling By Connection Measurement

You can determine the ohm value of the main wash valve by measuring from the blue cable and white cable or the pre-wash valve by measuring from the black cable and white cable (refer wiring diagram at page 43) as shown in belows figure. Each valve bobbin resistance values should be between 3,3 - 4.2 kohm .

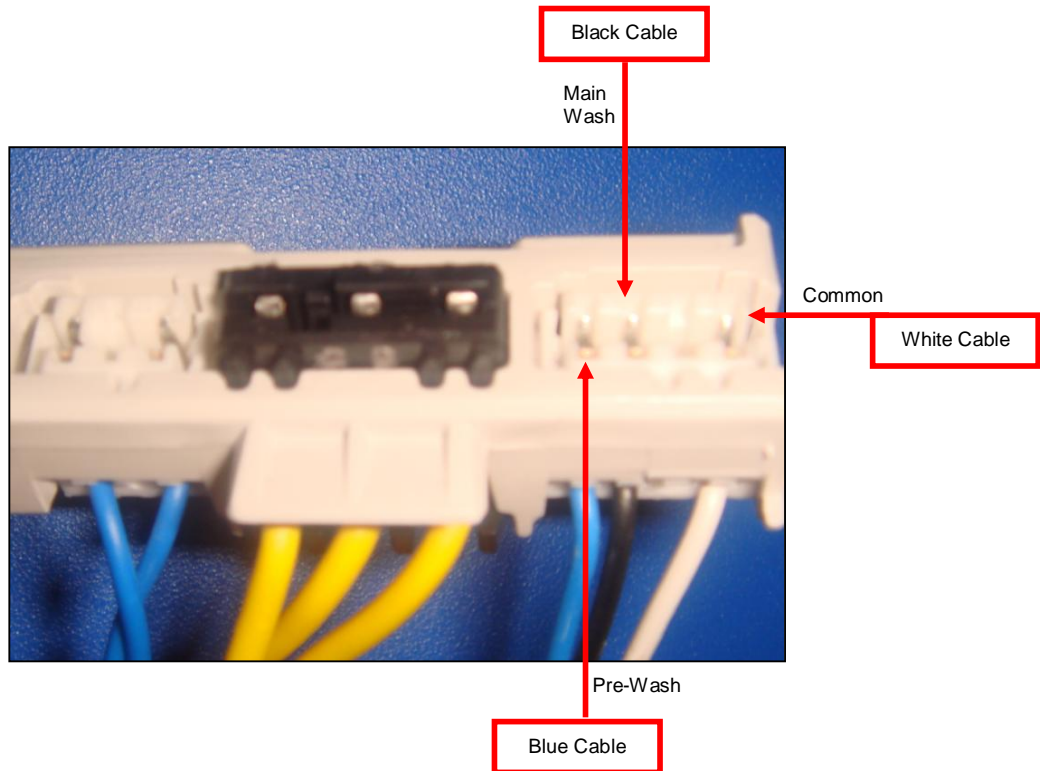

## 8.5. Electronic Pressure Switch (EPS)

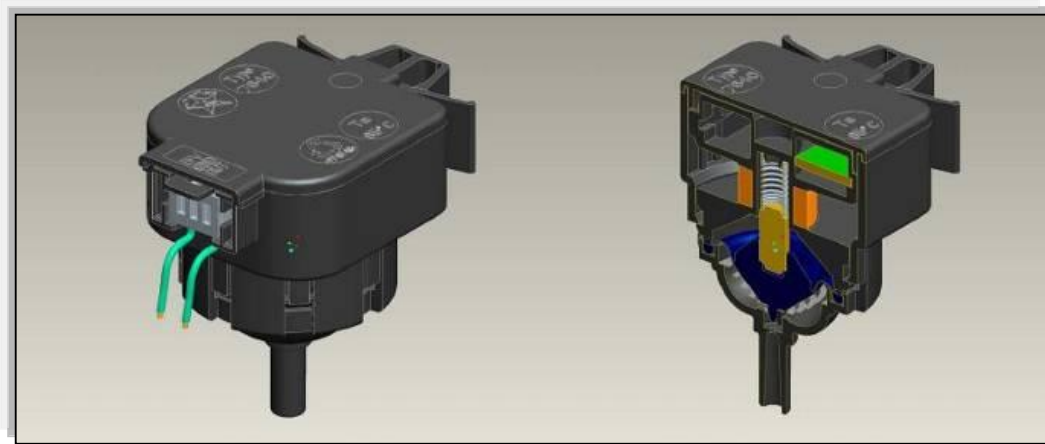

### 8.5.1. Technical Features

Electromagnetic field occurs as a result of the vibration of the membrane which is under pressure in the coil. The nucleus part is moved up and down by the electromagnetic field. The water level is regulated by the frequency which is controlled by the PCB and changes according to the movement of the nucleus part.

### 8.5.2. Checking of Component

1. Push the door lock slider with screwdriver.



6. Cut off the energy input when the water intake finishes and drum begins to rotate.

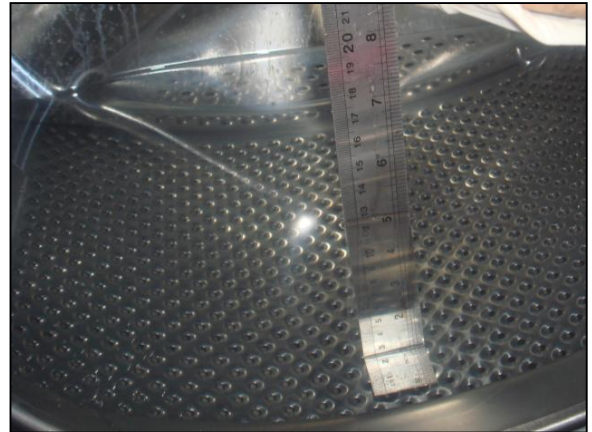

5. Select the 1st program and start the machine.



7. Check the water level inside the drum with ruler. It should be 10 cm  $\pm$  1.

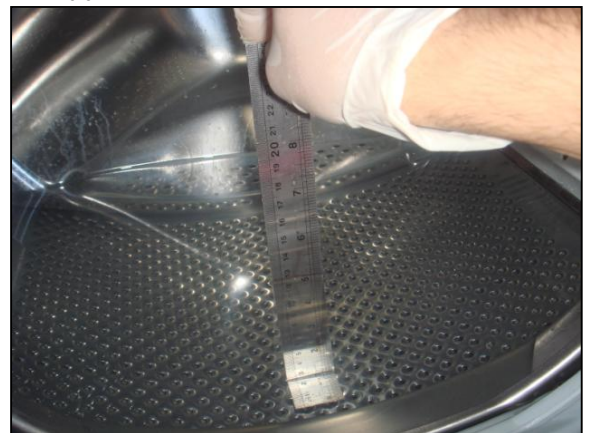

## 8.6. Motor

The washing machine has an asynchronous motor. It is controlled by the PCB.

It is essential to check the motor for correct diagnosis and quick servicing. In the below picture, socket points on the motor is shown to measure with multimeter.

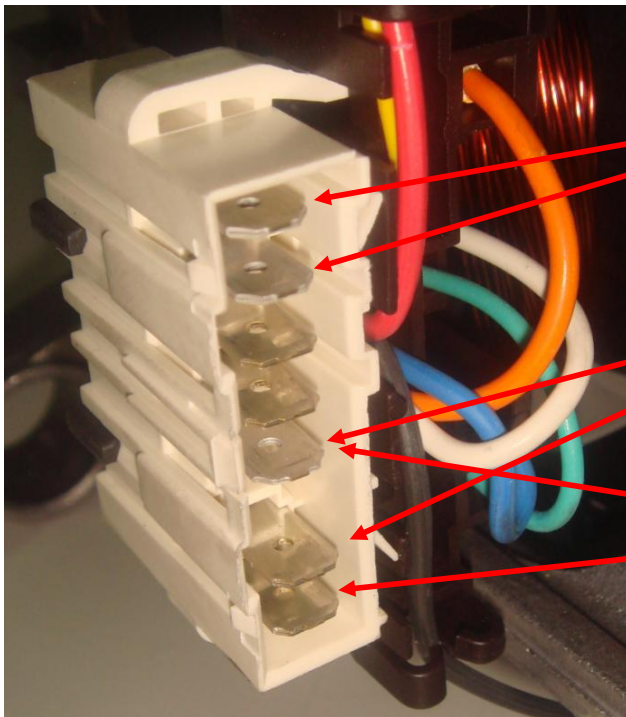
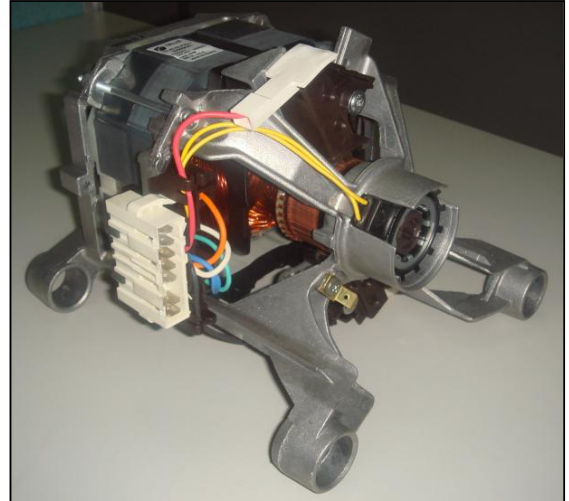

Tacho  
Socket  
Terminal

Stator Full Field  
Coil Socket  
Terminal

Stator Half Field  
Coil Socket  
Terminal

Motor Socket Terminals

Tacho and stator (full field-half field) ohm resistance values for the motor types are listed in the below table.

MOTOR KODU	FİRMA	STATOR (TAM SARGI) (ohm)	TAKO (ohm)	STATOR (YARIM SARGI) (ohm)	SICAKLIK
32003986	ACC	3.30-/+ 7%	184-/+7%	1.20-/+7%	20 °C
32004905	ACC	2.70-/+ 7%	184-/+7%	1.04-/+7%	20 °C
32006966	ACC	3.00-/+ 7%	184-/+7%	1.50-/+7%	20 °C
32007450	ACC	2.70-/+ 7%	184-/+7%	1.08-/+7%	20 °C
32004572	ACC	1.20-/+ 7%	184-/+7%	0.60-/+7%	20 °C
32008809	ACC	0.96-/+ 7%	184-/+7%	-	20 °C
30027193	ANAIMEP	1.87-/+7%	180-/+10%	-	20 °C
30023397	ANAIMEP	1.75-/+7%	180-/+10%	-	20 °C
32002064	ANAIMEP	2.01-/+7%	180-/+7%	-	20 °C
32003425	ANAIMEP	2.01-/+7%	180-/+7%	-	20 °C
32000536	ASKOLL (CESET)	1.01-/+7%	68.7-/+7%	-	20 °C
32000271	ASKOLL (CESET)	1.40-/+7%	68.7-/+7%	0.56-/+7%	20 °C
32000535	ASKOLL (CESET)	1.24-/+7%	68.7-/+7%	-	20 °C
30027193	ASKOLL (CESET)	2.26-/+7%	68.7-/+7%	-	20 °C
32008661	ASKOLL (CESET)	1.90-/+7%	68.7-/+7%	0.74-/+7%	20 °C
30023397	ASKOLL (CESET)	1.83-/+7%	68.7-/+7%	-	20 °C
32004970	ATB	1.62-/+ 7%	87-/+12%	-	20 °C
32004969	ATB	1.62-/+ 7%	87-/+12%	0.81-/+7%	20 °C
32009041	ATB	1.62-/+ 7%	87-/+12%	0.81-/+7%	20 °C
32004968	ATB	1.20-/+ 7%	87-/+12%	-	20 °C
32009040	ATB	1.20-/+ 7%	87-/+12%	-	20 °C
32008659	BROAD OCEAN	2.15-/+7%	66.7-/+7%	-	20 °C
32008660	BROAD OCEAN	2.15-/+7%	66.7-/+7%	-	20 °C
32005496	IDEA	4.60-/+7%	227-/+7%	-	20 °C
32007954	WELLING	2.08-/+7%	66.6-/+7%	-	20 °C
32007955	WELLING	1.59-/+7%	66.6-/+7%	-	20 °C
32008852	WELLING	2.00-/+7%	66.6-/+7%	-	20 °C
32008853	WELLING	2.15-/+7%	66.6-/+7%	-	20 °C

Resistance values for the motor types

### 8.6.1. Resistance Controlling By Connection Measurement (Tacho)

You can determine the ohm value by measuring from the yellow cable and yellow cable (refer wiring diagram at page 43) as shown in belows figures. For resistance values, refer to the table.

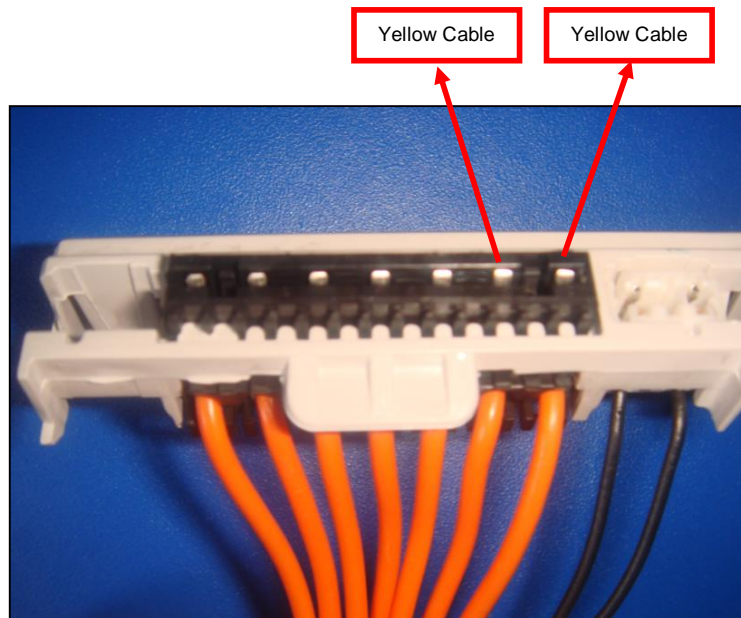

### 8.6.2. Resistance Controlling By Connection Measurement (Stator)

You can determine the ohm value by measuring from the yellow cable and yellow cable (refer wiring diagram at page 43) as shown in belows figures. For resistance values, refer to the table.

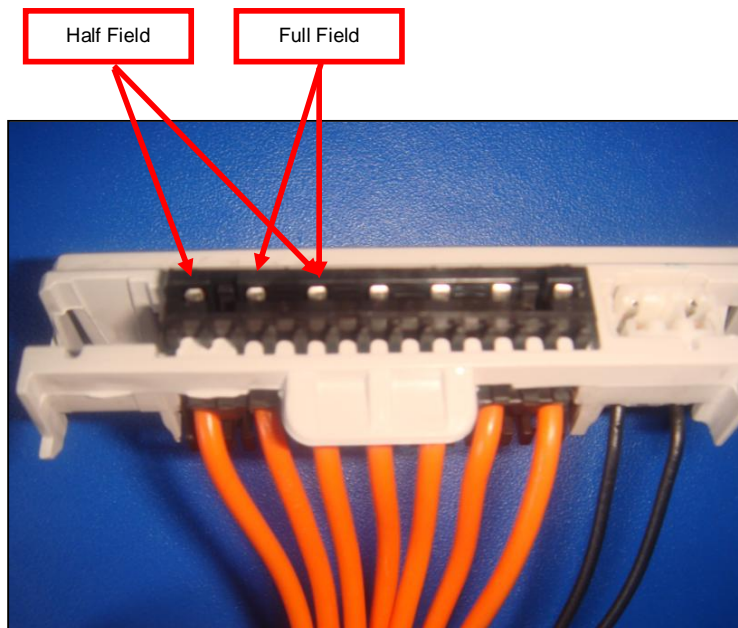

## 8.7. Door Lock

Door lock is activated at the beginning of the program in order to prevent the door from opening. It can be unlocked approximately after 2 minutes of the program end. This time delay is caused by the PTC which is assembled in the door lock.

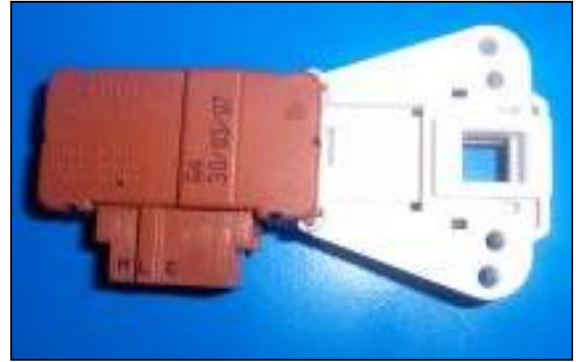

### 8.7.1. Technical Features

Lock Time (20 °C)	2" – 6"
Unlock Time (20 °C)	35" – 75"
Nominal voltage	220 V
Nominal current	16 (4) A

### 8.7.2. Checking of Component

Check the resistance value on the component with multi-meter as shown in below figures. Resistance value on the PTC should be  $1000 \Omega \pm 50\%$  at 25 °C. That resistance value can be measured from terminal 3-4 (See wiring diagram page 51 below).





### 8.7.3. Component Controlling By Connection Measurement

You can determine the ohm value of the door lock by measuring from the yellow cable and white cable (refer wiring diagram at page 43) as shown in belows figure.  
Each valve bobbin resistance values should be between 500 – 1500 ohm .

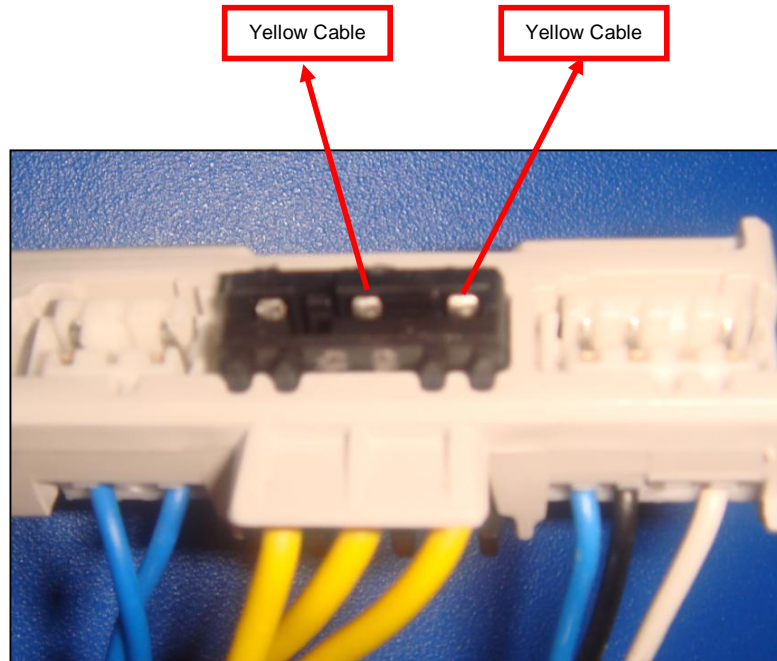

## 9. Wiring Diagram

### 9.1. Wiring Diagram

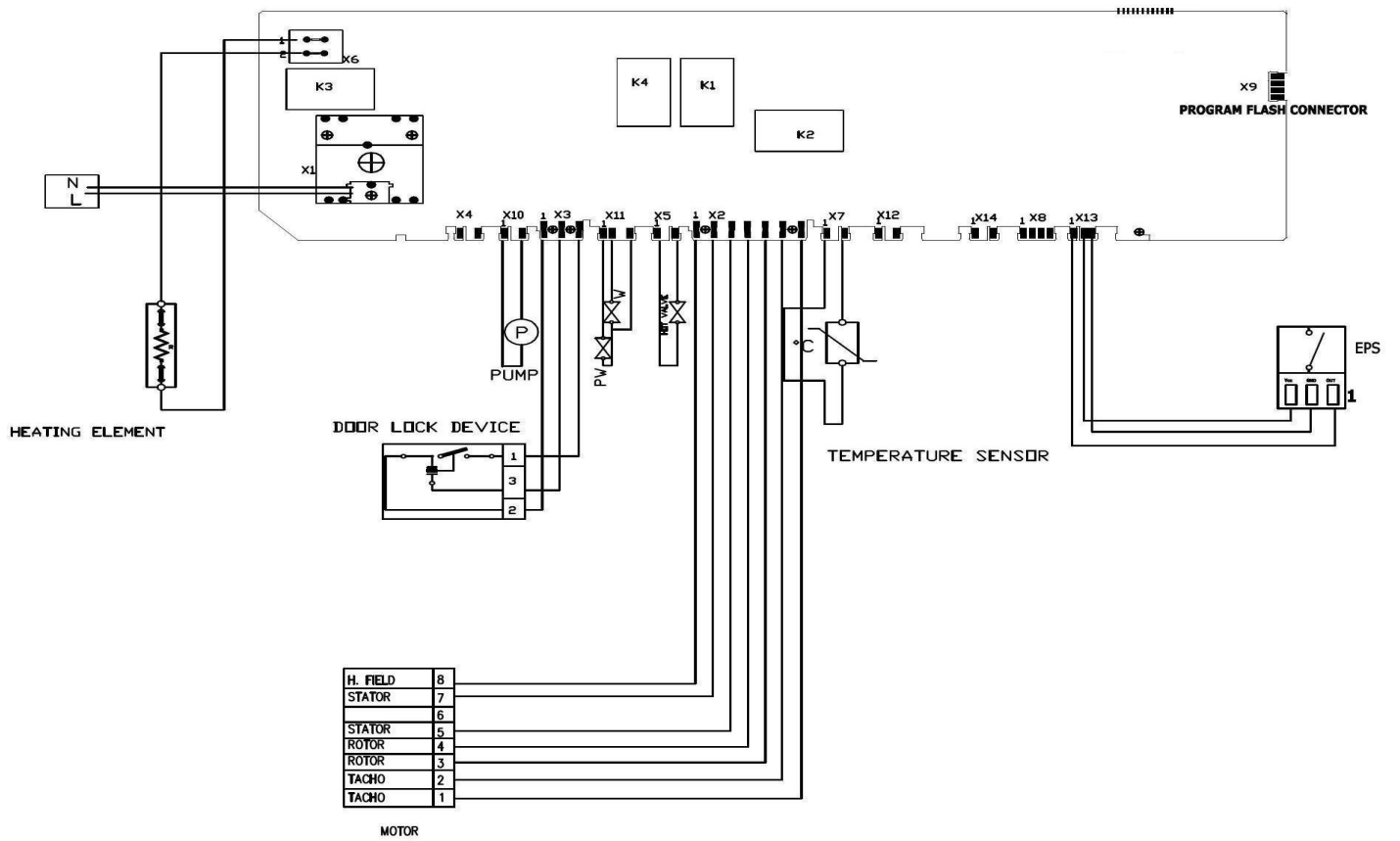

## 9.1. Wiring Diagram

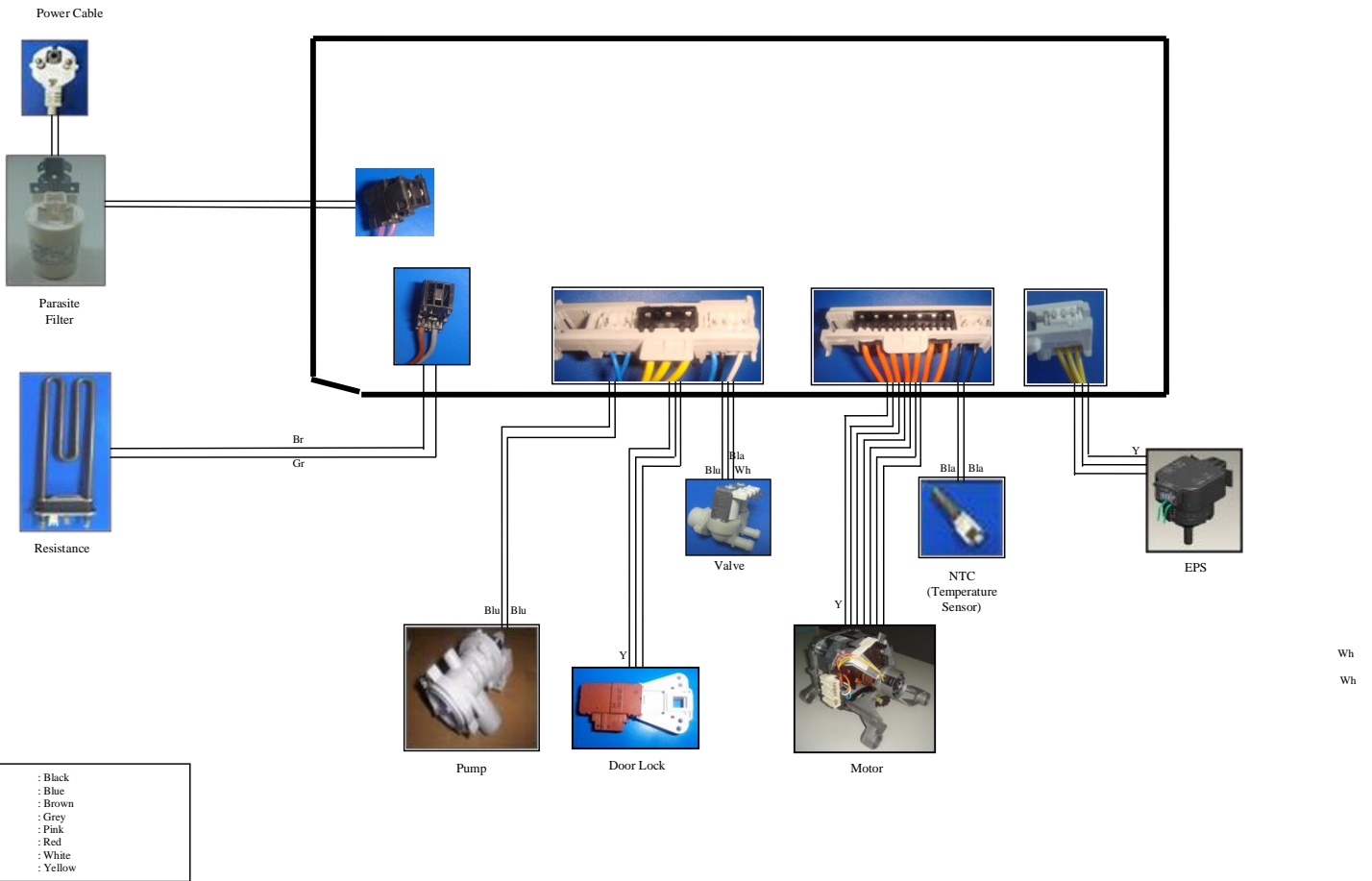

Wh  
Wh