

Instructions manual

# Eurosafe 60



**EURONDA®**



**Instructions manual  
Operating manual**

**WASHER DISINFECTOR**

**EUROSAFE 60**

**CE 0051**

**Distributor:**

**EURONDA S.p.A.**  
Via dell'Artigianato 7  
Montecchio Precalcino (VI) Italy  
tel. +39 0445 329811  
fax +39 0445 865246  
info@euronda.com  
www.euronda.com

**Manufacturer:**

**STEELCO S.p.A.**  
Via Balegante, 27  
31039 Riese Pio X (TV)  
ITALIA

# CONTENTS

<b>1. GENERAL RULES.....</b>	<b>6</b>
1.1 LIMITS OF MANUFACTURER'S LIABILITY.....	6
1.2 MANUAL VALIDITY, CONTENTS AND CONSERVATION .....	6
1.3 REGULATIONS.....	7
<b>2. SAFETY INFORMATION.....</b>	<b>8</b>
2.1 INTENDED USE, IMPROPER USE .....	8
2.2 IMPORTANT WARNINGS AND SUGGESTIONS.....	9
2.3 SAFETY RECOMMENDATIONS .....	9
2.4 RECOMMENDATIONS TO ENSURE HIGH QUALITY PERFORMANCE.....	10
2.4.1 INLET WATER QUALITY.....	11
2.5 RESIDUAL RISKS.....	12
2.6 SAFETY SIGNAL USED.....	13
2.7 TRAINING.....	14
2.7.1 STAFF QUALIFICATION .....	14
2.8 INDICATION OF SOUND LEVEL .....	15
2.9 TRANSPORT AND STORAGE.....	15
<b>3. INSTALLATION (FOR THE INSTALLER ONLY).....</b>	<b>16</b>
3.1 ACTIVITY PRIOR TO INSTALLATION.....	16
3.2 POSITIONING.....	16
3.2.1 MOVEMENT, UNPACKING AND PLACING .....	16
3.2.2 MAXIMUM FLOOR LOAD .....	17
3.2.3 POSITIONING OF THE MACHINE .....	17
3.3 WATER CONNECTION (FOR THE INSTALLER ONLY) .....	18
3.4 ELECTRICAL CONNECTION .....	19
3.5 FUSE .....	20
3.5.1 REPLACEMENT OF FUSE .....	20
3.6 CHEMICAL PRODUCTS CONNECTIONS.....	21
3.6.1 PRESENCE SENSOR OF CHEMICAL PRODUCT .....	21
3.6.2 METER QUANTITY OF CHEMICAL PRODUCT .....	21
3.6.3 REPLACEMENT OR REFILL OF CHEMICAL PRODUCT .....	21
3.6.4 WARNING.....	22
3.6.5 INFORMATION.....	22
3.7 CONNECTING THE DISCHARGE PIPE .....	22
3.8 WATER SOFTENER .....	23
3.9 DRYING AIR FILTRATION (OPTIONAL).....	24
3.10 AMBIENT VENTILATION REQUIREMENTS.....	24
<b>4. CHECKS PRIOR TO START-UP.....</b>	<b>25</b>
4.1 INTRODUCTION.....	25
4.2 CHECKS OF SAFETY SYSTEMS .....	25
4.3 GENERAL CONTROLS .....	25
<b>5. USING THE MACHINE (FOR THE USER).....</b>	<b>26</b>
5.1 CHECKS.....	26
5.2 OPENING AND CLOSING THE DOOR.....	26
5.2.1 DOOR UNLOCKING .....	26
5.3 SWITCHING ON.....	27
5.4 PREPARATION.....	27
<b>6. CONTROL PANEL AND SYMBOLS USED.....</b>	<b>29</b>
6.1 CONTROL PANEL (LOADING SIDE) .....	29
6.1.1 KEYS .....	31
<b>7. WASHING PROGRAMMES.....</b>	<b>33</b>
7.1 PRE-PROGRAMMED CYCLES.....	33
7.2 PHASE PARAMETERS .....	34
7.2.1 DRAIN PHASE.....	34
7.2.2 PREWASHING PHASE .....	34
7.2.3 TREATMENT PHASE.....	34

7.2.4	DRYING PHASE.....	34
<b>8.</b>	<b>MACHINE STATUS .....</b>	<b>35</b>
8.1	WAIT .....	35
8.2	CYCLE .....	35
8.3	SHUTDOWN .....	35
<b>9.</b>	<b>SPECIAL FEATURES.....</b>	<b>35</b>
9.1	POWER FAILURE.....	35
9.2	RESET PROCEDURE .....	35
<b>10.</b>	<b>WORK PROCEDURES .....</b>	<b>36</b>
10.1	INTRODUCTION.....	36
10.2	INSTRUCTIONS TO PERSONNEL.....	36
10.3	DECONTAMINATION PROCEDURES .....	36
<b>11.</b>	<b>MENU .....</b>	<b>37</b>
11.1	MENU PLAN .....	37
11.2	PARAMETERS SETTINGS .....	41
11.3	PARAMETER LIST .....	41
11.4	DETAILS OF THE ELECTRONIC CARD .....	45
11.5	FEATURES OF MASTER CARD .....	45
11.6	STARTING UP AND DISPLAY OF DEVICES.....	46
11.7	PASSWORD MANAGEMENT.....	47
11.7.1	PASSWORD CHANGE.....	47
11.7.2	WARNING ABOUT UNAUTHORIZED ACCESS.....	47
<b>12.</b>	<b>CHEMICALS CALIBRATION .....</b>	<b>48</b>
12.1	TIMED DOSING.....	48
12.1.1	CALIBRATION .....	48
12.1.2	CHECK .....	49
12.2	IMPULSED DOSING .....	50
12.2.1	CALIBRATION .....	50
12.2.2	CHECK .....	51
<b>13.</b>	<b>CLOCK .....</b>	<b>52</b>
<b>14.</b>	<b>HISTORICAL DATA .....</b>	<b>52</b>
<b>15.</b>	<b>ALARMS AND EVENTS LIST .....</b>	<b>53</b>
15.1	LOGICAL DESCRIPTION OF ALARM INTERVENTIONS .....	53
15.2	LIST OF ALARM MESSAGES.....	53
<b>16.</b>	<b>PC INTERFACE.....</b>	<b>55</b>
<b>17.</b>	<b>USB PORT .....</b>	<b>56</b>
17.1.1	PROGRAMMING .....	56
17.1.2	DATA SAVING .....	56
17.1.3	DATA SAVING DURING THE CYCLE .....	57
17.1.4	OPERATOR ARCHIVE MANAGEMENT .....	58
<b>18.</b>	<b>MAINTENANCE.....</b>	<b>59</b>
18.1	GENERAL RECOMMENDATIONS ON MAINTENANCE .....	59
18.1.1	MAINTENANCE REQUEST .....	59
18.2	PROCEDURE FOR ROUTINE MAINTENANCE WORK.....	59
18.3	TABLE OF ROUTINE MAINTENANCE TASKS .....	59
18.4	PROCEDURE FOR SPECIAL MAINTENANCE WORK.....	65
18.5	TABLE OF SPECIAL MAINTENANCE TASKS .....	65
<b>19.</b>	<b>PROBLEMS – CAUSES – SOLUTIONS.....</b>	<b>70</b>
19.1	INTRODUCTION.....	70
19.2	PROBLEMS - CAUSES - SOLUTIONS .....	70
<b>20.</b>	<b>DECOMMISSIONING.....</b>	<b>72</b>
20.1	INSTRUCTIONS FOR DISASSEMBLY OF THE MACHINE .....	72
20.2	MACHINE DISPOSAL .....	72

Thank you for purchasing this appliance.

The installation, maintenance and operating instructions given in the following pages have been prepared to ensure the long life and good performance of the appliance.

Following the instructions carefully.

The appliance was designed and constructed using the latest technological innovations available.  
Please take good care of it.

Your satisfaction is our best reward.

**WARNING**

**NON OBSERVANCE, EVEN IN PART, OF THE RULES INDICATED IN THIS MANUAL WILL CAUSE THE PRODUCT GUARANTEE TO BECOME INVALID AND RELIEVES THE MANUFACTURER OF ANY RESPONSIBILITY.**

# 1. GENERAL RULES

## 1.1 Limits of manufacturer's liability

The manufacturer shall not be held liable for failures or problems which arise due to tampering and/or incorrect applications and/or improper use of the machine.

The purchaser must comply with all instructions set forth in the user's manual, and he must in particular:

- Always work within the allowable limits for the use of the machine;
- Always carry out constant and diligent maintenance;
- Allow use of the machine by persons with proper skills and abilities for their role and purpose who have been properly trained and instructed;
- Use only manufacturer original spare parts.

Any modifications, adaptation or the like which may be made to machines which are subsequently placed on the market do not oblige the manufacturer to intervene on previously supplied machines, nor to consider the machine and the related user's manual lacking and inadequate.

The installation, maintenance and operating instructions given in the following pages have been prepared to ensure the long life and outstanding performance of the appliance.

For some especially demanding programming or maintenance operations, this manual serves as a memorandum of the main operations to be carried out.

Education on these topics can be obtained by attending training course held by the manufacturer.

The instructions in this manual do not replace but rather are in addition to employer requirements to adhere to current legislation on standards of prevention and safety.

The machine is guaranteed for 15 months as from the time of shipment.

## 1.2 Manual validity, contents and conservation

- This manual reflects the state of the art at the moment of manufacture and delivery of the appliance and is valid for its entire life cycle.
- The manufacturer is at clients' disposal for further information or to receive suggestions for making the manual more compliant with the needs for which it was prepared.
- The translation of the contents into the client's language has been carefully prepared.
- In order to prevent possible accidents to persons or property due to incorrect translation of the instructions, the client must:
  - Not perform operations or manoeuvres with the machine if there are any doubts or uncertainties about the operation to be performed;
  - Ask technical service for clarification of the instruction.
- If lost, ask for a new copy from the manufacturer.

It is important to keep this instruction manual with the machine for future reference.

If the machine is sold or transferred, the manual must be handed over to the new owners or user in order for them to become acquainted with its functioning and the relative warnings.

**Read the warnings carefully before installing and using the machine.**

**This is a translation of the Italian text, which prevails in case of doubts.**

## 1.3 Regulations

The purpose of the warnings is to safeguard the user in compliance with following Regulations and "Technical Product Standards":

### EUROPE:

- 93/42/EEC and s.m.i. (Medical Devices Directive);
- 2006/95/EC (Low Voltage Directive);
- 2014/30/EU (EMC - Electromagnetic compatibility directive);
- EN 61010-1 (Safety);
- EN 61010-2-040 (Safety);

### and recognized international standards:

- IEC 61000 (Electromagnetic compatibility);
- ISO 14971 (Medical devices risk analysis);
- IEC 61326-1 (Electromagnetic compatibility);
- ISO 15883-1 (Cleaning efficacy);
- ISO 15883-2 (Cleaning efficacy);
- ISO/TS 15883-5 (Cleaning efficacy);
- IEC 60529 (IP Grade).



## 2. SAFETY INFORMATION



Compliance with safety standards allow the operator to work productively and calmly, without the danger of harming himself or others.

Before starting work, the worker must be completely familiar with the functions and proper operation of the machine. He must know the precise function of all command and control devices of the machine.

### 2.1 Intended use, improper use

#### INTENDED USE:

Use is permitted of this machine only and exclusively for washing and thermal disinfection of orthodontic instruments, trays and objects normally used in orthodontic studios, hospital wards, assisted living centres, and so forth, like:

- Scissors
- Clogs
- Glass works
- Laboratory instruments

#### IMPROPER USE:

The improper use of this device is any use other than that for which the machine is intended.

	<b>WARNING</b>
	<b>Any use other than the one intended is forbidden.</b>
	Improper use of this unit may be hazardous to the operator and may seriously damage the machine itself.
	If the appliance is used in a manner not specified by the manufacturer, protection of the appliance may be compromised.

**Advisory note:** under ISO 17664:2004, it is the instrument manufacturer's responsibility to provide instructions for the processing of their instruments including how instruments should be prepared prior to use, cleaned, disinfected, dried, inspected, maintained, tested packaged, sterilized and stored. If medical devices have been used in any way such as being exposed to blood or compromised tissues, such devices must be terminally processed in accordance with the instrument manufacturer's guidelines, observing international and local standards as well as good hospital practices before each use with human patients. Washer disinfectors are part of the process for reprocessing reusable medical devices.

This washer disinfectant device is not intended to be used for terminal disinfection or sterilization.

## 2.2 Important warnings and suggestions

For proper use of the machine, and in order to safeguard employed staff, carefully comply with the following general and specific standards.

### THE OPERATOR MUST:

- **Carefully adhere to the provisions and instructions** provided by the employer, managers and supervisors for individual and group safety.
- **Use safety devices appropriately and with care**, as well as group and individual safety gear provided by the employer.
- **Immediately inform the employer**, the manager and the supervisor of deficiencies in the aforementioned devices and means, as well as any hazardous conditions which he may become aware of, taking action directly in urgent cases within their scope of responsibilities and abilities to eliminate or reduce the deficiencies or hazards.

### THE OPERATOR MUST NEVER:

- **Remove or modify, without authorization, the safety devices**, nor those for signalling and measuring, nor the individual and group safety gear.
- **Undertake on his own initiative operations or manoeuvres which are not his responsibility** which may compromise safety.
- **Insert foreign objects into the electrical parts.**  
Do not insert foreign bodies into the covers of the electrical motors or into the moving parts of the machine.
- **Provide power to the machine by tampering with the main switch and the safety devices.**

## 2.3 Safety recommendations

- If the new machine appears to be damaged, contact the retailer before starting it.
- Any modification of electrical and hydraulic systems necessary to install the machine must be carried out by qualified, authorised persons only.
- This machine must be operated by trained persons only;
- The machine must be used for treatment and thermo disinfection of instruments for orthodontic and medical use and for laboratory glasses.
- Any use other than that for which the machine was intended is forbidden.
- The user is forbidden to carry out any work or repairs on the machine
- Technical Assistance for this washer disinfector should be carried out by qualified and authorised operators only.
- The equipment should be installed by authorised persons only.
- Do not install the equipment in rooms where there is the risk of explosion.
- Do not expose the equipment to intense cold.
- The electrical safety of this washer disinfector is only guaranteed if it is connected to an efficient earth system.
- Take great care when handling detergents and additives: avoid contact, wear gloves and act in compliance with the safety recommendations indicated by the manufacturer of the chemical products.
- Do not inhale the fumes produced by chemical products.

### WARNING:

**The chemical products are an irritant for the eyes, in case of contact rinse thoroughly with plenty of water and consult a doctor.**

**If these products come into contact with the skin, rinse with plenty of water.**

- The water in the tank is not drinking water.
- Do not lean on the door and do not use it as a step.
- The machine reaches a temperature of 93°C during the work cycle: take great care to avoid burns.
- Do not wash the machine using high-pressure jets of water.
- Disconnect the machine from the electrical supply before carrying out maintenance work.
- The acoustic pressure of the machine is below 70 dB(A).
- The operator always has to verify before starting of the cycle the presence of the filters water in the sump and their correct positioning.



## 2.4 Recommendations to ensure high quality performance

- The user must oversee the machine during the cycle.
- The injection tube for washing water must always be connected with the appropriated basket.
- When the machine is running do not interrupt the cycle since this jeopardises disinfection.
- Check periodically using chemical indicators to ensure correct disinfection.
- Use recommended detergents and chemical additives only.  
The use of other products may damage the machine.
- During the manipulation of treated objects, it is required the use of appropriated PPE to prevent contact with infected material and the risk of contamination.
- Do not introduce dirty instruments of substances that must not be discharged in sewage system (in accordance with current legislation) but must be disposed in specific way.
- Recommending chemical additives does not make the manufacturer responsible for any damage to the materials and objects treated.
- Check that type of chemical product is suitable for the specific washing program used.
- Follow the manufacturer's indications when using chemical products and use them for the foreseen use only.
- The machine was designed for use with water and chemical additives.  
Do not use organic or other types of solvent as this may result in the risk of explosion or the rapid deterioration of certain machine parts.
- Residues of solvents or acids, particularly "hydrochloric acid", can damage steel.  
Contact should be avoided.
- Use original accessories only.
- Do never use soap powder.
- Do never use foaming detergent.
- The machine is to be used only with the baskets and or accessories included by the manufacturer.
- Accessories which are not approved by the manufacturer may compromise the results achieved as well as user safety.
- Do never use chemical products based on chlorides (bleaches, sodium hypochlorite, hydrochloric acid and so on).
- These kinds of chemical detergents irreparably damage the machine and jeopardise the integrity of materials and objects treated.

The taps of the water feeding must be always turned off, as the safety and diagnosis system will be deactivated, in the following situations:

- if the machine is left unused;
- if the machine is disconnected from the electrical connection.

**The manufacturer declines all responsibility for personal injury or material damage resulting from the non-observance of the above rules.**

**The non-observance of these rules produces the total and prompt cancellation of the guarantee.**

## 2.4.1 Inlet water quality

The quality of the water used in all stages of cleaning is important for good results.

The water used in each stage must be compatible with:

- The material of which the washer disinfectant is made.
- The chemicals used in the process.
- Process requirements for the various stages of the process.

The main factors for good inlet water quality in relation to the washing efficacy are:

<b>HARDNESS</b>	The high hardness of the water generates a detergent inactivation, reducing its efficacy. It also causes limescale deposits in the machine, jeopardizing the clean of the instruments and the machine, especially on hot parts (ex. heating elements).
<b>IONIC CONTAMINANTS</b>	A high concentration of ionic contaminants may cause corrosion of steel, manganese or copper instruments.
<b>MICROBIAL CONTAMINANTS</b>	Microbial contaminants can increase the microbial contamination of the instruments at the end of the wash.

The manufacturer therefore recommends that:

- water used in the pre-rinsing and washing phases should be of drinkable quality in accordance with the "Guidelines for drinking water quality 3<sup>rd</sup> edition" published by WHO.
- demi water is used for the rinsing phase.

A typical specification for demi water is:

<b>Ion concentration H+</b>	4.5...7 pH
<b>Conductivity</b>	< 30 $\mu\text{s}\cdot\text{cm}^{-1}$
<b>TDS</b>	< 40 mg/l
<b>Maximum hardness (CaCO<sub>3</sub>)</b>	< 10 mg/l
<b>Chlorine</b>	< 10 mg/l
<b>Heavy metals</b>	< 10 mg/l
<b>Phosphates</b>	< 0.2 mg/l as P <sub>2</sub> O <sub>5</sub>
<b>Silicates</b>	< 0.2 mg/l as SiO <sub>2</sub>
<b>Endotoxins</b>	< 0.25 EU/ml
<b>Colony-forming unit (CFU)</b>	< 100 per 100 ml (*)

(\*) for rinsing after disinfection phase, the maximum limit changes to 0.

Further advice should also be obtained from the manufacturers of chemical and medical equipment. Where local standards are stricter than provided recommendations, they should be followed.

**Note: that it is the user's responsibility to supply the machine with suitable water.**

## 2.5 Residual risks

The appliance includes a series of fixed guards to prevent access to hazardous internal parts or zones.

It is however considered that the **WASHER DISINFECTOR** includes some residual risks. Hereunder for each phase or significant work intervention are useful measures to be taken:

PHASE	BASKET LOADING
RISK	<b>Contusions and cuts to the upper limbs</b> , due to accidental contact with due to falling or striking against tools, objects and instruments, mainly while loading and handling the basket.
MEASURE	Assign staff that is instructed and equipped with work equipment (e.g. basket with protections, transport carts) and appropriate clothing and individual protection gear (e.g. shirts and protective gloves).

PHASE	OBTAINING DETERGENTS/CHEMICAL ADDITIVES
RISK	<b>Contact with body parts with chemical washing products.</b>
MEASURE	Assign staff that is instructed and equipped with appropriate clothing and individual protection gear. Wear clothing, gloves and goggles and act in compliance with the safety recommendations indicated by the manufacturer of the chemical products.
FIRST AID MEASURE	<ul style="list-style-type: none"> <li>Immediately take off/remove clothing which has been contaminated or soaked by the product.</li> <li>If the substances come into contact with the skin, wash off affected skin areas immediately and rinse with water.</li> </ul>
RISK	<b>Inhalation of vapours of chemical wash products.</b>
MEASURE	Assign staff that is instructed and equipped with appropriate clothing and individual protection gear. Comply with the safety instructions provided by the manufacturer of the chemical products and if there are none, wear a mask for the protection of the respiratory airways.
RISK	<b>Accidental release of chemical wash product.</b>
MEASURE	Do not flush concentrate into drains, surface or ground waters. Collect spillage with adsorbent material (e.g. sand, earth, vermiculite, diatomaceous earth). Flush away minor amounts with plenty of water.
	<b>IN CASE OF CONTACT WITH BODY OR RELEASE OF CHEMICAL PRODUCT LOOK ALWAYS AT THE SAFETY MEASURES INDICATED IN THE CHEMICAL TECHNICAL DATASHEET.</b>

PHASE	MAINTENANCE OF INTERNAL EQUIPMENT
RISK	<b>Burns of body parts by hot parts of the appliance.</b>
MEASURE	Allow maintenance to be performed only by trained personnel, equipped with appropriate clothing and individual protection gear. Wear suitable clothing and protective gloves.

PHASE	EMISSION OF HAZARDOUS GAS
RISK	<b>Inhalation of vapours of hazardous gas.</b>
MEASURE	With a correct installation, concurring with the manufacturer prescription, using the authorized chemical product and concurring with the rules in force in your country, the machine don't generate hazardous gas. However the machine is supplied with vapours discharge, that have to be connected concurring with the instruction in chapter 3.

## 2.6 Safety signal used

To inform personnel operating on the machines of obligations of behaviour and residual risks, adequate safety signals (as set forth by 92/58 EEC) are applied to the machine and near the work place.

### **GENERIC SAFETY SIGNALS:**

In particular, labels with signals of obligation, prohibition and danger contained in this manual and pertinent to this machine and most commonly used are:



**Electrical risk**



**Warning!**  
**See annex documentation**



**CAUTION**  
**HOT SURFACE**  
**Caution hot surface**

### **INDIVIDUAL SAFETY WEAR:**

The evaluation of risks for the health and safety of workers carried out in the workplace and on any equipment used, as well as the evaluation of residual risks as indicated, allow the employer to evaluate the need to adopt the individual protection gear which is most suitable and appropriate to be provided to workers.

Considering the type of machine, it is felt that the individual protection gear should be provided to staff.

## 2.7 Training

Instructions for use of the machine will be provided by the INSTALLATION TECHNICIAN during the start-up phase to MACHINE OPERATORS and MAINTENANCE TECHNICIANS for their areas of responsibility, who will be thus instructed and trained.

It will be the duty of the EMPLOYER to check that the degree of staff training is suitable for assigned duties.

### 2.7.1 Staff qualification

Depending on the difficulty of certain installation operations, and of the operation and maintenance of the system, professional profiles are identified as follows:

#### **IS** *INSTALLATION and REPAIR TECHNICIAN:*

Specialized installation and maintenance staff capable of carrying out all machine positioning and installation operations, connection of various systems and machine start-up at the client's place of business, as well as all routine and special maintenance operations.

This operator is responsible for training staff for machine operation and for testing the machine.

#### **AS** *RESPONSIBLE AUTHORITY FOR THE MACHINE IN THE WORKPLACE:*

Specialized staff assigned to the verification of safety devices and procedures for proper use of the machine in complete absence or hazards.

The *responsible authority* is personally responsible for training courses for staff assigned to machine operation and maintenance.

He must ensure that staff assigned to operation have acquired all information required for use and routine maintenance of the machine, registering attendance and documenting comprehension tests.

The *responsible authority* must have a perfect understanding of all command, control and safety devices of the machine.

He must inform all personnel assigned to machine operation and maintenance of the instructions concerning *safety standards*, the *actions to be avoided* and the *first aid interventions* connected with use of the machine and the chemical wash agents it contains.

The *responsible authority* must be aware of all correct procedures for carrying out in absolute absence of danger all operation and maintenance of the machine, as well as all procedures for disposal of any residual pollutants and manufacturing wastes.

He must always be present during extraordinary or routine maintenance and give his *approval to proceed* to staff assigned to operation or to personnel assigned to routine or special maintenance.

The *responsible authority* will be responsible for operation of all command, control and safety devices in the machines of the system.

He shall carry out scheduled verification of those devices in order to ensure their continued operation over time.

#### **AC** *MACHINE OPERATOR:*

Skilled personnel assigned to machine operation.

The *machine operator* must be perfectly aware of all of the machine's command and control devices.

Only after approval by the *safety supervisor*, the *machine operator* must be capable of using the assigned commands to do the following:

- Commissioning and start-up of the machine;
- Loading and unloading of material to be washed in the baskets;
- Operation of the machine in the various possible working modes, such as the start of various programmed wash cycles.
- Programming and setting data from the operator panel, adjustment of single control devices during working phases, starting or resetting of work functions.
- In addition, the *machine operator* must, by making use of all required individual protection gear and following adequate safety measures, be capable of performing some routine maintenance such as cleaning inside the machine, cleaning clogged filters, and disposing of pollutant waste materials produced during working.

## 2.8 Indication of sound level

The value shown refers to the measurement obtained on a machine of the same type as that covered herein and measured with an instrument at a height of 1.5 m at a distance of 1 m from the machine.

**AVERAGE SOUND PRESSURE LEVEL:** < 70 dB (A)

## 2.9 Transport and storage

### Environment conditions:

- Temperature range -5 ... +50 °C;
- Relative Humidity range 20...90% without condensation;
- Ventilation: Air exchange not required (required only if chemical tanks are installed).



## 3. INSTALLATION (FOR THE INSTALLER ONLY)

### 3.1 Activity prior to installation

#### **PREPARATION OF INSTALLATION SITE:**

Arrangements for connections to the electrical and plumbing systems must be provided by the client prior to machine installation.

Connections must be compliant with current directives in the country of installation and they must comply with the instructions contained in the documentation (provided on request) prior to machine installation.

#### **Environment conditions:**

- Temperature range +5...+40°C;
- Relative Humidity range 20...90% without condensation.
- Maximum altitude: 2.000 m SLM (for higher altitudes are available special versions of the device).

### 3.2 Positioning

#### 3.2.1 Movement, unpacking and placing

The machine is delivered to the client fully packed, resting on a wood base and completely protected by cardboard covering.

#### **LIFTING AND MOVEMENT:**

Movement of the machine is provided using transport and lifting equipment and must be observed the following indications:

- The lifting capability of the forklift must be greater than the total weight of the machine to be moved.
- The machine must be kept as close as possible to the ground during movement;
- Stack up: not allowed;
- Rotation: do not turn upside down.

**The forklift operator must perform movement only when there are no persons or objects in the movement area.**

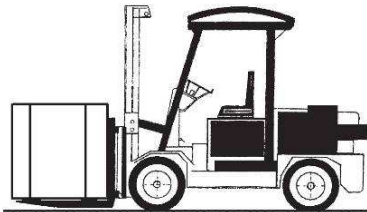

#### **UNPACKING AND PLACING:**

Near the place of installation, unpack the machine.

Carefully follow these steps:

All the packaging materials can be recycled.

- Open the packaging carefully.
- Do not overturn the machine as this may cause irreparable damage.
- Cut the strap or open the box and remove the expanded polystyrene corner guards.
- Remove the box followed by the nylon bag.

**Caution: the bag represents a serious hazard for children and should be disposed of immediately.**

- Place the machine on the work surface and level it by adjusting the feet.
- The machine must be placed horizontally with a maximum inclination of 1÷2°.
- Do not position the machine on surface which could cause a fire or fume hazard.

### 3.2.2 Maximum floor load

For the installation of the machine, the floor must be able to sustain a minimum load of:

**175 daN/m<sup>2</sup>**

### 3.2.3 Positioning of the machine

In normal conditions, the minimum dimensions are suggested for the use of the machine in a single installation or with the coil nearby.

For different installation ask for the distributors.

**Minimum room ceiling height: HEIGHT MACHINE (in m) + 0,3 m**

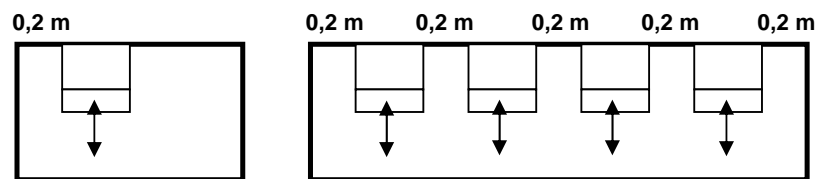

### 3.3 Water connection (for the installer only)

To perform proper installation, account of following regulations:

- The machine has been connected to the water distribution network following the in force rules;
- Use only the tubes supplied with the machine;
- Don't cut short the rubber tubes supplied with the machine;
- Make sure that mains water pressure is between 100 kPa and 800 kPa;  
If it is below 100 kPa (1 bar) dynamic pressure, you will need to install a pressure increase pump.  
If the pressure is higher than 800 kPa (8 bar) a pressure reducer must be installed.
- For machines equipped with steam condenser or water softener, the minimum pressure of water must be increased to 200 kPa (2 bar g) to ensure the correct functioning in terms of performance.
- If the average hardness of the water is higher than 7 °f, decalcified water must be used;
- For connection use cocks with an attachment of 3/4", located in an easily accessible location as near as possible to the machine;
- Make sure that the general feeding tube is sufficient for the flow rate required from the machine and equipped with a general closing valve.

	<b>ATTENTION</b>
	For the specifications for water connections, refer to the plant installation.

During the machine installation, the installer must take the following step:

1. Identify the tubes supplied with the machine and make sure they are free from damages;
2. Identify the correspondence of the connection of flexible tubes to the water supply taps arranged in site, according to the references of the following chart.

CONNECTION	COLOUR
HOT WATER	RED
COLD WATER	BLUE
DEMI WATER	WHITE

3. Screw and tighten up the pipe sleeve to the connection arranged in site.
4. Remove any debris in the pipes or in the taps. To perform this operation open the tap and let the water flow in a pail.
5. Check the water temperature according to the specifications of the installation diagram.
6. Identify the correspondence of the connection of flexible tubes to the solenoid valve water supply of the machine.
7. Screw and tighten up the pipe sleeve to the connection arranged in site.
8. Open gradually the water supply taps and check the connections seal.
9. Terminated the connection, in case of water leaks repeat the procedure.

	<b>ATTENTION</b>
	The threaded connections can be easily damaged, therefore before to apply the maximum clamping, screw manually the locking sleeve for some threads.

Information:

- The back syphonage prevention system is already installed inside the machine concurring with IEC61770;
- If it isn't available the double connection to hot and cold water, the two supply pipes must be connected together;
- **The manufacturer declines all responsibility for damage or injury caused by noncompliance of the rules relating the supply installations.**
- **If you don't comply with the conditions above, the deriving damages will not warranty.**
- **In case of lack of demineralized water set the parameter 3.37 to 1.**

	<b>ATTENTION</b>
	When the machine is not in operation, always close the supply cocks.

### 3.4 Electrical connection

**Connection of the machine to the electrical mains must be made by qualified, skilled personnel.**

Power supply cable: It is compulsory for the retailer - installer to adapt the insulation class of the power supply cable to suit the working environment in compliance with Current Technical Regulations.

- Check that the electric specifications match those shown in the label.
- The electrical connection must be carried out in compliance with current technical regulations.
- Make sure that the mains voltage reading corresponds to the voltage indicated on the machine plate.
- Check that the power supply voltage does not differ by more than 10% from its nominal value.
- The frequency of the power supply voltage must not differ by more than 1% of its value.
- Connection of the machine to the mains must be provided with an earth connection and an equipotential circuit as set forth by current standards.
  - Make sure that the electrical systems are efficiently earthed.

- The earth conductor is to be connected to the earth terminal identified by the standard symbol.



- The machine is equipped with a terminal identified by the relative symbol for equipotential connections between appliances (see rules for electrical plants).



- Connect the machine and the relative dedicated safety device (not supplied) by using a power cable compatible with the electrical characteristics of the machine.
- In case of prolonged unused of the machine is recommended that you execute the disconnection procedure of the electrical connection by placing the dedicated safety device in "OFF" state.
- The upstream electrical power line must be dimensioned and protected in accordance with current local regulations.

**The dedicated safety device must be positioned in an accessible place, free and not covered from other machine or anything that could obstruct the switch control.**

- The dedicated safety device must be provided with quality markings and must be indicated as an electrical shut-off device for the machine.
- Near the dedicated safety device, a sign must be placed which reads:

#### EXAMPLE OF DEDICATED SAFETY DEVICE POSITIONING

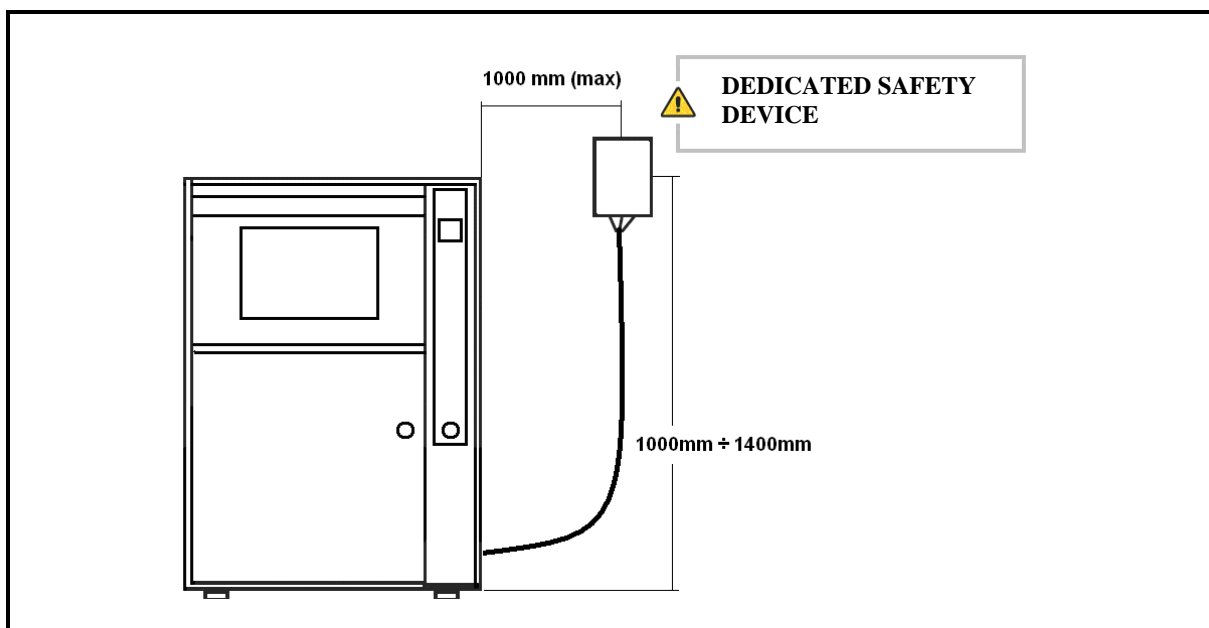

## 3.5 Fuse

The fuses are used to protect the electrical circuits of machine from possible failure as overload or short circuits. If fuse takes action the downstream connections and their function are no longer available.

**The fuses must respect the characteristics (size, dimensions and tripping characteristic) indicated in the wiring diagram.**

### 3.5.1 Replacement of fuse

	<b>ATTENTION</b>
	<p><b>The replacement of fuse must be done from authorized operators only.</b>  <b>Before making the replacement procedure of fuse, establish and remove the cause of the fault.</b>  <b>If necessary, contact our technical assistance service.</b></p>

#### Replacement procedure of fuse:

- Log off the machine in safety condition by dedicated safety device.
- Access at the electrical panel.
- Identify the fuse subjects to replacement, based on the wiring diagram.
- Remove the related fuse from electrical panel.
- Replace failure fuse with another fuse with same characteristics. The correct value of fuses are in the wiring diagram.

If at the reactivation of electrical devices the new fuse intervene repeat the diagnosis and replacement procedure as described previously.

	<b>ATTENTION</b>
	<p><b>Use only fuses with the amperage and characteristics indicated in the wiring diagram.</b>  <b>The use of fuses other than those specified in the wiring diagram, void the warranty and can cause the risk of damage the machine.</b></p>

### 3.6 Chemical products connections

The dosing system of chemical products is composed of:

- Dosing pump for chemical products.
- Presence sensor chemical product.
- The system can be equipped with meter quantity of dispensed product.

Further dosing pumps and accessories can be ordered as optional.

Each pump is combined with a corresponding type of chemical, according with the references on the table below.

PRODUCT	NOTE
DETERGENT	
ACID / RINSE AID (OPT)	

	<b>ATTENTION</b>
	<p>In order to guarantee the right treatment of the objects, we suggest the use of specific products. In the case of necessity, ask for advises to the seller or the producer.</p>

#### 3.6.1 Presence sensor of chemical product

Each dosing pump is combined with a sensor that confirm the presence of chemical product inside the container. If the product is scarce, the electronic control system of the machine send a message on video of lack of product.

#### 3.6.2 Meter quantity of chemical product

Each dosing pump can be combined with a volumetric sensor for the quantity measurement of dispensed product. The electronic control system manages the value of required minimum quantity and, if necessary, stops the cycle.

#### 3.6.3 Replacement or refill of chemical product

To replace the chemical product container perform the following procedure:

- Take the new product container.
- Switch off the machine.
- Open the compartment and remove the chemical product container. Replace the chemical product container removing the level sensor from the empty tank and put into the new one.
- Close the topper of the chemical product container and place it in the area for the storage of chemical substances.  
Close the technical compartment and switch on the machine.

	<b>ATTENTION</b>
	<p>The used chemical product can be dangerous if touched or inhaled. Before the use, read carefully the safety information supplied by the manufacturer of the chemical product and the label on the package.</p>
	<p>During the operations of replacement of chemical product container, use the appropriate tools for individual protection (chemical protective gloves, face masks for breathing, etc.).</p>
	<p>The access to the technical compartment, where are located the chemical product containers, is permitted only with keys and to the authorized personal.</p>

### 3.6.4 Warning

- For the maximum amount of product which can be used for washing cycle, follow the instructions for the product you are using.
- The quantity of supplied can be adjusted by following the directions given in chapter 12 – Chemical calibration.
- To ensure the efficiency of the chemical dosing system it is recommended to perform the calibration procedure every 6 months.
- To ensure the efficiency of the dispenser pumps for chemical products it is important to service them regularly as described in chapter 18.
- Use liquid chemical products only machine cannot function with powder detergent.
- For the dispose of the chemical detergent and his tank follow the instruction indicated on the technical and safety data sheet provided by the manufacturer.
- Check that type of chemical product is suitable for the specific washing program used.
- Don't place the chemical tank on the machine.

	<b>ATTENTION</b>
	<p><b>Before undertaking any sort of special maintenance or movement of machine, empty tanks and chemical dosing circuit from the chemical. It is advised to execute a treatment cycle without chemical.</b></p> <p><b>This procedure must be carried out in order to prevent contact of the chemical product with body parts and machine components that can be damage.</b></p>

### 3.6.5 Information

- The machine has been validated in accordance with the provisions of Standard UNI EN ISO 15883.
- The type test was carried out using the most widely known chemical products on the market, concerning the type of chemical products, the concentrations and the cycle parameters used you can ask the Manufacturer for details.

## 3.7 Connecting the discharge pipe

- The discharge pipe connection should be checked carefully.
- Use a discharge pipe suitable for organic and chemical materials and hot liquids.
- Caution: if the discharge pipe is clogged take great care when processing the water and avoid contact with hands, eyes, etc. In the case of contact rinse the parts concerned with plenty of water.
- These models are equipped with one pipe connected to drain with diameter 22 mm.

#### **CONNECTING DRAIN PIPE:**

The drain pipe is connected to the sewer network in the following manner:

- Identify the drain pipe and relative fittings, and assemble them.  
Make sure the seal gasket is installed correctly.
- Identify the drain manifold and connect the hose via the union and ring nut. Tighten the ring nut firmly.
- Insert the drain hose and clamp it in place.
- Insert the other end of the hose into the drain unit, fitting it properly and locking it in position.

#### **IT IS NECESSARY TO FOLLOW THESE INSTRUCTIONS FOR DRAIN CONNECTION**

- Drain pipe must be connected by using a clamp.
- Drain pipe must not present angles or irregular curving in its course.
- Drain point must be placed at the same height of the machine drain point or on the floor.

#### **FOLLOW CAREFULLY THESE INSTRUCTIONS AS A WRONG DRAIN CONNECTION CAN CAUSE THE BLOCK OF MACHINE.**

- Diameter of drain main must be of at least 25 mm.
- Avoid drain pipe extension.

	<b>ATTENTION</b>
	<ul style="list-style-type: none"> <li>• Drain must be done following International rules.</li> <li>• The manufacturer cannot be held responsible if an inaccurate use of machine causes pollution.</li>   <li>• If the discharge pipe is clogged take great care when processing the water and avoid contact with hands, eyes, etc. In the case of contact rinse the parts concerned with plenty of water.</li>   <li>• When the machine is connected to an exhaust ventilation system, the drain pipe should be positioned externally of the building, protected from any animal access, and make sure that it not causes any hazard.</li> </ul>

### 3.8 Water softener

The water softener built-in function is to reduce the anti-limescale quantity contained into the inlet water. If the machine is connected with hard water, the result is a rapid degeneration with lost in functions and performances. Regeneration must be done in order to maintain active ionic resins. For machines equipped with water softener, when installed, water hardness value must be introduced by entering into programming (PRG switch 5 seconds), at parameter P7.26 and introduce one of the following values:

<b>VALUE 10</b>	NO REGENERATION
<b>VALUE 15</b>	REG. every 30 cycles
<b>VALUE 20</b>	REG. every 25 cycles
<b>VALUE 25</b>	REG. every 21 cycles
<b>VALUE 30</b>	REG. every 18 cycles
<b>VALUE 35</b>	REG. every 15 cycles
<b>VALUE 40</b>	REG. every 12 cycles
<b>VALUE 45</b>	REG. every 9 cycles
<b>VALUE 50</b>	REG. every 6 cycles
<b>VALUE 55</b>	REG. every 3 cycles
<b>VALUE 60</b>	REG. present at each cycle (it is recommended for authorized people only).

The machine advise that it needs a regeneration with a written on display “salt loading”.

**ACTIONS:**

- Open the door
- Unscrew the plastic cap of salt box.
- Spill 0.5 Kg of common salt inside the box by using the appropriate funnel.  
**WARNING: during this operation, pay attention do not let fall sail outside box.**
- Closed the plastic cap.

After having introduce the basket, start with a normal washing cycle.  
 Machine regenerates automatically.

<p><b>WARNING:</b>  <b>Washing cycle made after “salt loading” will be longer and it seems that machine doesn’t work. During this phase, on display will appear “REGENERATION”.</b></p>
---



### 3.9 Drying air filtration (Optional)

The machines are standard equipped with an air filter of class 5 following rules EN 779.

**The filter's replacement is suggested after 100 working hours.**

The machine can be equipped also with a further absolute filter "HEPA H14" following rules EN 1822.

**The filter's replacement is suggested after 300 working hours.**

### 3.10 Ambient ventilation requirements

During the normal operation, the machine warms up itself dispersing heat and hot air increasing the humidity value; in the drying phase, these events increase. Therefore, in order to guarantee a comfortable environment with good temperature and humidity for the operator, it is necessary to prepare an air conditioning or air circulation system capable to balance the emissions reported in the installation plan.

The machines with drying system are equipped with an exhaust which can be connected to an external extraction system.



**A detail of the machine connections is shown on the installation plant and electrical wiring.**

## 4. CHECKS PRIOR TO START-UP

### 4.1 Introduction

The preliminary adjustments and controls are performed by a skilled technician, who has been specifically trained for this purpose.

### 4.2 Checks of safety systems

Indicative list of adjustments and checks of safety systems and devices to be carried out:

- Check the mains supply voltage;
- Check the efficiency of the emergency and machine shutdown devices (circuit breaker);
- Check the efficiency of the door opening safety micro switch;
- Check the operation of machine controls, especially the **START** and **STOP** commands.

### 4.3 General controls

Indicative list of general adjustments and checks to be made:

- Check proper execution of general supplies of the machine (electrical and plumbing);
- Ensure that the MACHINE OPERATOR is trained for its use;
- Check that the motors installed on the machine rotate in the correct direction (only for machines equipped with tri-phase power supply motors).

## 5. USING THE MACHINE (FOR THE USER)

### 5.1 Checks

Check the quantity of chemical additives present and top-up if necessary as described below:

- Obtain appropriate individual protection gear (gloves for protection from chemical substances, breathing protection masks, goggles etc.) and the new detergent container.
- Turn off the machine.
- Follow the instruction on sections 3.6.

#### ATTENTION:

**The chemical product which is used may be hazardous if touched or inhaled.**

**Prior to use, carefully read the safety information provided by the detergent supplier and the label applied to the package.**

### 5.2 Opening and closing the door

- The machine is fitted with an electric door lock to prevent it being opened when the machine is running.
- To open the door during a wash cycle, interrupt the cycle and remember that:
  1. The items inside the machine may be very hot.
  2. The entire wash cycle must be repeated.



#### 5.2.1 Door unlocking

In case of power fail or malfunctioning of door lock, it is possible to unlock and open the door by follow the procedure:

1. Identify the hole between the door and the cover panel (see the picture).
2. Insert the dedicated instrument.
3. Keep pushing the dedicated instrument. In this moment the door is unlocked and it is possible to open it.
4. To close the door, keep pushing the dedicate instrument as described on point 3.

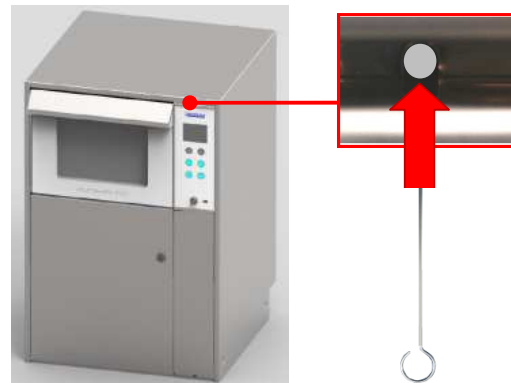

	<b>ATTENTION</b>
	<p><b>After performing the procedure described previously, remember that:</b></p> <ul style="list-style-type: none"> <li>• <b>The items inside the machine could be very hot and contaminated.</b></li> <li>• <b>The entire washing cycle must be repeat.</b></li> </ul>

## 5.3 Switching on

Turn on the machine following the procedure:

- Push the ON-OFF button on the control panel of machine.
- The control panel starts automatically.
- Check that there are no alarm message. In negative case remove it.



## 5.4 Preparation

### WARNING:

**Prior to placing instruments in the washer disinfectant, remove materials like composite, cement and amalgam following proper protocol and waste management.**

- Place the items to be washed inside the machine and position them carefully on the holder and in the rack.
- Items should not overlap.
- Receptacles should be positioned so that liquids can flow out easily.
- Tall or heavy items should be placed towards the middle of the basket if possible to facilitate washing.
- Make sure that nothing is blocking the arms and that they turn freely.
- Place the load uniformly in the basket.
- Check the patency of hollow instruments prior to their treatment in the machine.



	<b>CAUTION</b>
	<ul style="list-style-type: none"> <li>• The maximum load for each cycle is 8 Kg. (basket included).</li> <li>• <b>NEVER USE THE MACHINE WITHOUT BASKET!!!!</b></li> </ul>

Below are shown some example of basket's type available for the machine:

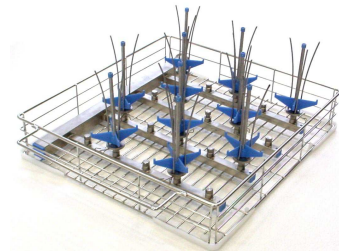
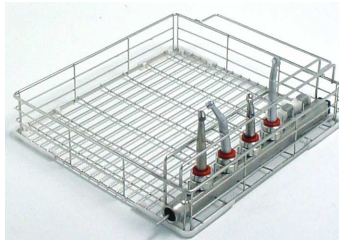

	<b>WARNING</b>
	<ul style="list-style-type: none"> <li>• Do never emptying any solid waste into the machine (excrement, toilet paper etc.). This will block the outlet system with pump and destroy the machine.</li> <li>• The treatment cycle has to be activated only if the basket is present into the machine or if it is used a basket equipped with an injection system.</li> <li>• Non observance, even in part, of the rule here indicated, can cause dangerous leakage of water from the door.</li> </ul>

## 5.5 Treatment of turbines and straight and angular hand pieces (opposed-angles)

Your machine can be equipped with a special basket studied specifically for washing hollow instruments, that need to be washed and for thermodisinfection both inside and outside the cavity.

### CODE: C84

The above-mentioned basket is equipped with special accessories suitable for inserting the hand pieces.

These supports are made in two parts, screwed together, between which there is a special filter.

There is a rubber adaptor in the top part, available in two different diameters for the hand pieces.

We recommend washing the filters in the fitting for supporting the turbines and the hand pieces on a weekly basis, or replacing them with new filters.

The following operations should be performed for the correct treatment of the turbines and straight and angular hand pieces:

- Prewash with cold water, to eliminate residues of blood and saliva.
- Wash at 45°C, adding mineral-free, neutral-PH, liquid detergent.
- Thermodisinfection at a temperature of 90°C for 1 minute, adding the additive for eliminating the residual water.

### PRECAUTIONS:

- Micromotors can't be subjected to thermodisinfection treatment.
- The thermodisinfection treatment can't be done with the 90°C program for 3 or 10 minutes.
- Never use powder detergents.

## 6. CONTROL PANEL AND SYMBOLS USED

The control panel with liquid crystal display is illustrated in the diagram. This panel makes the machine easy to use as it indicates the stage of the cycle in progress, the maximum temperature reached during disinfection and fault messages.

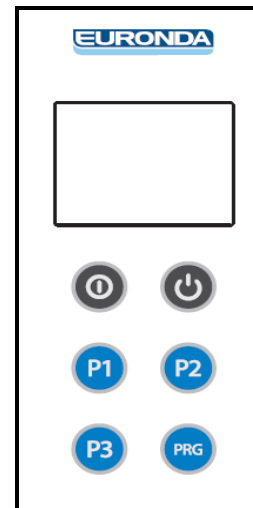

### 6.1 Control panel (loading side)

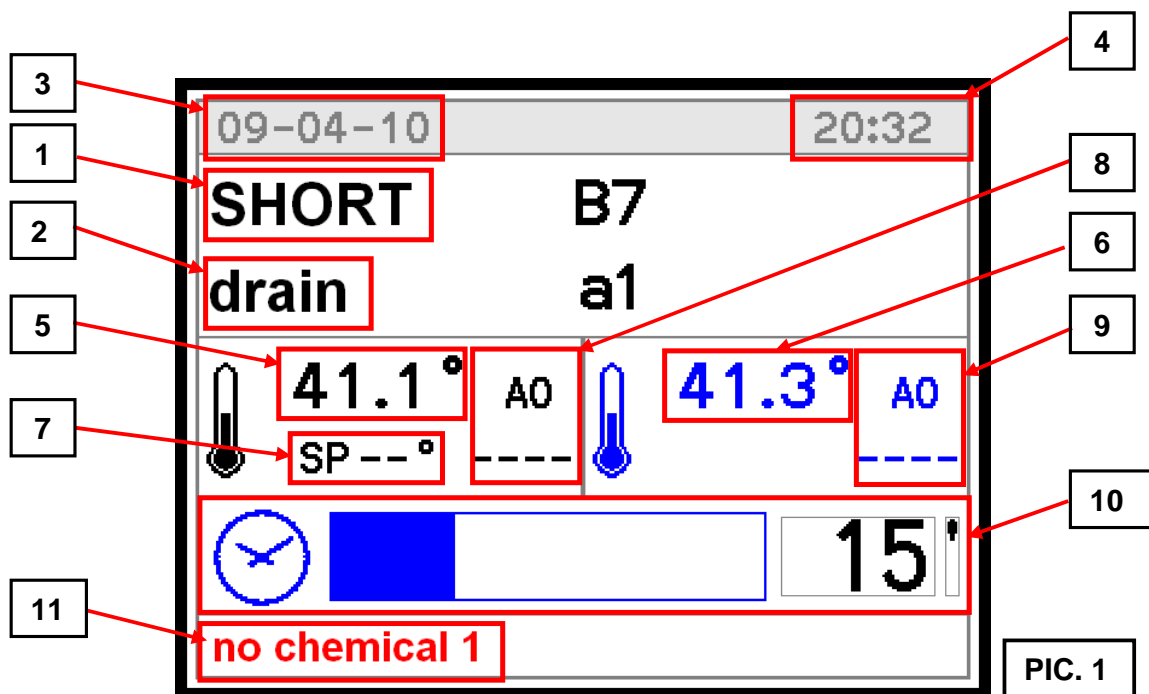

#### DISPLAY LCD

Display the following information:

- The program selected (1).
- The phase (2).
- The date and time (3 and 4).
- The control temperature (5) and recording temperature (6).
- The temperature of set-point for the current phase (7).
- The A0 value for control temperature (8) and for the recording temperature (9).
- The remaining time (10).
- Any failure of the machine (11).

Initially, while the machine is in the stand-by status, it displays the type of program selected, the temperatures, date and time.

By pressing one of the programme switch (**P1**, **P2** or **P3**), the display shows the program selected at the top and at the bottom in red: "press start" or "door open" or any other warnings.

By pressing the switch **P+** it is possible to scroll all the programs available.

## LED

The keys of the glass display are touch-sensitive and backlit.

## BUZZER

The buzzer sounds each time a key is pressed and intermittently in the case of a machine Shutdown, according to the setting of parameters **P1.7**, **P1.8**, **P1.9 (loading side)**, **P1.10**, **P1.11**, **P1.12 (unloading side)** through which is possible to set its volume.

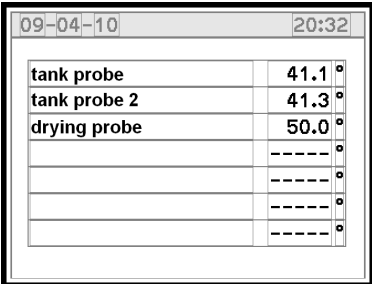
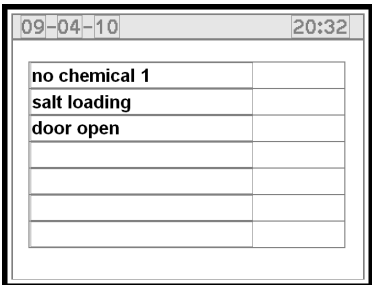
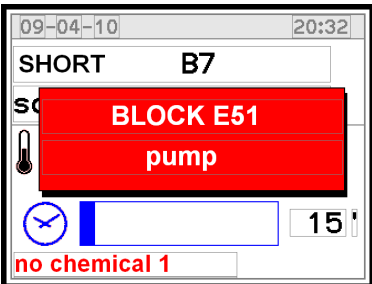
<p><b>PIC. 2</b></p> 	<p>During the cycle, by pressing the switch PRG it is possible to display the screen that shows the various temperatures of the device and the values associated to the transducers (pressure, conductivity) (Pic. 2).</p>
<p><b>PIC. 3</b></p> 	<p>Pressing it twice it is possible to display the screen with the list of alarms and warnings appears during the cycle (Pic.3).</p>
<p><b>PIC. 4</b></p> 	<p>In case of block, a window appears which indicates the identification code for the alarm and a brief description as shown in Pic.4.</p>
<p>In case of failure, which does not lead to a block, (lack of chemical) a message is shown at the bottom of the screen (Pic.1 point 11) or by pressing the PRG switch twice as shown in Pic.3.</p>	

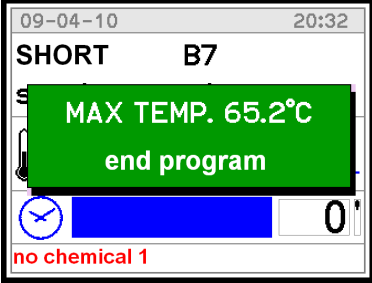
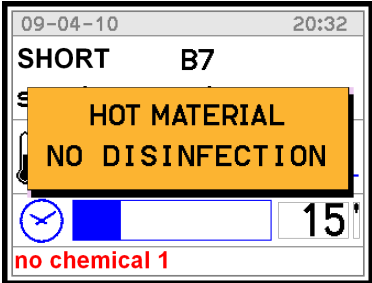
<p><b>PIC. 5</b></p> 	<p>At the end of the cycle, a special window appears as shown in Pic.5.</p>
<p><b>PIC. 6</b></p> 	<p>In case of stop of the cycle, a window appears with a message that warns of the disinfection lack (Pic.6).</p>

### 6.1.1 Keys

BUTTON	DESCRIPTION
<b>START</b>	After having selected the programme to be run pressing this button the cycle is started.
<b>STOP</b>	This switch interrupts the cycle in progress, the card interrupts the process, displays a message indicating that disinfection did not take place, keeps the door locked and if necessary indicates a high temperature inside the chamber. To return the machine to normal conditions the button must be pressed once more.
<b>P1</b>	Select “ <b>SHORT CYCLE</b> ”.
<b>P2</b>	Select “ <b>STANDARD CYCLE</b> ”.
<b>P3</b>	Select “ <b>INTENSIVE CYCLE</b> ”.
<b>PRG</b>	Keep pressed for five seconds during Wait or Shutdown to display the Menu.
<b>USB</b>	On the control panel board there is an USB port that allows the machine programming and data saving.
<p><b>THE ACCESS TO THE PROGRAMMING MODE IS RESTRICTED ONLY TO AUTHORIZED AND SKILLED TECHNICIANS WHICH ARE SUPPLIED WITH THE PASSWORD.</b></p>	



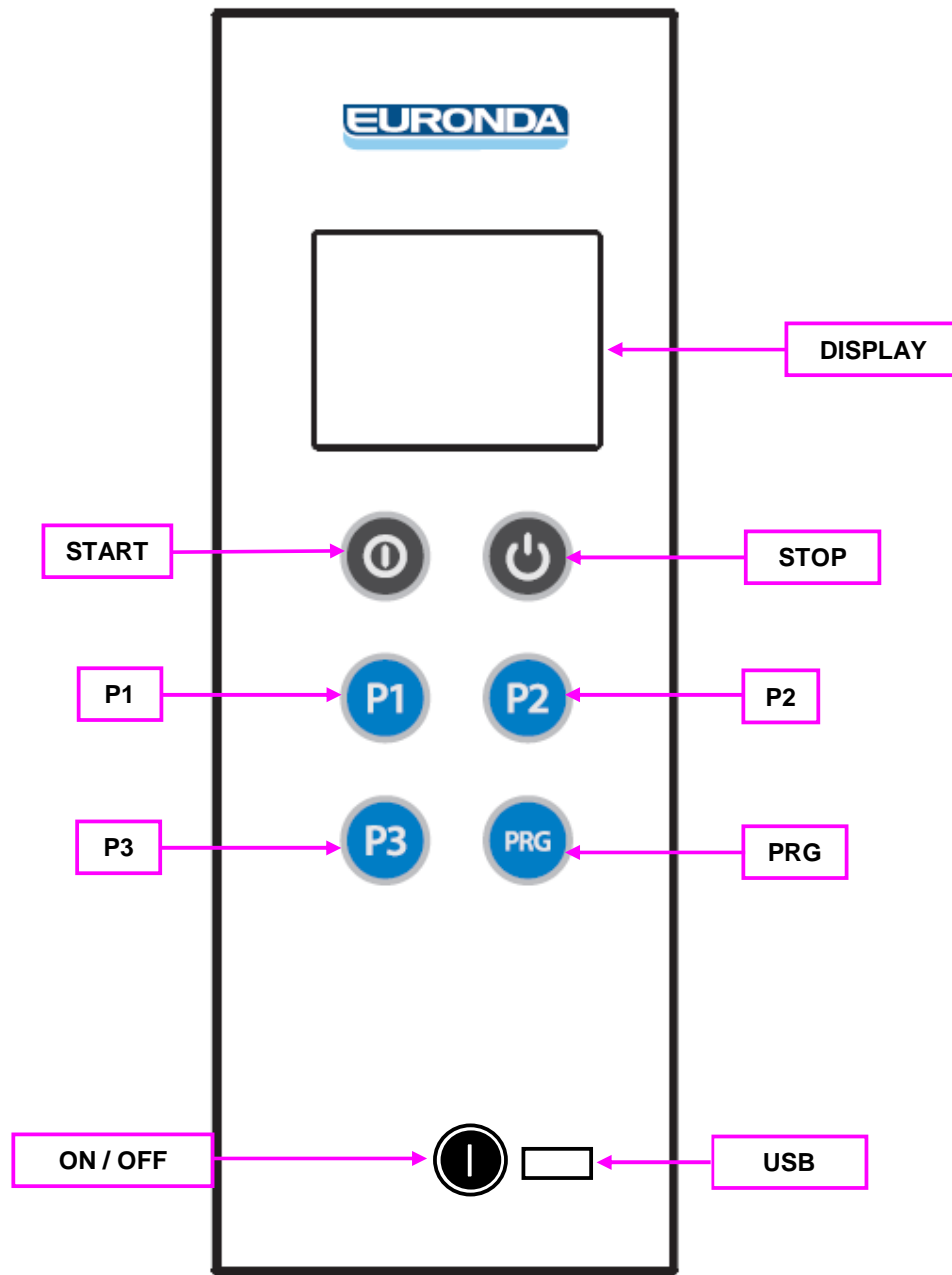

# 7. WASHING PROGRAMMES

The machine has three main washing programs in according to the necessity:

<b>RAPID PROGRAMME</b>	<b>P1</b>	Suitable for lightly soiled items.
<b>STANDARD PROGRAMME</b>	<b>P2</b>	Suitable for moderately soiled items.
<b>INTENSIVE PROGRAMME</b>	<b>P3</b>	Suitable for heavily soiled items.

The machine has several washing programmes. To enable programmes, follow the procedure:

**Enter the menu:** Program selection → Insert password → Select washing program → Enable or disable washing program.

## 7.1 Pre-programmed cycles

It is possible to select washing programmes by pushing **PRG**. The programs available to the user are as follows:

PROGRAM	PHASE														
	PREWASHING	WASHING										RINSING		THERMODIS.	DRYING
	Water - Tempo	Water Temp.-Time Chemical	Water Temp.-Time Chemical	Water Temp.-Time Chemical	Water Temp.-Time Chemical	Water Temp.-Time Chemical	Water Temp.-Time Chemical	Water Temp.-Time Chemical	Water Temp.-Time Chemical	Water Temp.-Time Chemical	Water Temp.-Time Chemical	Water Temp.-Time	Water Temp.-Time	Water Temp.-Time Chemical	Tempor. Time
BabyBot.S	COLD - 120 s	WARM 60 °C - 180 s ALK. - 3 %	WARM 30 s LUB. - 1 %	60 °C - 120 s								DEMI 60 s		DEMI 90 °C - 180 s LUB. - 0.5 %	120°C 720 s
BabyBot.I	COLD - 120 s	WARM 65 °C - 360 s ALK. - 3 %	WARM 30 s ACD 3 %	60 °C - 120 s								DEMI 60 s		DEMI 90 °C - 180 s	120°C 1440 s
BGA30x3 St		DEMI 90 °C - 180 s ALK. - 3 %	WARM 30 s ADD - 1 %	60 °C - 60 s										DEMI 75 °C - 180 s	120°C 2040 s
BGA30x10 I		DEMI 90 °C - 600 s ALK. - 3 %	WARM 30 s ACD - 1 %	60 °C - 60 s								DEMI 60 s		DEMI 75 °C - 180 s	120°C 840 s
BLOOD Th.	COLD - 120 s	WARM 60 °C - 180 s ALK. - 3 %	WARM 30 s ACD - 1 %	60 °C - 60 s								DEMI 60 s		DEMI 90 °C - 180 s LUB.	120°C 840 s
BL.Th.Int	COLD - 120 s	WARM 65 °C - 360 s ALK. - 3 %	WARM 30 s ACD - 1 %	0 °C - 60 s								WARM 60 s	DEMI 0°C - 60 s	DEMI 90 °C - 600 s	120°C 840 s
SHORT		WARM 50 °C - 180 s ALK. - 3 %	WARM 30 s ACD - 1 %	60 °C - 60 s										DEMI 90 °C - 60 s	120°C 840 s
STANDARD	COLD - 120 s	WARM 60 °C - 180 s ALK. - 3 %	WARM 30 s ACD - 1 %	0 °C - 60 s										DEMI 90 °C - 60 s	120°C 1440 s
INTENSIVE	COLD - 120 s	WARM 65 °C - 360 s ALK. - 3 %	WARM 30 s ACD - 1 %	60 °C - 60 s								DEMI 60 s		DEMI 90 °C - 60 s	120°C 1440 s
MICROBIOL		DEMI 90 °C - 180 s ALK. - 3 %	WARM 30 s ACD - 1 %	60 °C - 60 s								DEMI 60 s		DEMI 75 °C - 120 s	840°C 720 s
MICROB.Int		DEMI 90 °C - 600 s ALK. - 3 %	WARM 30 s ACD - 1 %	60 °C - 60 s								WARM 60 s	DEMI 60 s	DEMI 75 °C - 180 s	120°C 840 s
Veget.Oil	COLD - 120 s	DEMI 90 °C - 60 s ALK. - 3 %	WARM 30 s ACD - 1 %	60 °C - 60 s								WARM 60 s	DEMI 60 s	DEMI 75 °C - 180 s	120°C 840 s
Miner.Oil		WARM 75 °C - 120 s ALK. - 3 % SODA - 3 %	DEMI 5 s ALK. - 3 %	90 °C - 600 s ACD - 3 %	WARM 30 s ACD - 1 %	60 °C - 60 s	WARM 30 s ACD - 1 %	60 °C - 60 s	WARM 30 s ACD - 1 %	60 °C - 60 s		WARM 30 s	DEMI 60 s	DEMI 75 °C - 180 s	120°C 840 s
SPECIAL		WARM 80 °C - 120 s ALK. - 3 % SODA - 3 %	DEMI 5 s ALK. - 3 %	90 °C - 180 s ACD - 3 %	WARM 30 s ACD - 1 %	60 °C - 60 s	WARM 30 s ACD - 1 %	60 °C - 60 s	WARM 30 s ACD - 1 %	60 °C - 60 s		WARM 60 s	DEMI 60 s	DEMI 75 °C - 30 s	120°C 840 s
PetrolFuel		DEMI 5 s ALK. - 3 % SODA - 3 %	WARM 90 °C - 600 s ACD - 3 %	DEMI 5 s ALK. - 3 %	90 °C - 600 s ACD - 3 %	DEMI 5 s ALK. - 3 %	90 °C - 600 s ACD - 3 %	WARM 30 s ACD - 1 %	60 °C - 90 s	WARM 30 s ACD - 1 %	60 °C - 60 s	WARM 60 s		DEMI 75 °C - 180 s	120°C 840 s
STANDARD75	COLD - 120 s	WARM 75 °C - 120 s ALK. - 3 %	WARM 30 s ACD - 1 %	60 °C - 60 s									DEMI 60 s	DEMI 75 °C - 180 s	120°C 840 s
CHEM. DISI		WARM 60 °C - 120 s ALK. - 3 %	WARM 30 s ACD - 1 %	60 °C - 60 s	WARM 60 s		WARM 60 °C - 300 s DIS. - 3 %							DEMI 60 °C - 60 s	120°C 840 s
ENZYMATIC	COLD - 120 s	WARM 35 °C - 180 s	60 °C - 360 s ALK. - 3 %	DEMI 60 °C - 60 s										DEMI 70 °C - 180 s	120°C 840 s
DRYING															120°C 840 s
PREWASH	COLD - 120 s														

DOSING PUMP	CHEMICAL PRODUCT
ALK.	ALKALINE or NEUTRAL DETERGENT
ACD	ACID or NEUTRALIZER
LUB.	LUBRICANT or RINSE AID - ACD
DOS. 4	SODA or DISINFECTANT

## 7.2 Phase parameters

### 7.2.1 Drain phase

- Cold water time for rinsing (sec)
- Functioning time of tank pump (sec.)
- Drain cooling choice (yes/no)

### 7.2.2 Prewashing phase

- Water type 1
- Water type 2
- Water total litres
- Conductivity
- Chemical type 1
- Dosing quantity of product 1
- Chemical type 2
- Dosing quantity of product 2
- Phase time (sec.)

### 7.2.3 Treatment phase

- Water type 1
- Water type 2
- Water total litres
- Conductivity
- Chemical type 1
- Dosing quantity of product 1
- Min. temperature for filling up of 1st chemical
- Chemical type 2
- Dosing quantity of product 2
- Min. temperature for filling up of 2nd chemical
- Phase time (sec)
- Phase temperature set point

### 7.2.4 Drying phase

- Fan starting type at low speed (sec)
- Fan starting time at high speed (sec.)
- Phase temperature set point

## 8. MACHINE STATUS

When there is a voltage drop in the line and the tension is restored, the machine memorises the status that was present at the time of the voltage drop.

When the tension is restored the machine normally returns to "wait" mode.

### 8.1 Wait

The machine is ready to start a cycle.

The diagnostics are active. If necessary the display indicates that the door is open or gives warning messages: no detergent, no limescale remover, memory full (historic data) or high temperature inside chamber.

### 8.2 Cycle

Cycle mode is entered by pressing the Start key, this command is only accepted if the machine is in wait mode and the door is closed.

The cycle carries out the foreseen stages.

The diagnostics and regulators are active.

The user interface gives information concerning the stage in progress.

### 8.3 Shutdown

The diagnostics have detected a fault that causes the machine to shutdown, the cycle is suspended and the door remains locked.

The fault is indicated on the display and the user interface is ready for the door release sequence and the Reset procedure to restore the machine to Wait (see reset procedure).

## 9. SPECIAL FEATURES

### 9.1 Power failure

When tension is restored after a power failure during Preparing, Wait or Shutdown, the card returns to the previous programme.

When tension is restored following a power failure with a cycle in progress, the card shuts down the machine (power failure), indicates that the cycle has been interrupted and waits for the reset procedure to be carried out.

### 9.2 Reset procedure

In the event of a Shutdown or when the stop key is pressed with a cycle in progress, the door remains locked.

To open the door the door release sequence must be carried out from the keyboard as follows:

1. Press the **STOP**  and **START**  switch together and keep pressed for 5".
2. LCD display indicating switch procedure.
3. Press the programme **P2**  switch followed by the program **P1**  switch.
4. The machine is reset and returns to standby.

#### N.B.:

If the machine shutdown persists due to a fault in one of its components (e.g.: faulty probe, unsuitable levels, etc.), the door is released and the machine remains inactive.

Seek technical assistance.

# 10. WORK PROCEDURES

## 10.1 Introduction

The machine was construct only for washing and thermal disinfection of orthodontic instruments, trays and objects normally used in orthodontic studios, hospital wards, assisted living centres, and so forth.

It is therefore subject to constant contact with aggressive detergents and with contaminated instruments.

For this reason it is necessary to provide some useful instructions for the operators who will be using it.

## 10.2 Instructions to personnel

**The machine operator**, in normal operating conditions, is not subject to risks if he works safely using suitable means of protection.

In order to work safely the operator must:

- Carefully comply with the instructions set forth in this manual.
- Use safety devices appropriately and with care, as well as group and individual safety gear provided in the workplace.
- Personally take action, or inform appropriate persons in the event of deficiencies in the aforementioned devices and means, as well as any hazardous conditions which he may become aware of, taking action directly in urgent cases within their scope of responsibilities and abilities to eliminate or reduce the deficiencies or hazards.

**The maintenance technicians**, in normal operating conditions, are not subject to risks if they work safely using suitable means of protection.

In order to work safely the maintenance technician must:

- Carefully comply with the instructions set forth in this manual.
- Use safety devices appropriately and with care, as well as group and individual safety gear provided in the workplace.
- Use special care in making repairs or replacing mechanical parts (e.g. drain pump, etc.) on malfunctioning machines which have not completed the thermal disinfection cycle.

## 10.3 Decontamination procedures

When making repairs or replacing mechanical parts (e.g. drain pump, heating element, etc.) on malfunctioning machines that have not completed the thermal disinfection cycle, before undertaking any sort of maintenance on the internal parts of the machine, the disinfection procedure must be carried out in order to eliminate any pathogenic residues and protect operators who come into contact with the machine from the risk of infection.

The decontamination procedure must be performed by the system operator, who must be equipped with all provided individual protection gear.

### **MACHINE STATUS:**

The machine must not be powered electrically and the dedicated disconnected device must be in the OFF position.

The person performing the task this operation.

### **SAFETY SYSTEMS TO BE ADOPTED:**

The operation must be carried out in compliance with standards governing the use of disinfectant substances used (see technical information for the product being used, provided by the manufacturer), in compliance with standards concerning contact with parts of the machine which may be contaminated by pathogenic materials and with use of individual protection gear.

### **MODE OF INTERVENTION:**

If possible, dry run a cycle for thermal disinfection of the wash chamber.

Open the wash chamber door and spray evenly with a suitable disinfectant.

Cover all internal parts as well as any basket and the instruments it may contain.





Wait for the amount of time required for disinfection (see technical information for the disinfectant product).

When performing maintenance on parts of the machine which have not been reached by the disinfectant, take appropriate precautions and use suitable safety gear.

# 11. MENU

## 11.1 Menu plan

To enter the menu keep the **PRG**  key pressed for 5 seconds.

- Press **P1**  and **P2**  programme switch to scroll through the menu:
- Press **START**  to confirm selection, press **STOP**  to exit the menu and return to Wait or Shutdown mode.

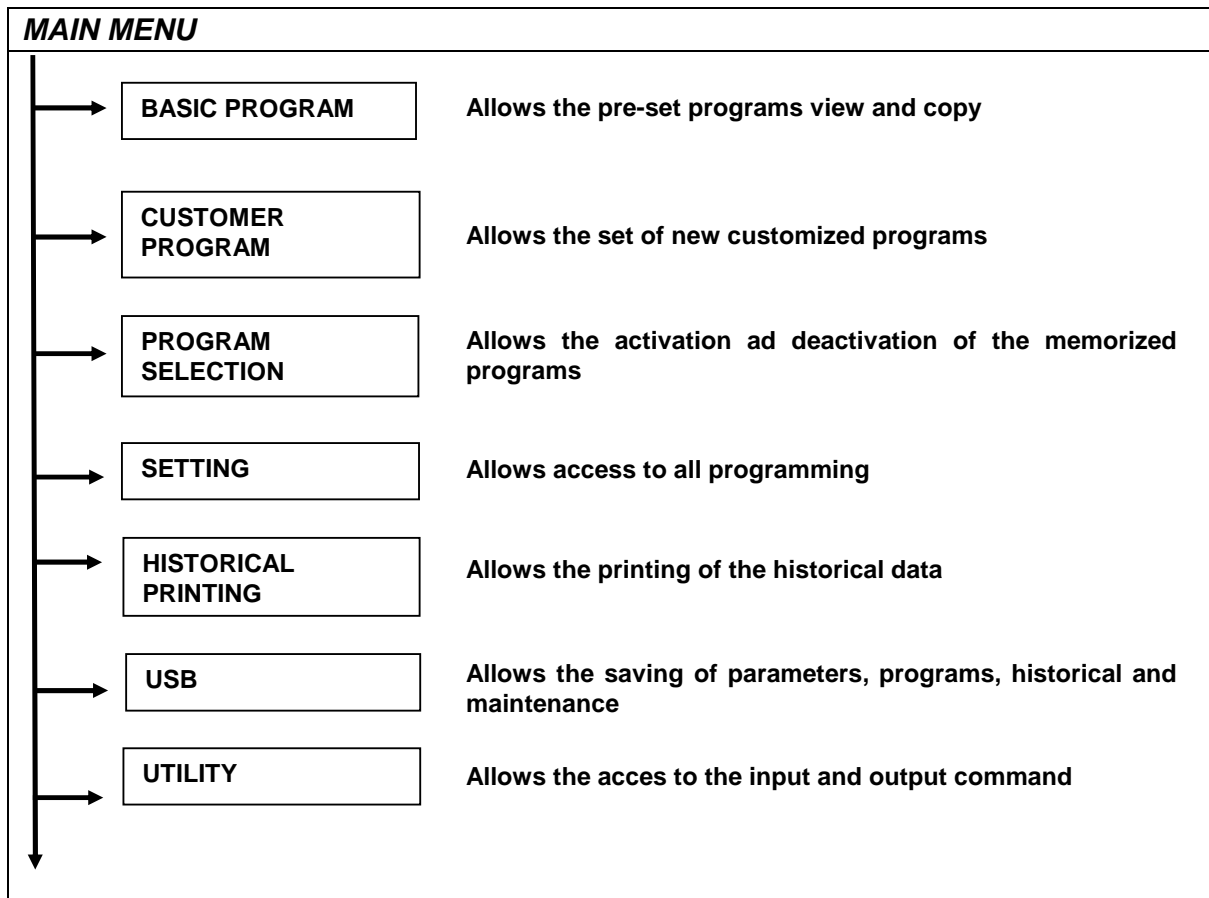

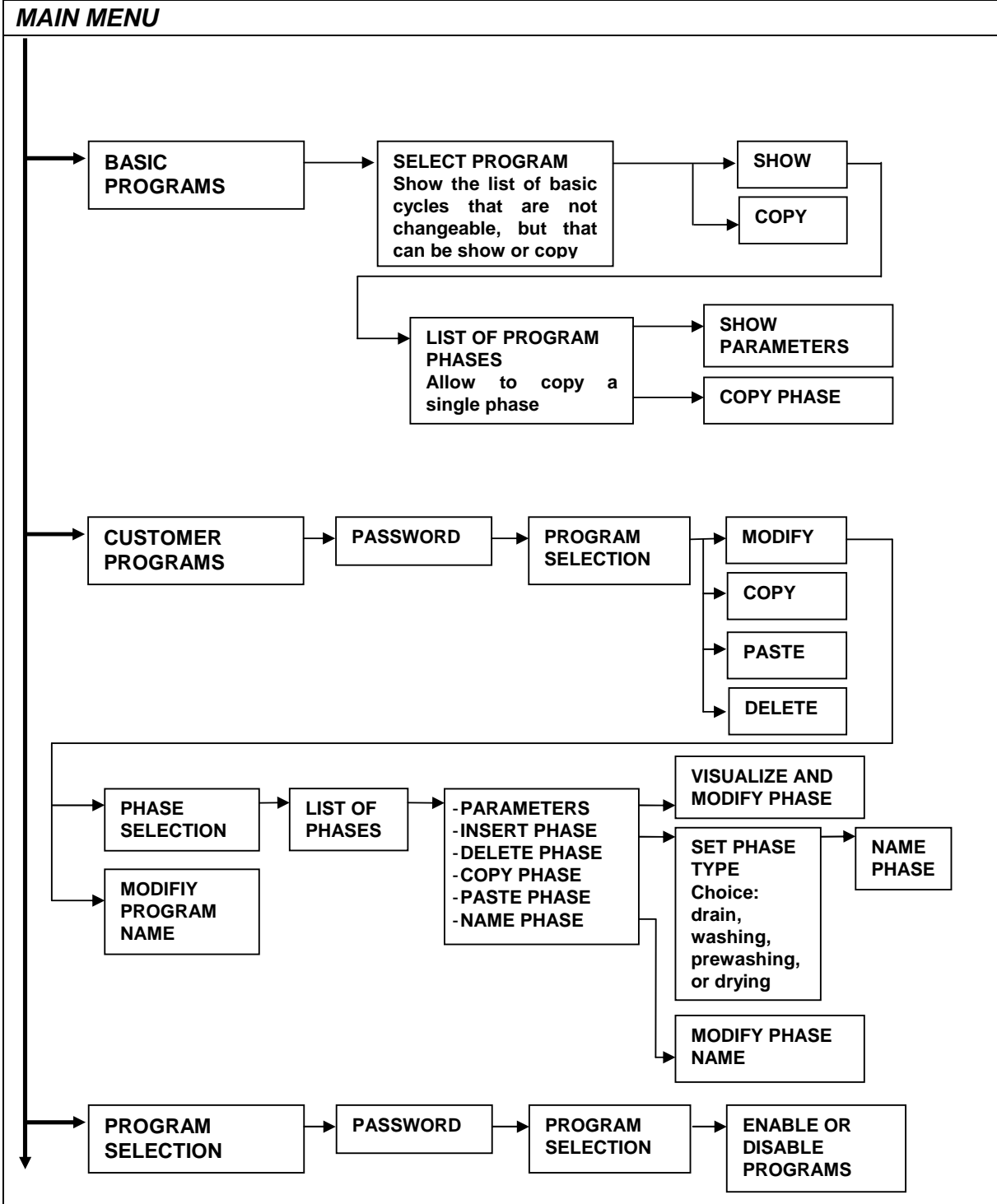

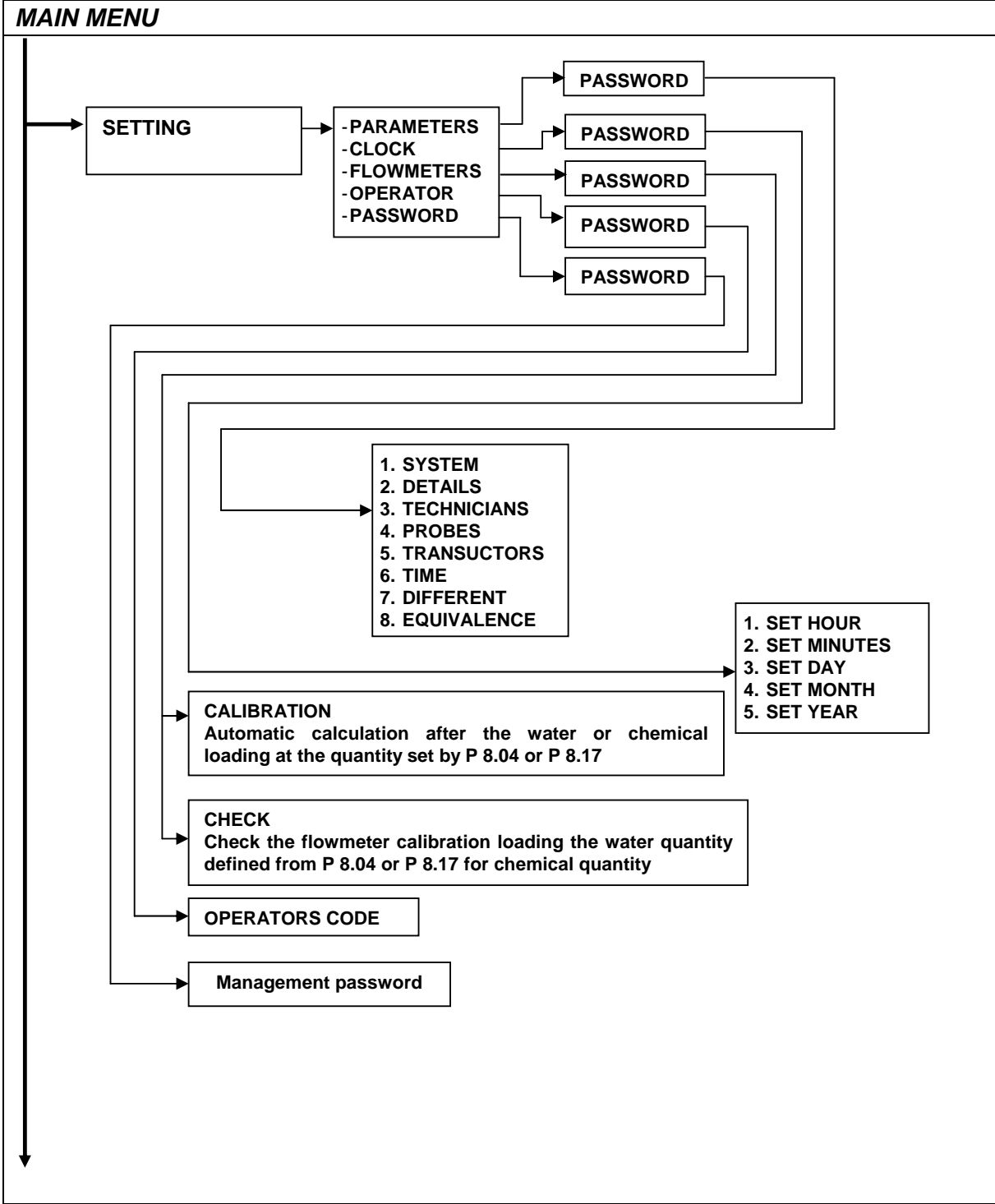



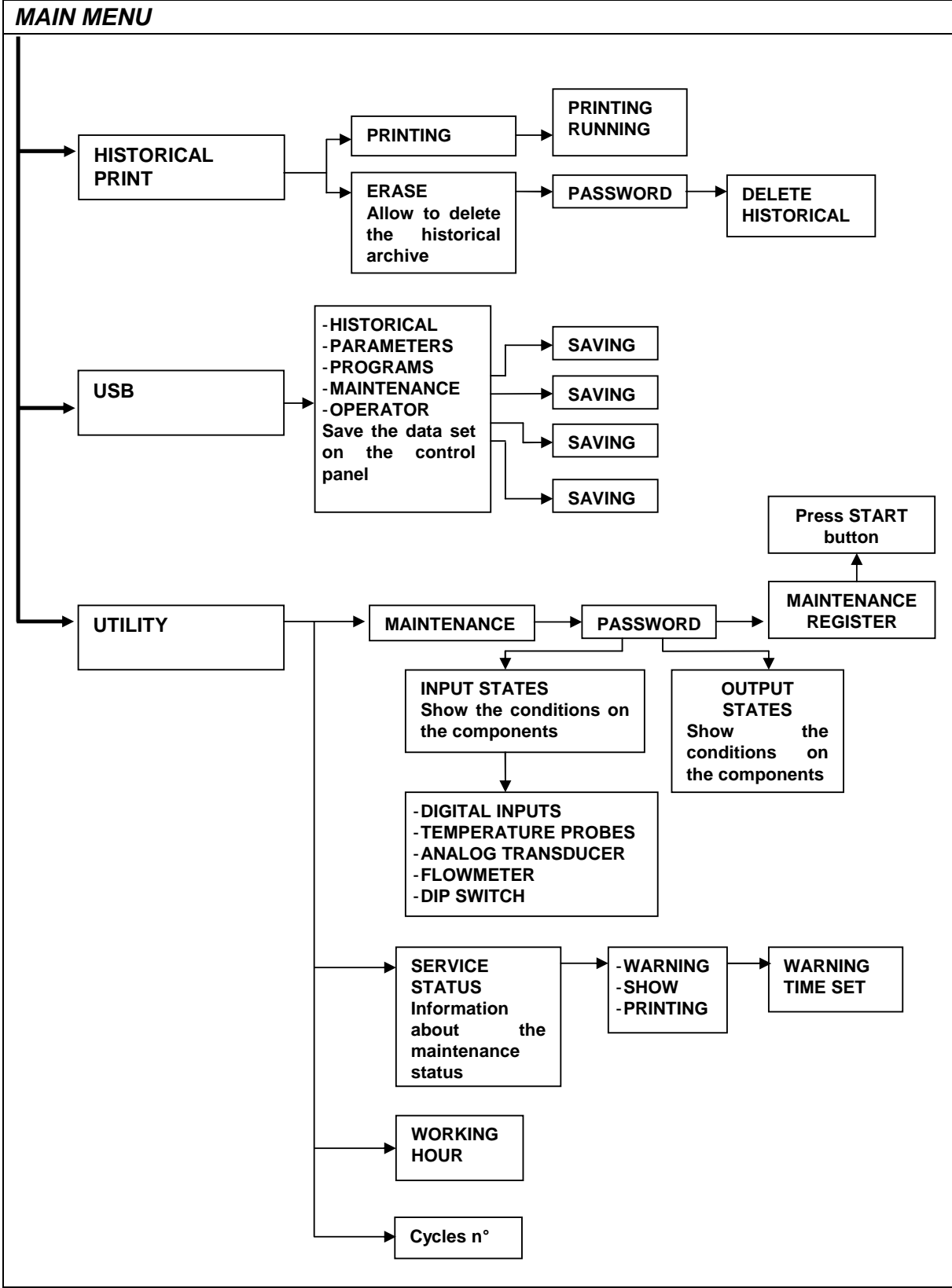

## 11.2 Parameters settings

To select parameters please follows this special procedure.

To set parameters, a password will be requested, which is inserted using **P1** and **P2** buttons.

If an incorrect password is entered the menu is closed immediately.

By pressing **P1** and **P2** buttons it is possible to scroll through parameters.

Press **START** button to access at modify of parameter and use keys **P1** and **P2** to increase or decrease the various parameter values.

If no parameters are varied, you can exit parameter setting with **STOP** key.

**WARNING:**  
IT IS ALLOWED TO ENTER INTO PLANNING MENU TO AUTHORISED TECHNICIAN, WITH PASSWORD ONLY.

THE PASSWORD MUST BE REQUESTED FROM THE MANUFACTURER.

## 11.3 Parameter list

Sw version 7.04						
CATEGORY	SECTION	PARAMETER	DESCRIPTION	MIN	MAX	UDM
<b>SYSTEM DATA</b>						
MACHINE	1	1	User name (16 character)	,	~	CHAR_STR
CYCLE	1	2	Operator identification	0	1	YES_NO
PRINT OUT	1	4	Graphic print out at the end of the cycle (0: no print out, 1: graphic print out 2: table print out, 3: print out only on USB)	0	3	NUM
PRINT OUT	1	5	Print out results of the cycle being carried out (events, consumption,...)	0	1	YES_NO
KEYBOARD	1	7	Buzzer volume key tone loading side (0: buzzer switched off)	0	50	NUM
KEYBOARD	1	8	Buzzer volume end of cycle warning loading side (0: buzzer switched off)	0	50	NUM
KEYBOARD	1	9	Buzzer alarm volume loading side (0: buzzer switched off)	0	50	NUM
KEYBOARD	1	10	Buzzer volume key tone unloading side (0: buzzer switched off)	0	50	NUM
KEYBOARD	1	11	Buzzer volume end of cycle warning unloading side (0: buzzer switched off)	0	50	NUM
KEYBOARD	1	12	Buzzer alarm volume unloading side (0: buzzer switched off)	0	50	NUM
KEYBOARD	1	13	Show the A0 value on the display	0	1	YES_NO

Sw version 7.04						
CATEGORY	SECTION	PARAMETER	DESCRIPTION	MIN	MAX	UDM
CYCLE	1	16	Enable warning for full historical cycle: (0= no warning, 1= warning without cycle start block, 2= warning and block the cycle start). The warning will be reset if the historical cycle will be printed or on USB	0	2	NUM
KEYBOARD	1	18	Maximum mistakes number on password input into the protected menu (0: function disabled)	0	100	NUM
MACHINE DATA						
MACHINE	2	1	Machine model (8 characters)	,	~	CHAR_STR
MACHINE	2	2	Machine matriculation number (5 characters)	0	9	CHAR_NUM
MACHINE	2	3	Test day	1	31	LINK_NUM
MACHINE	2	3	Test month	1	12	LINK_NUM
MACHINE	2	3	Test year	10	99	LINK_NUM
KEYBOARD	2	4	Select language	0	7	LANG_MSG
MACHINE	2	5	Station number	0	99	NUM
MACHINE	2	6	Client/distributor (16 characters)	,	~	CHAR_STR
KEYBOARD	2	7	Select font group (0: European, 1: European+Japanese, 2: European+ Cyrillic)	0	2	NUM
KEYBOARD	2	8	Unit of measurement (0: International, 1: American)	0	1	NUM
TECHNIQUES						
DOORS	3	1	Double door machine	0	1	YES_NO
PT1000	3	2	Activate regulation probe (chamber probe 2) (0: no, 1: on a separate regulation form, 2: on standard form)	0	2	YES_NO
PRINT OUT	3	3	Printer on board (0: none, 1: on board, 2: on both board 1 and 2 (redundant print for machines that manage it))	0	2	YES_NO
CYCLE	3	4	Activate after cycle has been interrupted due to energy failure (0: when phase restarts, 1: from the beginning of the cycle, 2: from when cycle failed)	0	2	MSG_START_CYCLE
CYCLE	3	5	Activate after cycle has been interrupted due to alarm (0: when phase restarts, 1: from the beginning of the cycle, 2: from when cycle failed)	0	2	MSG_START_CYCLE
CHEMICAL	3	6	Set in case of lack of chemical additives (0: warning, 1: alarm with machine block)	0	1	MSG_WARN_ALARM
DOORS	3	7	Pass-through function enabling	0	1	YES_NO
BOILER	3	8	Boiler on board (demineralised water heater)	0	1	YES_NO
PUMPS	3	13	Washing arm pump pressure switch	0	1	YES_NO
DRAINING	3	18	Cold water solenoid valve for drainage cooling	0	1	YES_NO
DRAINING	3	19	Special draining solenoid valve (0: no, 1: 2nd draining for clean water, 2: draining water on chamber in tank 2, 3: draining water on chamber in tank 4 and recovery in tank 2, 4: draining water on chamber in tank 4)	0	1	YES_NO
DRYER	3	20	Activate dryer (0: no, 1: normally selected, 2: normally not selected, 3: always activated)	0	3	NUM
PUMPS	3	23	Transducer (4-20 mA) to control impeller pump pressure	0	1	YES_NO
WATER	3	25	Analogue probe (4-20 mA) for conductivity	0	1	YES_NO
DOORS	3	31	Door safety switch presence for UL conformity	0	1	YES_NO
DOORS	3	32	Absence of door block (manual single door configuration)	0	1	YES_NO

Sw version 7.04						
CATEGORY	SECTION	PARAMETER	DESCRIPTION	MIN	MAX	UDM
PT1000	3	33	Drying probe presence	0	1	YES_NO
EQUIPMENT	3	35	Enable power reduction	0	1	YES_NO
WATER	3	37	Absence of demineralised water (1: load cold water in its place)	0	1	YES_NO
CYCLE	3	51	Number of automatic cycle repetition for washing test (0: none)	0	100	NUM
PROBE PT 1000						
PT1000	4	1	Offset calibration chamber probe1 at a 0°C	-9,9	9,9	DEGRÉE
PT1000	4	2	Offset calibration chamber probe1 at a 100°C	-9,9	9,9	DEGRÉE
PT1000	4	3	Offset calibration chamber probe2 at a 0°C	-9,9	9,9	DEGRÉE
PT1000	4	4	Offset calibration chamber probe2 at a 100°C	-9,9	9,9	DEGRÉE
PT1000	4	5	Offset calibration dryer probe at a 0°C	-9,9	9,9	DEGRÉE
PT1000	4	6	Offset calibration dryer probe at a 100°C	-9,9	9,9	DEGRÉE
PT1000	4	7	Offset calibration boiler or tank1 probe at 0°C	-9,9	9,9	DEGRÉE
PT1000	4	8	Offset calibration boiler or tank1 probe at 100°C	-9,9	9,9	DEGRÉE
ANALOGUE TRANSDUCERS						
PUMPS	5	1	Pressure scale lower limit	-1	P5.02	BAR
PUMPS	5	2	Pressure scale upper limit	P5.01	3	BAR
WATER	5	3	Conductibility scale lower limit	0	P5.04	uS_cm
WATER	5	4	Conductibility scale upper limit	P5.03	20000	uS_cm
TIME DATA						
CHAMBER	6	1	Max time for 1°C increase in the chamber	0	999	SEC
BOILER	6	2	Max time for 1°C increase in the boiler	0	999	SEC
DRAINING	6	3	Maximum drainage time	0	999	SEC
DRAINING	6	4	Maximum drainage time with rinsing water loaded	0	999	SEC
WATER	6	5	Maximum waiting time for cold water filling to level in the chamber or waiting time for water load/unload on tank3.	0	999	SEC
WATER	6	7	Maximum waiting time for demineralised water filling to level in the chamber or waiting time for water load/unload on tank1 or load on boiler.	0	999	SEC
WATER	6	9	Maximum waiting time for cold + demi water filling	0	999	SEC
CHEMICALS	6	12	Maximum waiting time for chemical products flowmeter impulse	0	99,9	SEC
DOORS	6	13	Maximum door block opening time	0	99,9	SEC
DOORS	6	14	Maximum door block closing time	0	99,9	SEC
PUMPS	6	17	Delay in reading pump pressure switch	0	99,9	SEC
DRIER	6	19	Delay in reading ventilator pressure switch (0: diagnostics deactivated)	0	99,9	SEC
CHEMICALS	6	20	Filling time for chemical product1 dosing system	0	999,9	SEC
CHEMICALS	6	22	Filling time for chemical product3 dosing system	0	999,9	SEC
BOILER	6	24	Time taken after cycle inactivity for switching off boiler	0	24	HOURS
DRAINING	6	25	Time taken for activating cooling drainage solenoid valve	0	99,9	SEC
PUMPS	6	28	Fractional pump OFF time	0	99,9	SEC
PUMPS	6	29	Fractional pump ON time	0	99,9	SEC
DRAINING	6	30	Draining cycle OFF time	0	99,9	SEC
DRAINING	6	31	Draining cycle ON time	0	99,9	SEC

Sw version 7.04						
CATEGORY	SECTION	PARAMETER	DESCRIPTION	MIN	MAX	UDM
DRYER	6	38	Ventilator switch-off delay (post-ventilation)	0	999	SEC
BOILER	6	39	Boiler loading delay after full level activation	0	99	SEC
DOORS	6	40	Door1 block opening delay ON after stop block activation	0	9,9	SEC
DOORS	6	41	Door1 block closing delay ON after stop block activation	0	9,9	SEC
DOORS	6	42	Door2 block opening delay ON after stop block activation	0	9,9	SEC
DOORS	6	43	Door2 block closing delay ON after stop block activation	0	9,9	SEC
REGENERAT.	6	44	Pause time during regeneration	0	999	SEC
REGENERAT.	6	45	Water loading time for regeneration	0	999	SEC
REGENERAT.	6	46	Cold water loading time for regeneration rinsing	0	999	SEC
PRINT OUT	6	47	Sampling time for chamber temperature and pressure trends	5	99	SEC
CYCLE	6	48	Time in months to warn about forthcoming maintenance service since the last one carried out	1	99	NUM
CYCLE	6	49	Increase in machine hours to warn about the next maintenance service since the last one carried out	1	9999	HOURS
VARIOUS DATA						
DRAINING	7	1	Number of fractioned draining cycles	1	99	NUM
BOILER	7	2	Boiler or tank 1 stand-by temperature	0	80	DEGREE
BOILER	7	3	Boiler or tank 1 cycle temperature	0	80	DEGREE
CHAMBER	7	7	Min. quantity of water in the chamber	0	P7.08	LITRES
CHAMBER	7	8	Max. quantity of water in the chamber	P7.07	99	LITRES
CHAMBER	7	11	Max. chamber probe temperature difference	0	99	DEGREE
CHAMBER	7	12	Min. temperature for max. chamber temperature probes difference control	0	95	DEGREE
DRYER	7	13	Min temperature to be reached by dryer (ventilated)	0	100	DEGREE
PRE-WASH	7	14	Max. permitted temperature in pre-wash phase	0	95	DEGREE
DRAINING	7	15	Min. temperature for drain cooling activation	0	100	DEGREE
WATER	7	19	Max. conductivity of water in chamber	0	20000	uS_cm
CHEMICALS	7	21	Max. chemical flowmeter impulse excess after switching off dosing pump	0	99	N_IMPULSES
CHAMBER	7	22	A0 temperature interval	0	99	DEGREE
CHAMBER	7	23	A0 temperature reference	0	99	DEGREE
CHAMBER	7	24	A0 lower temperature limit	0	99	DEGREE
PRINT OUT	7	25	Horizontal Resolution graphics (pixel/hour)	240	1000	NUM
REGENERAT.	7	26	Regeneration [memor. val./displayed val./no. cycles completed after being carried out] 1/10/never, 2/15/30, 3/20/25, 4/25/21, 5/30/18, 6/35/15, 7/40/12, 8/45/9, 9/50/6, 10/55/3, 11/60/1	1	11	N_TRANSCODE
REGENERAT.	7	27	Number of regenerations for salt load warning	1	18	NUM
KEYBOARD	7	28	Programme selected in position 1 (P1 key)	1	40	NUM
KEYBOARD	7	29	Programme selected in position 2 (P2 key)	1	40	NUM
KEYBOARD	7	30	Programme selected in position 3 (P3 key)	1	40	NUM
CHAMBER	7	31	Temperature difference respect the set-point ,for deactivating the chamber heating when set-point is below 90°C	P7.32	3	NUM
CHAMBER	7	32	Temperature difference respect the set-point ,for reactivating the chamber heating when set-point is below 90°C	0,1	P7.31	NUM

Sw version 7.04						
CATEGORY	SECTION	PARAMETER	DESCRIPTION	MIN	MAX	UDM
CHAMBER	7	33	Temperature difference respect the set-point ,for deactivating the chamber heating when set-point is over 90°C	P7.34	3	NUM
CHAMBER	7	34	Temperature difference respect the set-point ,for reactivating the chamber heating when set-point is over 90°C	0,1	P7.33	NUM
ÉQUIVALENCE						
CHEMICALS	8	5	Chemical product for dosing pump 1: impulse/millilitre (flowmeter)	0	9,999	IMP_mLT
CHEMICALS	8	7	Chemical product for dosing pump 3: impulse/millilitre (flowmeter)	0	9,999	IMP_mLT
CHEMICALS	8	9	Chemical product for dosing pump 1: sec/millilitre (timed control)	0	9,999	SEC_mLT
CHEMICALS	8	11	Chemical product for dosing pump 3: sec/millilitre (timed control)	0	9,999	SEC_mLT
CHEMICALS	8	13	Way of dosing for chemical product1 (0: by impulse, 1: timed)	0	1	MSG_DOSE_TYPE
CHEMICALS	8	15	Way of dosing for chemical product3 (0: by impulse, 1: timed)	0	1	MSG_DOSE_TYPE
CHEMICALS	8	17	Reference for automatic calibration of chemical flowmeter	1	999	milliLT

## 11.4 Details of the electronic card

The electronic card was designed for the control of the type of machine described below. Any use other than that specified above.

The electronic card was designed following the indications given in the standards below:

EN 60335	low voltage
EN 61000-6-3	emissions
EN 61000-6-1	immunity

## 11.5 Features of master card

### SERIAL INTERFACE

#### Com1:

Low voltage bus bar for two-way communication with the keyboard card.

#### Com2:

Asynchronous serial interface type RS 232 foreseen for connection to PC or printer.

## 11.6 Starting up and display of devices

It is possible to display the state of the devices.

Enter the menu: **UTILITY** → **MAINTENANCE** → **Insert 3<sup>rd</sup> level password** → **INPUT STATE**.

Push **P1** and **P2** buttons to scroll the list of input and push **START** button to enter.

Push **P1** and **P2** buttons to select the input to show.

Whether the entry is not active, the writing **OFF** appears, otherwise when active appears **ON**.

It is also possible to activate every device but the electrical resistance manually.

Enter the menu: **UTILITY** → **MAINTENANCE** → **Insert 3<sup>rd</sup> level password** → **OUTPUT STATE**.

Push **P1** and **P2** buttons to scroll the list of output and push **START** to select the contactor you want to activate.

Then push **P1** to activate it or **P2** to deactivate.

Nearby the display appears the contactor state.

Whether the contactor is not active, the writing **OFF** appears, otherwise when active appears **ON**.

If a contractor is not possible to activate you will see in the display "**FORBIDDEN**".

	<b>WARNING</b>
	<b>For input and output's specification see the wiring diagram.</b>

## 11.7 Password management

The programming access and the menu are protected by three password levels:

- **1<sup>st</sup> level:** *operator password* – allow the access to the programs selection, historical and USB menu access (view and printing, not historical deletion).
- **2<sup>nd</sup> level:** *technician password* – allow the access to all menu but with limited modification possibility.
- **3<sup>rd</sup> level:** *manufacturer password* – allow the complete access to all menu and settings of the machine.

The password is made up of from four characters. Every character can be chosen between:

- Number digits: from “0” to “9”;
- Uppercase alphabet: from “A” to “Z”;
- Lowercase alphabet: from “a” to “z”;
- Space “ ”;
- Minus sign “-”;
- Full stop “.”.

### 11.7.1 Password change

To set the password follow the procedure:

Enter the menu: **SETTING** → **PASSWORD** → **Insert 3<sup>rd</sup> level password (currently)**

Select the password that you want to change pressing **START** button.

During the insertion, the four characters are displayed with four stars \*\*\*\*. The selected character to be changed is flashing.

Pressing **P1** and **P2** buttons it is possible to set the value of character while pressing **START** button it is possible to confirm the selection and proceed with other character.

To confirm the insertion of new password press **START** button.

It will be required to insert new password: if the inserted password coincides with the one just set it will display the **MODIFY - DONE** - message otherwise, in case of incorrect insertion, it will display **ERROR** message.

In case of **ERROR** or exit from menu by pressing **STOP** button, the password will not be modified and remains valid the value in force.

	<p><b>ATTENTION</b></p> <p><b>In case of you forgot the password it is not possible to recover it. Contact the manufacturer that will provide a temporary password. This password only allows the access to password menu to set new password.</b></p>
---	--

### 11.7.2 Warning about unauthorized access

The alarm “**WARNING PASSWORD**” warns about any attempt to access at menu by unauthorized personnel.

It will displayed every time it is exceed the number of password entries set by parameter **P1.18** (**P 1.18=0** the alarm function is disabled).

To reset the alarm enter at password menu and insert the password.



# 12. CHEMICALS CALIBRATION

Chemical product have different viscosities, so it is recommended to calibrate the dosing system every time you change the type of chemical.

Depending on machine configuration and set parameter (P8.13 ÷ P8.17), the chemical dosing can be done by time or impulses (in this case **ONLY** if it present the flowmeter, ordered as **OPTIONAL**).

	ATTENTION
	<p>There is a risk of contact with the chemical product, therefore obtain appropriate individual protection gear (gloves for protection from chemical substances, breathing protection masks, goggles etc.) during the execution of operations.</p> <p>The chemical products are an irritant for the eyes, in case of contact rinse thoroughly with water and consult a doctor. If these products come into contact with the skin, rinse with plenty of water.</p>

## 12.1 Timed dosing

*In order to do the chemicals calibration it is necessary to control that the chemical products dosing system is completely filled.*

*For this calibration's procedure it is necessary to have the stopwatch.*

### 12.1.1 Calibration

Insert the suction lance of the chemical to be calibrated into a ml-graduated cylinder and fill it with the chemical up to 250 ml.

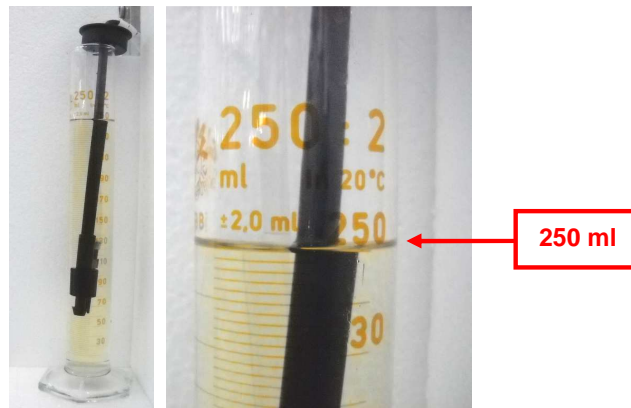

*Chemical product*

To start the calibration of dosing system it is necessary to activate manually the dosing device.

Enter the menu: **UTILITY** → **MAINTENANCE** → **Insert 3<sup>rd</sup> level password** → **OUTPUT STATE**

Push **P1** and **P2** buttons to scroll the list of devices and push **START** button to select the desired device.

After selecting the device to calibrate (see the input/output section 11.6) push **P1** button to activated the device and at same time activate the stopwatch to start measuring the time of dosing.

Push **P2** button to deactivate the device when the level of chemical product in ml-graduated cylinder have reached 100 ml and stop the stopwatch.



*Chemical product*

Calculate the value of calibration as the ratio between the time measured by the stopwatch and the amount of chemical product dosed in the cylinder (Ex. 45 sec / 100 ml = 0.45).  
Insert the previously calculated value in the relative parameter relative of the doser on the section "EQUIVALENCE".

### 12.1.2 Check

After the calibration it is necessary to control the calibration efficacy by the check procedure:

- Activate manually the dosing device and the stopwatch to start measuring the time.
- When the stopwatch reaches the dosing time measured in the previous calibration procedure deactivate the dosing device.
- Check that the level of product in the ml-graduated cylinder is 100 ml or the same dosed in the previous calibration procedure.
- If the level of dosed product is correct the check procedure is finished and continue the chemical calibration for others dosing devices.
- If not calculate the new value of the equivalence taking into account the dosage values previously calculated and the amount of chemical dosed.

Example:

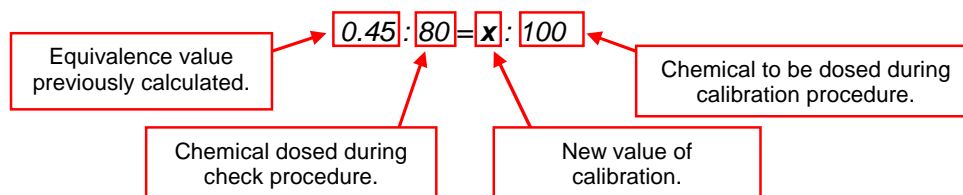

- Insert the new value in the related parameter of the doser on the section "EQUIVALENCE".
- Control the calibration consistency with a new check procedure.

**AFTER THE CHEMICAL CALIBRATION IT IS NECESSARY TO RUN A RINSING CYCLE WITHOUT INSTRUMENTS INSIDE THE CHAMBER.**

## 12.2 Impulsed dosing

In order to set the flowmeters it is necessary to control that the chemical products dosing system is completely filled.

### 12.2.1 Calibration

Enter the menu: **SETTINGS** → **FLOWMETERS** → Insert 2<sup>nd</sup> level password → **CALIBRATION**

Select the flowmeter that you want to calibrate by using **P1** and **P2** buttons.

**ATTENTION:** If it is not present the flowmeter the system displays the message “**FORBIDDEN**”.

Insert the suction lance of the chemical to be calibrated into a ml-graduated cylinder and fill it with the chemical up to 250 ml.



Chemical product

After selecting the flowmeter to calibrate (see the input output section 11.6) push **START** to start the procedure and **CONFIRM** it.

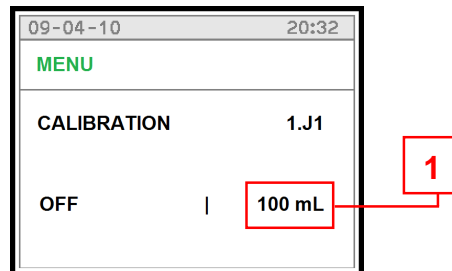

Press **START** when the level on the ml-graduated cylinder have reached the displayed quantity (1). If you want to shut off the procedure press **STOP**.

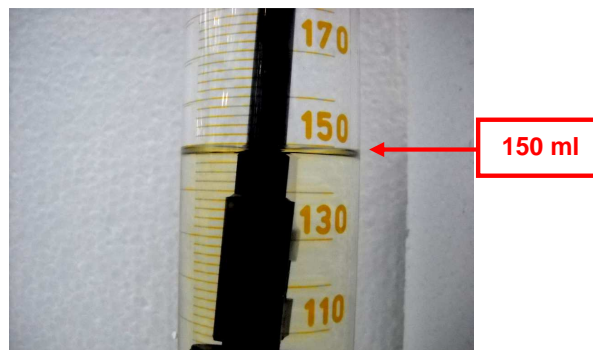

Chemical product

### 12.2.2 Check

After the calibration it is necessary to control the calibration efficacy by the CHECK procedure.

Enter the menu: **SETTINGS** → **FLOWMETERS** → **Insert 2<sup>nd</sup> level password** → **CHECK**

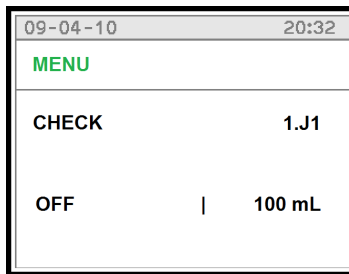

Select the chemical flowmeter to check and press **START** to begin the calibration verification.

Once finished the dosing, the level of product in the ml-graduated cylinder should be the same of that one shown in the display.

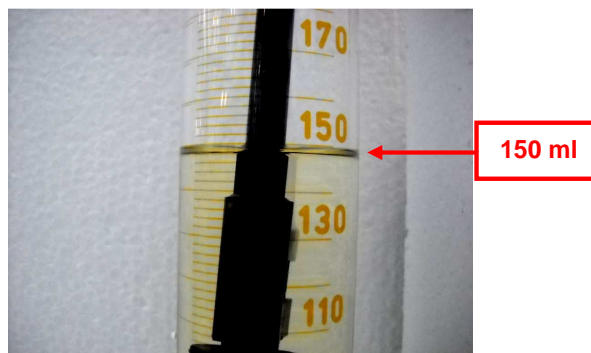

*Chemical product*

Whether the levels do not correspond, a new calibration must be executed.

The quantity of product to execute the calibration can be changed using 8.17 parameter.

**AFTER THE CHEMICAL CALIBRATION IT IS NECESSARY TO RUN A RINSING CYCLE WITHOUT INSTRUMENTS INSIDE THE CHAMBER.**

## 13. CLOCK

- The card has a real-time clock.
- Time readings are also used when recording historical data.

## 14. HISTORICAL DATA

During the working cycle, the machine memorizes on a card all the working data of the wash cycles that have been performed.

- The card is able to record the fields described below for up to a max. of 200 cycles in the permanent memory. The fields given in the example below are recorded for each cycle:

DATE	START TIME	PROGRAMME	MAX °C	HOLD>85°C	FAULTS
12/12/2012	12.00	Short	93°C	60 seconds	01
12/12/2012	13.05	Standard	94°C	180 seconds	01

- When 95% of the memory is full the dump memory message appears on the display. To clear the message, insert the USB key on the dedicated port and enter the menu. Select the USB menu and download from the machine the historical data.
- The various causes for machine shutdowns are indicated in the FAULTS section, identified by alarm code.

# 15. ALARMS and EVENTS LIST

## 15.1 Logical description of alarm interventions

During machine operation, the operator is aided by **ALARMS** or **WARNING** which make use of visual signals on the operator display panel to advise him of possible anomalies in progress and machine alarms which have intervened.

Intervention of an **ALARM** during operation of the system is signalled to the operator by a message on the operator panel.

The alarm which appears on the panel remains active until the cause of intervention is removed.  
The intervention of an alarm stops the wash cycle currently in progress.

## 15.2 List of alarm messages

Possible alarms which may intervene during a work cycle are shown on the control panel display.  
The message includes the number of the alarm that has intervened and its name.  
A complete list of possible alarm messages follows.

ALARM	DISPLAY MESSAGE	DESCRIPTION
1	<b>power failure</b>	It signals power failure during cycle.
2	<b>open load. door</b>	Loading door open and/or unlocked during cycle.
3	<b>open unload.door</b>	Unloading door open and/or unlocked during cycle.
4	<b>load.door fail.</b>	Loading door blocked but open (discrepancy).
5	<b>unload.door fail</b>	Unloading door blocked but open (discrepancy).
6	<b>doors problem</b>	Incorrect door position ( both open or unblocked).
7	<b>unblock.door 1</b>	Loading door problems: a) Overtime lock door ref. P6.14. b) During block door, the door has been opened.
8	<b>unblock.door 2</b>	Loading door problems: c) Overtime lock door ref. P6.14. d) During block door, the door has been opened.
9	<b>unlocking 1fail.</b>	Overtime unlock loading door ref. P6.13.
10	<b>unlocking 2fail.</b>	Overtime unlock unloading door ref. P6.13.
11	<b>no cold water</b>	Overtime cold water filling level ref. P6.05 or overtime cold water impulse reading from flowmeter ref. P6.11.
13	<b>no demin. water</b>	Overtime demi water filling level ref. P6.07 or overtime warm water impulse reading from flowmeter ref. P6.11.
15	<b>no c.+demi water</b>	Overtime cold+demi water filling level ref. P6.09.
17	<b>no chemical 1</b>	Lack of chemical 1 (if enabled with alarm on P3.06).
18	<b>no chemical 2</b>	Lack of chemical 2 (if enabled with alarm on P3.06).
19	<b>no chemical 3</b>	Lack of chemical 4 (if enabled with alarm on P3.06).
20	<b>no chemical 4</b>	Lack of chemical 3 (if enabled with alarm on P3.06).
23	<b>drain timeout</b>	Overtime minimum tank level during the drain: Ref . P6.03 and P6.04.
24	<b>fan problem</b>	Blower switch on with pressure switch open.
25	<b>drying min°C</b>	During the dryer the air temperature is not arrive at the temperature set at parameter P7.13, otherwise the temperature is under the set point if the set point is lower than parameter P7.13.
26	<b>prewash max°C</b>	Tank temperature over maximum setup during prewashing.
27	<b>tank probe lim°C</b>	Tank temperature over maximum value 102°C.
28	<b>dryingprobelim°C</b>	Dryer temperature over maximum value 162°C.
30	<b>tank probe</b>	Tank temperature 1 <sup>st</sup> probe failure.
31	<b>tank probe 2</b>	Tank temperature 2 <sup>nd</sup> probe failure.
32	<b>drying probe</b>	Dryer temperature probe failure.

34	check temp.	It appears when: a) Tank temperature over value ref. P7.12. b) The temperature between the two probes has a difference higher than 1°C ref. P7.11. c) Tank heating element off. d) All the condition a,b,c) still exist form 30 s.
35	Serial connect.1	No connection from master PCB to loading control panel PCB.
36	Serial connect.2	No serial connection between expansion board to the keyboard (unloading side).
37	CANserialconnec.	No connection from master to slave PCB (can bus).
39	no tank heating	During tank heating phase, the temperature does not increase of 1°C into the prefixed time given by parameter P6.01.
46	pump	Washing pump switch on with pressure switch closed. The washing pump is incorrect turning.
47	flowmeter fail.1	The flowmeter product 1 had counted an impulses number superior to the threshold value set by parameter P7.21 with pump switched off.
48	flowmeter fail.2	The flowmeter product 2 had counted an impulses number superior to the threshold value set by parameter P7.21 with pump switched off.
49	flowmeter fail.3	The flowmeter product 3 had counted an impulses number superior to the threshold value set by parameter P7.21 with pump switched off.
50	flowmeter fail.4	The flowmeter product 4 had counted an impulses number superior to the threshold value set by parameter P7.21 with pump switched off.
55	conduc. probe	Conductivity probe failure.
56	conductivity	For 3 consecutive times high conductivity.
58	no tank heating	During steam tank heating phase, the temperature does not increase of 1°C into the prefixed time given by parameter P6.01.
60	Time	In the treatment phase, the thermal control time limit has expired (30 minutes), with counting started the first time that the tank temperature reaches +0.5 °C (with water filling complete and any gradual cooling of the chamber concluded). Signals the undefined permanence situation in the phase for the following possible causes: - Temperature oscillations above/below the set point due to structural defects of the flue; - Error in setting the insertion temperature of a chemical (> thermal control set point).

## WARNINGS LIST

DISPLAY	DESCRIPTION
<b>press start</b>	It is possible to start a cycle during a stand-by state. With a double door machine is necessary to open and close the door one time after the end of a cycle.
<b>no chemical 1</b>	The chemical product associated to dosing pump 1 is used-up (if it is set as a warning by P3.06). Diagnostics with dosing pump enabled: - Pressure switch state with pressure switch presence; Lack of a new impulse after the time set by P6.12 if a flowmeter is used.
<b>no chemical 2</b>	The chemical product associated to dosing pump 2 is used-up (if it is set as a warning by P3.06). Diagnostics with dosing pump enabled: - Pressure switch state with pressure switch presence; Lack of a new impulse after the time set by P6.12 if a flowmeter is used.
<b>no chemical 4</b>	The chemical product associated to dosing pump 4 is used-up (if it is set as a warning by P3.06). Diagnostics with dosing pump enabled: - Pressure switch state with pressure switch presence; Lack of a new impulse after the time set by P6.12 if a flowmeter is used.
<b>no chemical 3</b>	The chemical product associated to dosing pump 3 is used-up (if it is set as a warning by P3.06). Diagnostics with dosing pump enabled: - Pressure switch state with pressure switch presence; Lack of a new impulse after the time set by P6.12 if a flowmeter is used.
<b>salt loading</b>	Make a salt refill after the cycle number set by P7.27 (with P7.26 different form 10).
<b>- open door -</b>	Inform that one door is open.
<b>WAIT</b>	Generic warn that inform to wait before to do a new action.
<b>close door!</b>	It warns to close the door/doors opened during the doors initialisation procedure in order to allow the correct procedure.
<b>ON PRINT</b>	It appears when you try to start a cycle through the start button during the phase of graph printing.
<b>NO DISINFECTION</b>	The procedure of the end cycle after the manual stop of cycle on working through button that interrupted a cycle is finished and the machine is waiting the manual unlocking opening of the door and/or opening unlocking door.

## HISTORICAL EVENTS

EVENT	DISPLAY MESSAGE	DESCRIPTION
<b>FROM 1 TO 60</b>	<b>SAME LIST OF ALARMS</b>	(SEE ALARMS LIST)
<b>90</b>	<b>OK</b>	CYCLE ENDS WITH SUCCESS
<b>91</b>	<b>NO DISINFECTION</b>	CYCLE HAS BEEN INTERRUPTED

## 16. PC INTERFACE

The card has a communication channel RS 232 with Modbus protocol.

The channel can be used to access the historical data records file by setting the printer as follows:

- **baud rate: 9600 baud, X ON X OFF**
- **data bits: 8bits,**
- **parity: none.**



## 17. USB PORT

On the control panel board there is an USB port that allows the machine programming and data saving.



### 17.1.1 Programming

It is sufficient to insert the USB key on the port and switch OFF and switch ON the control panel board using the ON/OFF button.

The display will ask about the new files installation allowing the selection between APPEND (add only the new parts) and OVERWRITE (delete the existing files and install the new one).

It is possible to program:

- Parameters
- Cycles
- Control panel FW
- Language file

### 17.1.2 Data saving

Insert the USB key on the dedicated port and enter the menu and select the USB menu; it is possible to download from the machine the following information and files:

- cycles
- parameters
- historical
- maintenance historical

***The cycle and parameter files can be used to program another machine or as back-up of the machine.***

### 17.1.3 Data saving during the cycle

To save the data at the end of every washing program, insert the USB key on the dedicated port and follow the procedure:

Set the parameters P1.04 at 3 and P1.05 to YES.

Start the washing program.

At the end of the cycle the machine creates the file with the samples of temperature and pressure probes with the information of every washing program phases.

To every washing program are associated two files which contain the data structured as below.



The file \*\*\*\*\*G.TXT contains:

**N.B.: the \*\*\*\*\*G.TXT will be saved in automatically at the end of the washing program.**

```

*****
*****
End user      : *****
Model        :
Machine      : 13146
Work station  : 0
Software     : 7.00
Operator     :
-----
B20 PREWASH  Record: 00015
.....
START:      05/06/13   h: 16:10
-----
n°           mm:ss      °C(1) °C(2) Bar
0001        0:00        35.2  35.1  ----
0002        0:05        35.2  35.1  ----
0003        0:10        35.2  35.1  ----
0004        0:15        35.2  35.1  ----
0005        0:20        35.2  35.1  ----
0006        0:25        35.1  35.0  ----
-----
WRITE OK
-----
    
```

Annotations:

- Information related to machine and operator. (points to the first section)
- Information related to washing program. (points to the second section)
- Number of samples. (points to the 'n°' column)
- Sampling time. (points to the 'mm:ss' column)
- Data value to sampled data. (points to the temperature and bar columns)



The file \*\*\*\*\*C.TXT contains:

**N.B.: To save the \*\*\*\*\*C.TXT, insert the key in the dedicated port, enter the menu, select the USB menu and download from the machine the information of historical.**

```

*****
*****
End user      : *****
Model        :
Machine      : 13146
Work station  : 0
Software     : 7.00
Operator     :
-----
B20 PREWASH  Record: 00015
.....
START:      05/06/13   h: 16:10
-----
-> chemical load      h: 16:10
   T1= 35.2°C T2= 35.1°C
-> 1: drain           h: 16:11
   T1= 35.1°C T2= 35.0°C
-> 2: prewashing      h: 16:16
   T1= 24.5°C T2= 24.5°C
-> 3: drain           h: 16:17
   T1= 24.6°C T2= 24.6°C
STOP:          05/06/13   h: 16:17
END CYCLE: OK
    
```

Annotations:

- Information related to machine and operator. (points to the first section)
- Information related to washing program. (points to the second section)
- Information related to every washing program phase. (points to the third section)

### 17.1.4 Operator archive management

It is possible to save the archive operators present inside of machine memory into a file following the procedure:

Insert the USB key into dedicated port.

Enter menu: **USB** → **OPERATOR** → Insert 3<sup>rd</sup> level password → **USB EXPORT** → Press **START** button.

The name of file is “**OPERATxxxx.CSV**”, where “**xxxx**” stands for an optional generic denomination and it contains the data structured as below:

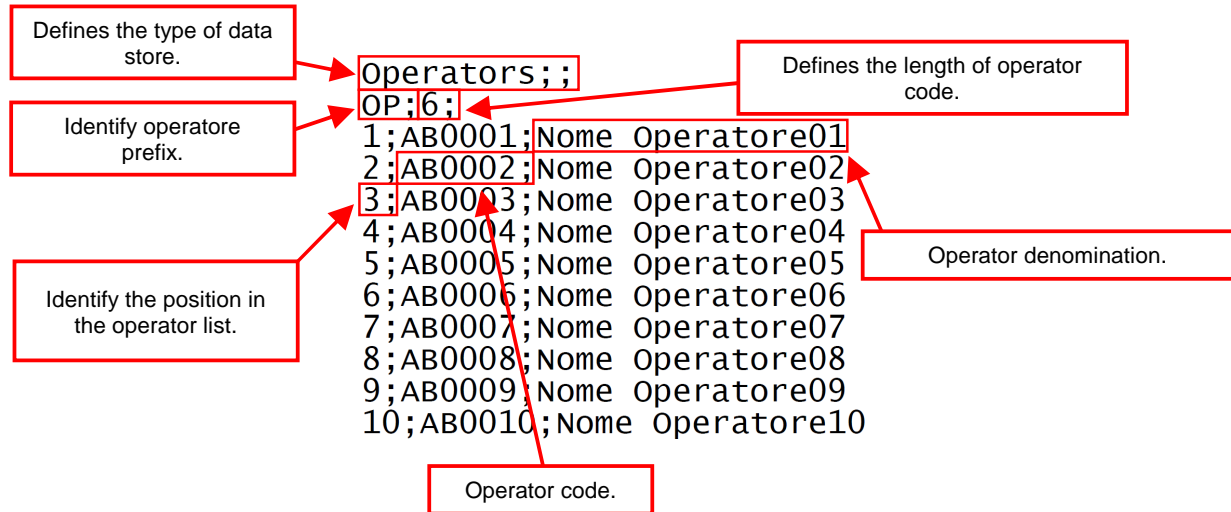

FIELD	FIXED CHARACTERISTICS
Type of data store	Nothing
Operator prefix	Length = 2 Allowable characters: 0...9 number digits, "A...Z" uppercase alphabet, "a..z" lowercase alphabet, " " space, "-" minus sign, "." full stop.
Length of operator code	From 1 to 8
Position in the operator list	Progressive order (Maximum number of operators = 60)
Operator code	Allowable characters: 0...9 number digits, "A...Z" uppercase alphabet, "a..z" lowercase alphabet, " " space, "-" minus sign, "." full stop.
Operator denomination	Length ≤ 16 (can be empty) Allowable characters: 0...9 number digits, "A...Z" uppercase alphabet, "a..z" lowercase alphabet, " " space, "-" minus sign, "." full stop.

It is possible to upload the archive operators by insert the USB key into dedicated port and enter the menu: **USB** → **OPERATOR** → Insert 3<sup>rd</sup> level password → **USB IMPORT** → Press **START** button.

	<b>ATTENTION</b>
	<ul style="list-style-type: none"> <li>To modify the operator archive file it is recommended use a text editor (ex. Notepad).</li> <li>If the file contains an operator with the field “<b>OPERATOR CODE</b>” null (no character), the file is considered valid up to the previous operator. All subsequent element are ignored.</li> <li>If the file contains values that do not comply with the constraints described above, the file is considered incorrect. During the upload it is displayed the first line where the error is present.</li> </ul>

# 18. MAINTENANCE

## 18.1 General recommendations on maintenance

The machine was constructed only for washing and thermal disinfection of orthodontic instruments, trays and objects normally used in orthodontic studios, hospital wards, assisted living centres, and so forth.

It is therefore subject to constant contact with aggressive detergents and with contaminated instruments.

For this reason it is necessary to provide some useful instructions for the operators who will be performing maintenance on it.

**The maintenance technicians**, in normal operating conditions, are not subject to risks if they work safely using suitable means of protection.

In order to work safely the maintenance technician must:

- Carefully comply with the instructions set forth in this manual.
- Use safety devices appropriately and with care, as well as group and individual safety gear provided in the workplace.
- Use special care in making repairs or replacing mechanical parts (e.g. drain pump, etc.) on malfunctioning machines which have not completed the thermal disinfection cycle.

Maintenance operations for the machine described in this manual can be divided into "**Routine Maintenance**" and "**Special Maintenance**".

### GENERAL GUIDELINES

#### **MACHINE STATUS:**

The machine must not be powered electrically and the dedicated safety device must be in the OFF position. Person performing the task must ensure that there is no-one around the machine during this operation.

#### **SAFETY SYSTEMS TO BE ADOPTED:**

The operation must be carried out in compliance with standards governing the use of disinfectant substances used (see technical information for the product being used), in compliance with standards concerning contact with parts of the machine which may be contaminated by pathogenic materials and with use of individual protection gear.

### 18.1.1 Maintenance request

The machine displays the "**MAINTENANCE**" warning after a specified time or after a specified numbers of working hour according to parameter **P6.48**. This warning doesn't affect the normal use of machine.

The service technician must do the maintenance operations in the shortest possible time.

To clear the "**MAINTENANCE**" warning, follow the procedure:

1. Do the general maintenance of machine;
2. Enter at the MENU':

**UTILITY → MAINTENANCE → Insert 3<sup>rd</sup> level passord → MAINTENANCE REGISTER → Press START button.**

## 18.2 Procedure for routine maintenance work

Routine maintenance includes all operations aimed at keeping various parts of the machine clean and functional.

They must be performed on a regular basis (see table in paragraph 18.3) or when considered necessary due to incorrect performance of washing cycle.

Since these are simple cleaning operations, they are normally performed by the machine operator on his own liability.

## 18.3 Table of routine maintenance tasks

The following table shows the various routine maintenance tasks, their frequency, who is to perform them and the reference to the specific intervention form.

Each single task is more fully explained in the single reference forms.

Even if the water supply is relatively soft, the high temperature can cause the formation of residues which may create problems with the heating element, compromising the correct wash cycle and the reaching of the disinfection temperature.

For these reasons it is advisable to carry out regular cleaning as described below.

## TABLE OF ROUTINE MAINTENANCE TASKS

<b>EUROSAFE 60 D</b>													WORKER	TIME	REFERENCE		
Programmed maintenance scheme																	
Components	Step	months															
		3	6	9	12	15	18	24	Activity								
Chamber filters	make every.....													Take off filters and cleaning.	AC	10'	M1
Water solenoid filter	make every day													Check, clean and if necessary replace.	IS	10'	M4
Dryer pre-filter (if present)	make every 100 hours		X											Replace.	IS	2'	M5
Dryer HEPA filter (if present)	make every 300 hours													Replace.	IS	2'	M5
Temperature probes	make every.....		X											During periodic validation, check the sensor status.	IS	60'	M2
Safety thermostat	make every.....		X											Verify the sensor.	IS	5'	M2
Chemical flowmeters (if present)	make every.....		X											Open the flowmeter and clean the inner side. If it stays inactive for more than 15 days, make and inner cleaning before using.	IS	10'	
Chemical dosing pump	make every.....		X											Check the membrane pipe and the presence of lack.	IS	5'	M6
Inner pipe and connection pipe of dosing pump	make every.....		X											Replace.	IS	12'	M6
Chemical tank level sensor	make every.....		X											Check and clean the suction filter.	IS	4'	
Connection pipe of dosing pump	make every.....		X											Check of crashing, any lacks or hardening.	IS	10'	
Washing arms	every week													Check for free rotation. Open the cleaning caps and wash inside; check and in case cleaning the nozzle. Verify the gasket.	AC	30'	M3
Door gasket	make every.....		X											Replace after 1000 cycles.	AC	5'	
Washing pumps	make every...				X									Check for water leaks from the arm seal.	IS	20'	
Water heating element	make every...						X							Check for water leaks from the gasket.	IS	5'	
Water solenoid valves	make every...							X						Check for any leaks, if necessary remove and clean the membrane seat.	IS	1'	
Drain pump	make every...								X					Check for any leaks, if necessary remove and clean the membrane seat.	IS	3'	
Pressure switches	make every...									X				Operation is checked by the control system. In case of defect of control system of water levels, go on by emptying the tank, blowing inside the black pipe connected to the pressure switch, in order to free from obstructions.	IS	10'	
Pipe of unloading water	make every...										X			Check the situation of pipe and the seal.	IS	3'	
Pipes of loading water	make every...											X		Check the situation of pipe and the seal.	IS	3'	

**Is** = Installation and repair technician - **As** = Responsible authority for the machine in the workplace - **Ac** = Machine operator

**N.B.:**

Routine maintenance tasks must be performed at the intervals set forth in the table.  
It is however advisable to carry out single cleaning tasks anytime you feel they may be necessary.

In case the machine requires the replacement of one or more components, please refer to the manufacturer's spare part list.	
	It is advisable to carry out a general check-up and to clean the appliance regularly, particularly if the supply water is very hard.
	Particular attention should be paid to heating element and the probe of thermostats.

### WARNING

- Do not clean the machine outside with high pressure water.
- Please contact the retailer that supplies your cleaning products for details of recommended methods and products for sanitizing the machine regularly.
- The machine has a safety thermostat that shuts down the power supply to the heating elements in the event of overheating.  
Before turning the machine back on, you will need to eliminate the problem and wait for the temperature to drop back below operating levels.

**To re-start the appliance the fault that caused overheating must be corrected.**

### Every 12 months

- Clean the diaphragms of solenoid valves and replace if necessary;
- Clean the thermostat probe.
- Change the membrane pipe inside dosing pump.

Even if the supply water is soft, the high working temperatures may cause limescale to build-up. Apart from damaging the resistors, limescale can also clog the nozzles in which case the correct tank temperature for thermodisinfection may not be reached.

### WARNING

**IT IS NECESSARY TO MAKE A MAINTENANCE AT REGULAR INTERVALS, THIS MEANS EVERY 3 MONTHS, IN ORDER TO GUARANTEE THE PERFECT FUNCTIONING OF DOSING PUMPS OF CHEMICAL PRODUCTS.**

CLEANING OF WASHING CHAMBER DRAIN FILTERS		
<b>M1</b>	Worker: <b>Ac</b>	Frequency of Intervention: <b>every day</b>
<b>METHOD OF INTERVENTION:</b> clean the washing chamber drain filters in the following manner:		
<ul style="list-style-type: none"> <li>• Open the washing chamber door and extract the basket.</li> <li>• Extract the drain water filtering assembly from the chamber.</li> </ul>		
<ul style="list-style-type: none"> <li>• Unscrew the threaded pin and remove the cover of the drain water filter basket.</li> </ul>		



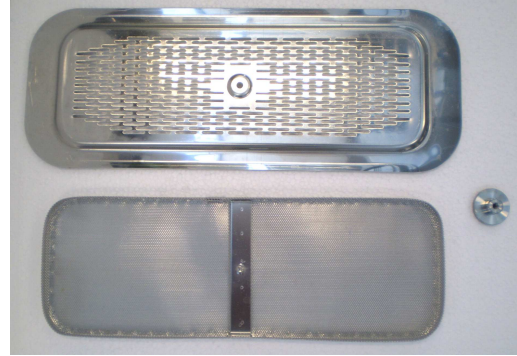
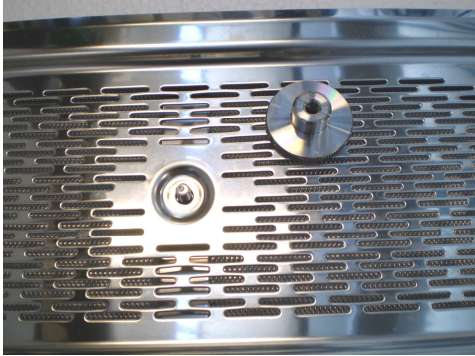
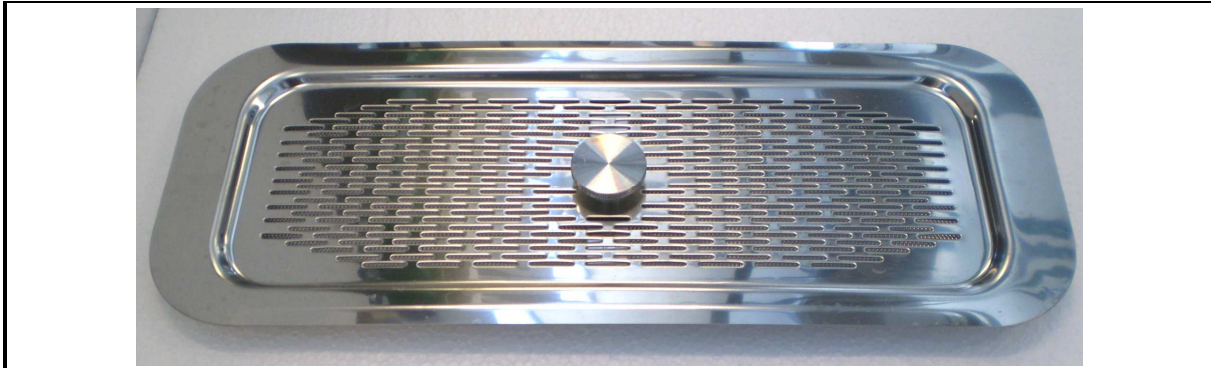

- Clean the drain water filter basket. Remove residues deposited during various washing cycles.
- Remove and clean any deposits and incrustations from the washing chamber drain.



- Replace the clean filter on the washing chamber drain.
- Put the cover for the drain water filter back in place. Lock it in position with the threaded pin.
- Put the drain water filter group back in the wash chamber.

**CLEANING OF WASHING CHAMBER THERMOSTAT PROBE**

**M2**    Worker: **Is**    Frequency of Intervention: **6 months**

**METHOD OF INTERVENTION:** clean the washing chamber thermostat probe in the following manner:

- Open the washing chamber door and extract the basket.
- Check the washing chamber thermostat probe and clean it of any deposits or lime incrustations using a damp cloth and an appropriate detergent.

**Take care not to damage or move the probe.**

## CLEANING OF WASHING ROTORS

**M3**

Worker: **Ac**

Frequency of Intervention: **every week**

**METHOD OF INTERVENTION:** clean the washing rotors as follows:

- Open the washing chamber door and extract the basket.
- Unscrew the fastening pin of the two rotors and extract them from the chamber.



- Unscrew the closure plug of the rear part of the nozzle and remove it.



- Carefully cleaned and remove any incrustations from the washing rotor nozzles using appropriate detergents.
- Put the plugs back in place at the ends of the washing arms.  
Make sure the gasket is properly positioned and in good condition.  
Replace it if necessary.
- Put the rotors back on the machine.
- Lock them in place with the previously removed fastening pin.



<b>CLEANING AND CHECKING WASH CHAMBER INSTRUMENTATION</b>						
	Worker: <b>Ac</b> Frequency of Intervention: <b>Once a week or when it is necessary</b>					
<b>METHOD OF INTERVENTION:</b>						
Carry out an empty washing cycle with a basket present so as to carry out the disinfection process inside the washing chamber. This will guarantee a complete disinfection of the washing chamber, the basket and the hydraulic circuits.						
In case it is not possible to carry out an empty washing cycle, it is advisable to proceed with the disinfection of the machine as described below:						
<ul style="list-style-type: none"> <li>• Open the access door to the chamber and check that no equipment, trays, or instruments have been left on the washing basket.</li> <li>• Inside the washing chamber, evenly spray a disinfectant that is both compatible to be used on stainless steel surfaces</li> </ul>						
	<table border="1"> <thead> <tr> <th style="text-align: center;"><b>ATTENTION</b></th> </tr> </thead> <tbody> <tr> <td>As regards the contact time and the methods of use of the disinfectant used, please comply with the instructions given on the technical data sheet of the product itself.</td> </tr> <tr> <td>Always check the compatibility of the chemical product with the materials it will be used on; this information can be found on the technical data sheet of the chemical product used.</td> </tr> <tr> <td>The application of the disinfectant inside the chamber must be carried out when the surfaces are cold in order to avoid harmful fumes coming from the product being inhaled.</td> </tr> <tr> <td>It is advisable to contact your cleaning products dealer to obtain detailed instructions relating to the periodic disinfection of the machine.</td> </tr> </tbody> </table>	<b>ATTENTION</b>	As regards the contact time and the methods of use of the disinfectant used, please comply with the instructions given on the technical data sheet of the product itself.	Always check the compatibility of the chemical product with the materials it will be used on; this information can be found on the technical data sheet of the chemical product used.	The application of the disinfectant inside the chamber must be carried out when the surfaces are cold in order to avoid harmful fumes coming from the product being inhaled.	It is advisable to contact your cleaning products dealer to obtain detailed instructions relating to the periodic disinfection of the machine.
<b>ATTENTION</b>						
As regards the contact time and the methods of use of the disinfectant used, please comply with the instructions given on the technical data sheet of the product itself.						
Always check the compatibility of the chemical product with the materials it will be used on; this information can be found on the technical data sheet of the chemical product used.						
The application of the disinfectant inside the chamber must be carried out when the surfaces are cold in order to avoid harmful fumes coming from the product being inhaled.						
It is advisable to contact your cleaning products dealer to obtain detailed instructions relating to the periodic disinfection of the machine.						

<b>CLEANING THE EXTERNAL BODY OF THE MACHINE</b>	
	Worker: <b>Ac</b> Frequency of Intervention: <b>every day</b>
<b>METHOD OF CLEANING OUTER BODY</b>	
Use a damp cloth to clean the outer body of the machine. Use only neutral detergents. Do not use abrasive detergents or solvents and/or thinners of any kind.	
<b>METHOD OF CLEANING MARKING LABEL</b>	
Use a damp cloth to clean the marking label surface. Use only water or isopropyl alcohol. Do not use abrasive detergents or solvents and/or thinners of any kind.	
<b>METHOD OF CLEANING CONTROL PANEL</b>	
Clean the control panel using only a soft cloth dampened with a product for the cleaning of plastic materials.	

<b>LIMESCALE REMOVAL TREATMENT</b>			
	Worker: <b>Ac</b> Frequency of Intervention: <b>whenever necessary</b>		
<b>METHOD OF INTERVENTION:</b>			
Use a descaling agent (we recommend vinegar) during an empty washing cycle with cold water (this is usually carried out every week unless the quality of the water requires a daily treatment in order to prevent the build-up of limescale and the blockage of the water jets).			
As regards the quantity of the product to use, please comply with the instructions given on the technical data sheet of the product itself. In case vinegar is used, use 0.5 litres.			
The descaling product must be poured into a container of the same size, positioned on an empty loading basket.			
Use a washing programme with water at room temperature, without activating the drying cycle.			
	<table border="1"> <thead> <tr> <th style="text-align: center;"><b>ATTENTION</b></th> </tr> </thead> <tbody> <tr> <td><b>Even if the feed water only contains a small amount of limescale, high temperatures can generate the formation of limescale residues. This, as well as problems that could be caused to the heating element, may cause the blockage of the nozzles, jeopardising the correct washing process and preventing the ideal disinfection temperature in the tank to be reached.</b></td> </tr> </tbody> </table>	<b>ATTENTION</b>	<b>Even if the feed water only contains a small amount of limescale, high temperatures can generate the formation of limescale residues. This, as well as problems that could be caused to the heating element, may cause the blockage of the nozzles, jeopardising the correct washing process and preventing the ideal disinfection temperature in the tank to be reached.</b>
<b>ATTENTION</b>			
<b>Even if the feed water only contains a small amount of limescale, high temperatures can generate the formation of limescale residues. This, as well as problems that could be caused to the heating element, may cause the blockage of the nozzles, jeopardising the correct washing process and preventing the ideal disinfection temperature in the tank to be reached.</b>			

## 18.4 Procedure for special maintenance work





All special maintenance work is to be performed only by qualified, skilled personnel.

A table is shown below which includes possible special maintenance work that may be required. If your machine should require special maintenance, please contact your retailer/distributor.

## 18.5 Table of special maintenance tasks

See scheduled maintenance form table.

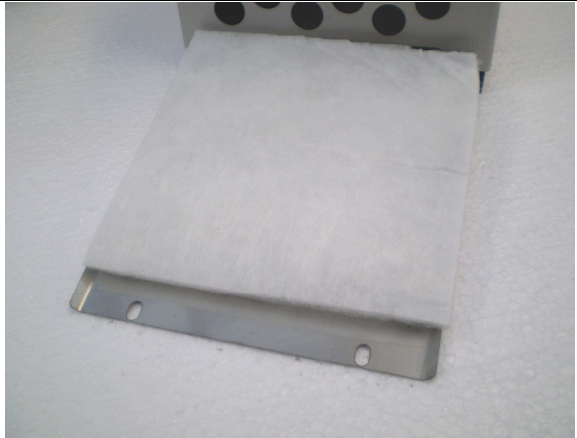
CLEANING OF COLD WATER INLET FILTERS		
<b>M4</b>	Worker: <b>Is</b>	Frequency of Intervention: <b>6 months or when necessary</b>
<b>METHOD OF INTERVENTION:</b> clean (or replace) the filter on the cold water supply tube as described below:		
<ul style="list-style-type: none"> <li>• Close the water supply tap.</li> <li>• Loosen and completely unscrew the water supply pipe.</li> <li>• Remove the filter located inside the water supply pipe fitting and clean it, removing any incrustation or deposits by immersing it in a container of water, or in appropriate lime removal products if required.</li> </ul>		

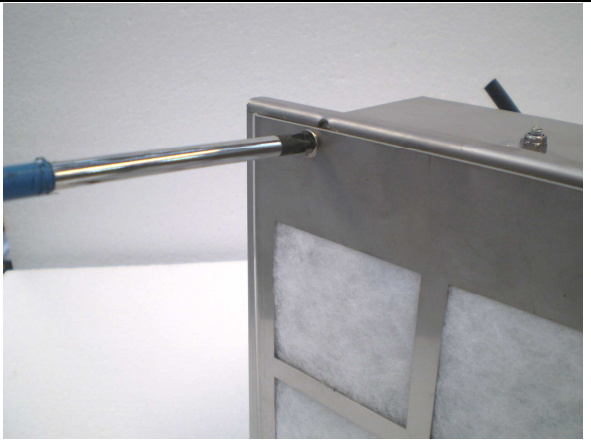
CLEANING OF DRYING SYSTEM PRE-FILTER (IF PRESENT)		
<b>M5</b>	Worker: <b>Is</b>	Frequency of Intervention: <b>100 hours</b>
<b>METHOD OF INTERVENTION:</b> clean (or replace) the drying system filter as described below:		
<ul style="list-style-type: none"> <li>Remove the two screws from the drying system filter protective front panel and remove it from the machine.</li> </ul>		
		
<ul style="list-style-type: none"> <li>Extract the filter and clean it of any dust. If the filter is no longer usable, replace it with another filter of the same type.</li> </ul>		
		
<ul style="list-style-type: none"> <li>Carefully put the clean (or new) filter back in place. Use the screws to fasten the previously removed protective front panel.</li> </ul>		
		



**CLEANING OF DRYING HEPA FILTER (IF PRESENT)**

**M5** Worker: **Is** Frequency of Intervention: **300 hours**

**METHOD OF INTERVENTION:** clean (or replace) the drying system filter as described below:

- Remove the two screws from the drying system filter protective front panel and remove it from the machine.



- Extract the pre-filter and than the HEPA filter: replace it with another filter of the same type.

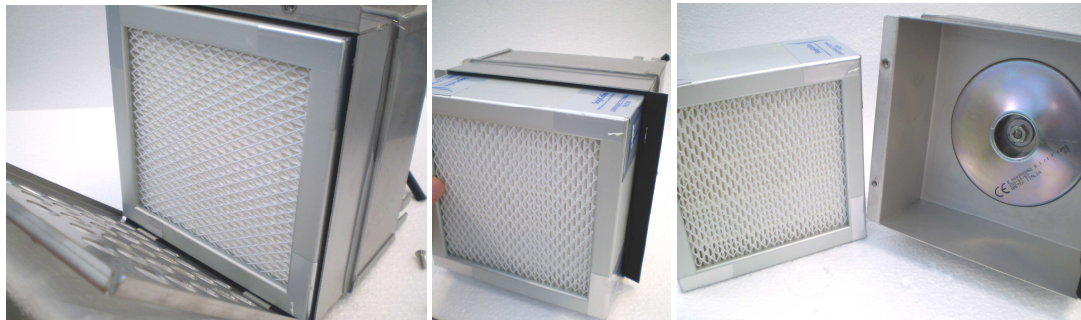

- Carefully put the pre-filter back in place. Use the screws to fasten the previously removed protective front panel.

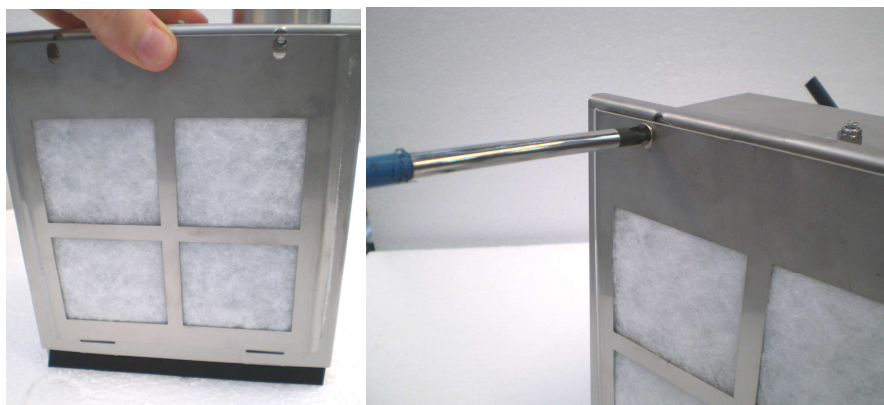

**REPLACEMENT THE MEMBRANE PIPE OF DISPENSING PUMP**

**M6** Worker: **Is** Frequency of Intervention: **from 3 to 6 months**

**METHOD OF INTERVENTION:** replace the membrane pipe of dispensing pump for chemical products as described below:

1. Remove the closure panel of the machine by removing the screws.
2. Access the chemical product pump. Use a tool to remove the protective mask of the rotor.

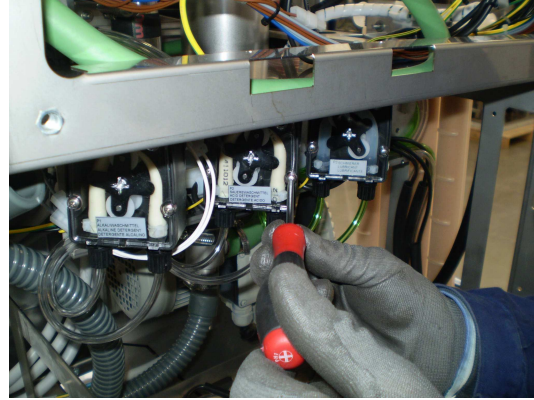
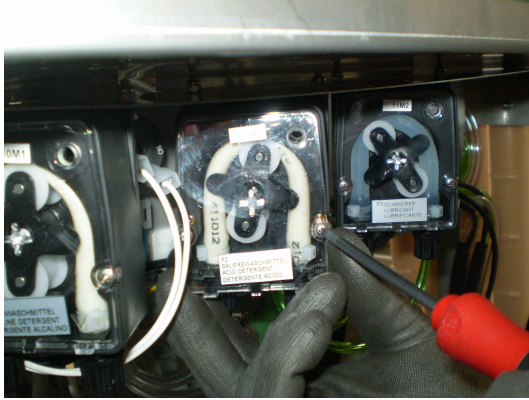

3. Extract the membrane pipe from the dispensing pump.
4. Turn the rotor manually, clockwise, until the membrane pipe is fully extracted from the dispensing pump.

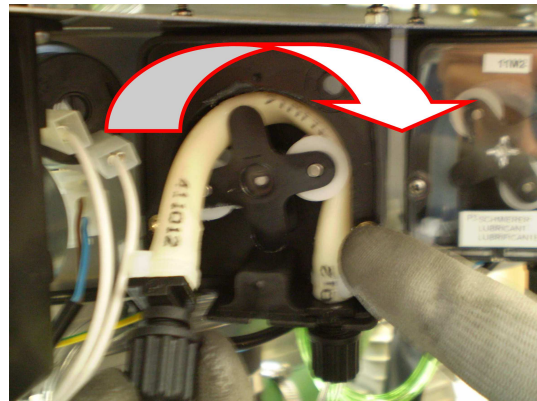

**ATTENTION: the rotor of dispensing pump turns ONLY clockwise !!!**

5. Place the membrane pipe in vertical position to help the flow of chemical product from membrane tube to chemical circuit. Do this operation to prevent leakage of chemical product during replacement.
6. Loosen the tube clamps and disconnect the product supply tubes from the membrane pipe attachments.



7. Replace the membrane pipe with an other the same type. (see the spare part list).



8. Replace the membrane pipe into dispensing pump, manually operating the rotor.

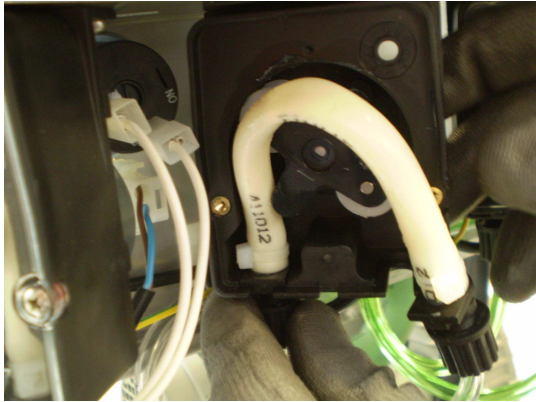

**ATTENTION: the rotor of dispensing pump turns ONLY clockwise !!!**

9. Replace the protective mask of the rotor.

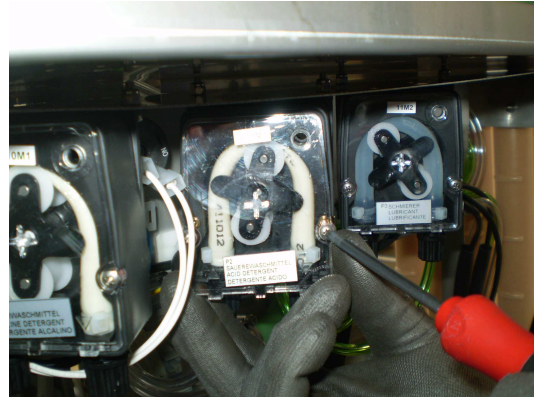

CLEANING OF DISPENSING PUMP FOR CHEMICAL PRODUCTS		
<b>M6</b>	Worker: <b>Is</b>	Frequency of Intervention: <b>from 3 to 6 months</b>
<b>METHOD OF INTERVENTION:</b> clean the pump for the dispensing of chemical products as described below:		
<ul style="list-style-type: none"> <li>• Remove the closure panel of the machine by removing the screws.</li> <li>• Access the chemical product pump. Use a tool to remove the protective mask of the rotor</li> <li>• Loosen the tube clamps and disconnect the product supply tubes from the membrane tube attachments</li> <li>• Turn the rotor manually, clockwise, until the membrane tube is fully extracted from the dispensing pump.</li> <li>• Apply an even layer of silicon grease to the membrane tube you have just removed before re-installing it on the dispensing pump, following the previously described operations in reverse order.</li> </ul>		

CLEANING OF SAFETY SIGNALS SURFACES		
	Worker: <b>Is</b>	Frequency of Intervention: <b>1 year</b>
<b>METHOD OF INTERVENTION:</b>		
Clean the safety signals surfaces with water or isopropyl alcohol, using a cloth.		

	<b>WARNING</b>
	In order to remove the scale, suitable products can be used, yet pay attention that they are not highly corrosive.

	<b>ASSISTANCE</b>
	Should your machine not work properly even after ordinary maintenance has been carried out, contact the Technical Support Centre of reference, describing the fault and giving the machine model and serial numbers.

# 19. PROBLEMS – CAUSES – SOLUTIONS

## 19.1 Introduction

This chapter includes possible problems which may occur during machine operation, along with their cause and solution.

All components, if not identified by specific figures, are referred to by the attached assembly drawings.

**Should the inconveniences continue or take place frequently even after having carried out all the instructions stated in this chapter, please contact the Technical Support Centre of reference.**

## 19.2 Problems - Causes - Solutions

### I. MACHINE WILL NOT START:

- C. Circuit breaker de-activated.
- R. Place it in the "ON" working position.
- C. Machine start switch de-activated.
- R. Press the start button.

### I. UPON GIVING START-UP COMMAND, WASHING CYCLE DOES NOT START:

- C. The door is not correctly closed or locked.
- R. Check door closure. Check that the door micro-switch is properly activated.
- C. Micro-switch failure.
- R. Check operation and replace as necessary.
- C. No detergent in tank.
- R. Turn the machine off and fill the tank.

### I. MACHINE DOES NOT REACH SET TEMPERATURE FOR THE SELECTED WASHING CYCLE:

- C. The thermostat probe of the washing chamber is dirty or covered with lime.
- R. Clean the thermostat probe of the washing chamber, performing the routine maintenance described in chapter 18 (Form M2) of this manual.

### I. MACHINE DOES NOT PROPERLY RUN WASHING CYCLE:

- C. The nozzles of the washing rotors are clogged by deposits or lime.
- R. Clean the rotors by carrying out the routine maintenance set forth in chapter 18 (Form M3) of this manual.
- C. Water required for proper washing does not arrive.
- R. Ensure that the water is supplied at the correct pressure and that there are no obstructions.
- C. The correct amount of water required for correct washing cycle does not arrive.
- R. Completely close the tap for connection to the plumbing system located upstream from the machine and clean the filter as described in chapter 18 (form M1) of this manual.

### I. DETERGENT FILLING PHASE DOES NOT OCCUR CORRECTLY:

- C. Chemical dispensing pump not very efficient.
- R. Perform the routine maintenance set forth in chapter 18 (Form M6) of this manual.
- C. Chemical dispensing pump failed.
- R. Contact the Technical Support Centre of reference and ask for the assistance of an **authorized workshop technician** for the repair or replacement of the pump.

**I. MACHINE DOES NOT PERFORM DRYING PHASE:**

- C.** Air filter of drying system is dirty or clogged.
- R.** Clean the filter by carrying out the routine maintenance set forth in chapter 18 (Form M5) of this manual.
- C.** The fan of the drying system does not work.
- R.** Check the electrical connections of the drying system.
- R.** Contact the Technical Support Centre of reference and ask for the assistance of an **authorized workshop technician** for the repair or replacement of the motor.



## 20. DECOMMISSIONING

### 20.1 Instructions for disassembly of the machine

For demolition and subsequent disposal of your machine, proceed as follows:

- Disconnect the machine from the electrical power and water supply, and from the drain. With the machine disconnected, check that the water circuit is not pressurized.
- Contact the organization responsible for reporting and certifying machine demolition, in accordance with the laws in the country where the machine is installed.
- Carry out draining, storage and subsequent disposal of substances such as oils and grease which may be in the lubrication tanks in accordance with the law.
- When disassembling the machine, make sure to divide the materials it is made of according to their chemical makeup (iron, aluminium, bronze, plastic, etc.).
- Ensure that the floor where the machine or any parts of it are placed is made of washable materials, non-absorbent, and provided with adequate drainage to protect against accidental oil leaks or rust. These drains must carry any leakage to watertight collection containers.
- Cover the machine or parts of it with insulating covers to prevent rain or humidity from damaging the structure through oxidation or rust.

**Following the legal requirements where the machine is installed and used, dispose of all materials and substances resulting from its disassembly.**

### 20.2 Machine disposal

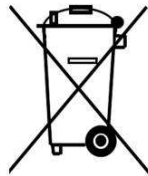

- For the dispose of the equipment get through to the manufacturer or distributor.
- Do not dispose of this equipment as miscellaneous solid municipal waste, but arrange to have it collected separately.
- The re-use or correct recycling of the electronic and electrical equipment (EEE) is important in order to protect the environment and the well-being of humans.
- In accordance with European Directive WEEE 2012/19/EC, special collection points are available to which to deliver waste electrical and electronic equipment and the equipment can also be handed over to a distributor at the moment of purchasing a new equivalent type.
- The public administration and producers of electrical and electronic equipment are involved in facilitating the processes of the re-use and recovery of waste electrical and electronic equipment through the organisation of collection activities and the use of appropriate planning arrangements.
- Unauthorized disposal of waste electrical and electronic equipment is punishable by law with the appropriate penalties.



EURONDA S.p.A.  
Via dell'Artigianato, 7 - 36030 Montecchio Precalcino (VI) - ITALY  
Tel. +39 0445 329811 - Fax +39 0445 865246 - Internet: [www.euronda.com](http://www.euronda.com) - E-mail: [info@euronda.com](mailto:info@euronda.com)