

# Washing Machine

**WAF 6150 A - WAF 6140 A**

**WAF 6120 A - WAF 6100 A**

**WAF 6080 A**

**User's Manual**

**Blomberg**

# Contents

---

1- Technical Features of Your Washing Machine	3
2- Warning	5
3- Preparation	7
4- Program Selection and Starting Machine	11
5- Care and maintenance	15
6- Installation	17
7- Before calling service	19

# 1 Technical Features of Your Washing Machine

	<b>WA 6150 A</b>	<b>WA 6140 A</b>	<b>WA 6120 A</b>	<b>WA 6100 A</b>	<b>WA 6080 A</b>
Maximum dry laundry capacity (kg.)	6	6	6	6	6
Height (cm.)	85	85	85	85	85
Width (cm.)	60	60	60	60	60
Depth (cm.)	54	54	54	54	54
Net Weight (kg.)	71	71	71	71	71
Electricity (V/Hz.)	230/50	230/50	230/50	230/50	230/50
Total Current (A)	10	10	10	10	10
Total Power (W)	2350	2350	2350	2350	2350
Washing -rinsing cycle (cyc/min)	52	52	52	52	52
Spinning cycle (max cyc/min)	1500	1400	1200	1000	800

There may be changes in the technical features without prior notice in order to enhance product quality.

The figures in the manual are schematic and may not represent your actual machine one-to-one.

Labelling on your product and ones declared in the documents accompanying product are the values obtained under laboratory conditions with given standards. These values may vary according to usage and environmental conditions.

# Your Washing Machine

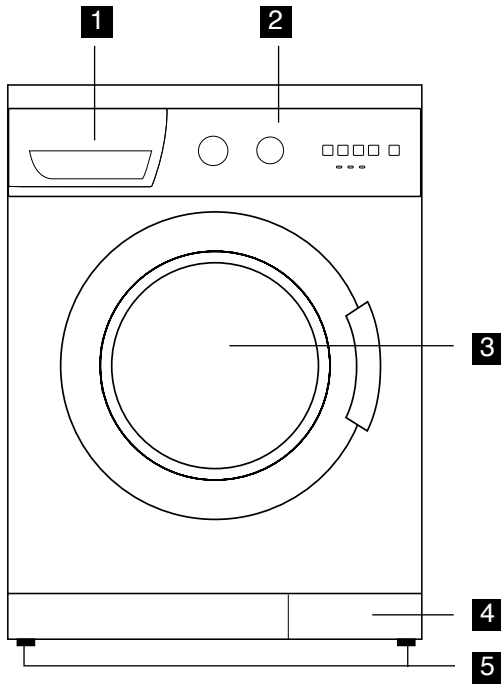

- 1** Detergent dispenser
- 2** Front Panel
- 3** Front door
- 4** Kick Plate Cover
- 5** Height-adjustable feet

## 2 Warning

---

- This product is designed for home use.
- Your washing machine is adjusted to 230V.
- If the fuse in your house is less than 16A than have a certified electrician deploy an 16A fuse.
- In case of transformer or non-transformer use, grounding installation must be performed with a licensed electrician. Any use before grounding is not our responsibility.
- In order to make your machine ready call Authorized Service, prepare clean tap water and water draining with licensed plumber.
- Never place your machine over a carpet covered floor. Otherwise electrical parts of your machine may overheat. This may cause malfunction of your machine.
- Make sure hot and cold taps are connected correctly. Otherwise your laundry may come out hot and torn .
- Please call certified service for a failure of electric plug / cable.
- Be careful about your water hoses are not old. Do not use old / torn water hoses. This may cause stain in your laundry .
- At first use, washing must be performed at Cotton 90°C program without loading with laundry for getting your machine ready for washing.
- Performance of your washing machine depends on the quality of water and hygiene compound used. If low quality and unfitting cleaning material is used the stains will be fixed. Before washing your laundry with stain keep your attention on cleaning the laundry as explained in following pages.
- This is period of keeping spare parts for your machine to operate. Because of quality control procedures there might be little amount of water in your machine. This does not have any damage to your machine.
- Your machine is programmed for starting operation again when electricity is off and on afterwards. You can not press On / Off button to cancel program. Machine will go on program when electricity is on. To CANCEL the program press >Start/Pause/Cancel< button for three seconds. (See. Cancelling a program)  
If “Door” led on program progress display is blinking program selection knob is middle position. In this case turn the knob and adjust it again. If the warning continues call authorized service.
- After your machine starts operation, if Start/Pause/Cancel key starts blinking than door is not locked. Open and close the door again begin washing program again.
- If the “washing” led on the program progress display is blinking either there is no water or tap is

off. Check your taps. Turn your machine off and on. If the problem persists unplug your machine, turn off tap water and call authorized service.

- If program is started and program selection can not be performed your machine might be in protection mode due to infrastructure problem (voltage, water pressure, etc.) Press and hold the > Start/ Pause/Cancel < button for 3 seconds in order to switch machine to factory settings.
- Most of the warnings resulting in calling an authorized service are due to infrastructure problems. For this reason applying to an Authorized Service is recommended.

### **3** Preparation

---

#### **Before starting your machine please beware of below mentioned points:**

- Did you plug the cable?
- Did you connect draining hose correctly?
- Did you close front door?
- Did you open tap water?

If you haven't installed your machine please read to "Installation" section.

#### **Sorting the Laundry**

Sort laundry according to type of fabric, color, level of dirtiness and allowed washing temperature. Do not wash white laundry together with colored ones. Remove hard parts like belt, wrist button, curtain buttons, etc. or place laundry in a cloth bag. Empty pockets. Zip up and button up. Very tiny laundry like baby clothes may get into inside of drum, midst of bellow, pump filter, hose, etc. in order to prevent this it is advised to place such laundry in a special laundry string bag or large laundry. See practical and useful information section for soiled laundry. Your machine can wash "Machine Wash" or "No-matting" labeled woolen with special woolen program. Delicate laundry with "Do not wash" or "hand wash" label (silk, cashmere, pure wool, etc.) can be washed in the special hand-wash program.

#### **Opening front door**

Pull the handle to open the front door. Your machine's front door is designed for opening during only machine is not operating. If the led displays "door" than door can open.

#### **Loading machine with laundry**

Fill the machine by unfolding and not squeezing laundry. Place hand-woven garments inside-out to the machine. Make sure there is no laundry jammed between bellow and front-door.

Close the loading door by pushing. If loading door is not properly closed machine will not start.

#### **Selection of detergent and softener**

Quantity of the detergent used depends on hardness of water and how soiled laundry is. Recommended values are indicated on the package. If your laundry is low soiled and/or hardness of water is low use less detergent as indicated on the package. Otherwise it may result in excessive foam.

You should use detergent specially designed for automatic washing machines. Avoid using bleach product containing sulfur or chlorine. Place powder detergent and softener in appropriate drawer compartment and close detergent dispenser.

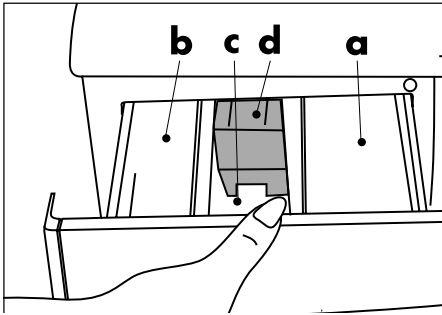

- a. Compartment I, powder detergent drawer for pre-wash.
- b. Compartment II, powder detergent drawer for main wash.
- c. Softener dispenser
- d. Siphon

Fill the softener as indicated (usually <100ml; 1 tea bag) on package. Never fill more than “MAX” level. Excess amount will drain to suction cup and be wasted. You might need to fill softener again. If softener is thickened over time add some water for thinning. Softener may obstruct siphon and block flow.



# Control Panel

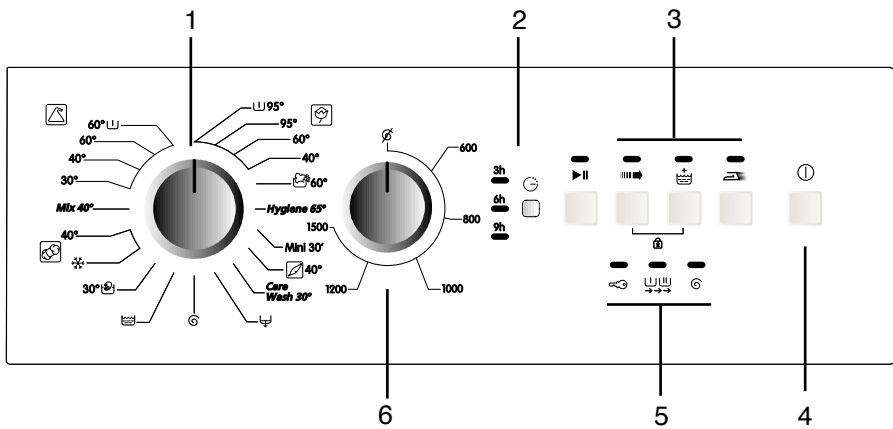

- 1- Program selection knob
- 2- Time delay selection button
- 3- Auxiliary function buttons
- 4- On / Off button
- 5- Program progress display
- 6- Spin speed selection knob

## **Auxiliary Functions**

### **Quick-wash**

Shortens washing time for lightly soiled fabrics.

### **Rinse plus**

By using this function your machine will add another rinse process to the three rinse processes that it has already done. This additional rinse will reduce any effects on sensitive skin by washing leftover detergent.

### **Anti-creasing**

To avoid wrinkling of your clothes, select this function. When Easy-iron is chosen please load less cloth, this way a special washing and spinning profile will reduce the wrinkles and your clothes will be easy to iron.

### **Spin speed selection knob**

You can spin the laundry up to 1500 cycle / min.(depending on model) with the models having cycle selection button. Your machine will spin not more than 800 cycle / min. for synthetic programs and 600-400 cycle/ min. for woollen programs.

In addition if you do not want to spin your laundry you may choose “No Spin” position.

## 4 Program Selection and Starting Machine

Plug your machine to outlet. Turn on the machine by pressing “On / Off” key. Open the door by pulling the handle and load the machine without exceeding loading capacity and close the door. Specify the appropriate program by looking at program selection table according to type of laundry, degree of soiledness and washing temperature. Position program selection key to desired washing program-temperature. Select convenient spin speed related to selected program. If

you are using auxiliary function press desired auxiliary function key. Afterwards place appropriate detergent and softener to your machine’s detergent drawer. Start your machine by pressing Start/Pause/Cancel button. Start/Pause/Cancel key’s led will be on. After your machine starts, you can follow from the program progress display at which step your machine is.

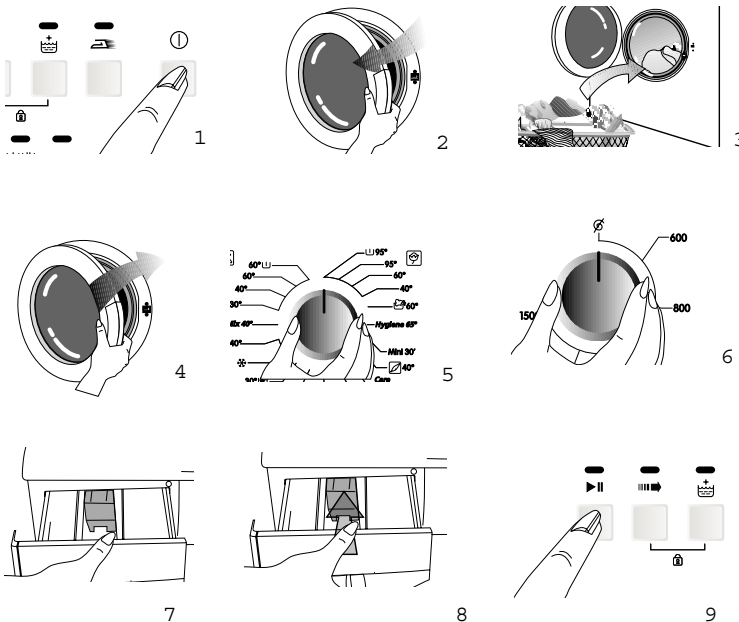

## Program selection table

Program	Type of laundry	Max Load (kg)	Program Duration (min.)	Water Consumption (lt)	Energy Consumption (kWh)	Quick wash	Rinse Plus	Anti-creasing
<b>Cotton 95 with Prewash</b>	Heavy soiled Durable fabrics made of cotton and linen	6	160	60	2.60		•	•
<b>Cotton 95</b>	Heavy soiled Durable fabrics made of cotton and linen	6	150	55	2.00	•	•	•
<b>Cotton 60 *</b>	Normal soiled cotton and linen durable to heat	6	135	49	1.14	•	•	•
<b>Cotton 40</b>	Less soiled cotton and linen sensitive to heat	6	125	49	0.70	•	•	•
<b>Intensive 60</b>	Heavy soiled Durable fabrics made of cotton and linen	6	160	65	1.30		•	
<b>Hygiene 65</b>	Normal oiled Durable fabrics made of cotton and linen (baby clothes etc.)	6	170	65	1.40		■	
<b>Synthetic 60 with prewash</b>	Normal soiled cotton/synthetic blended durable to heat	3	125	60	1.00		•	•
<b>Synthetic 60</b>	Normal soiled cotton/synthetic blended durable to heat	3	115	55	0.90	•	•	•
<b>Synthetic 40</b>	Less soiled cotton/synthetic blended durable to heat	3	105	55	0.50	•	•	•
<b>Synthetic 30</b>	Very Less soiled or cotton/synthetic blended sensitive to heat	3	90	55	0.30	•	•	•
<b>Mix 40</b>	Very Less soiled or cotton/synthetic blended sensitive to heat	3.5	95	55	0.50	•	•	•
<b>Delicate 40</b>	Delicate, sensitive synthetic, cotton blended	2	70	60	0.35		•	•
<b>Delicate 30</b>	Delicate, sensitive synthetic, cotton blended	2	65	60	0.25		•	•
<b>Woolen 40</b>	Woolen and delicate blended with machine wash label	1.5	55	55	0.30		•	
<b>Woolen Cold</b>	Woolen and delicate laundry with machine wash sign	1.5	45	55	0.03		•	
<b>Handwash 30</b>	Special program for silk, cashmere or laundry with no machine wash sign	1	40	35	0.15			
<b>Mini 30</b>	Special program for silk, cashmere or laundry with no machine wash sign	2.5	30	45	0.25			
<b>Rinse</b>	Rinse Program	6	23	13	0.04			
<b>Spin</b>	Spin Program	6	13	–	0.03			
<b>Pump</b>	Pump Program	–	2	–	–			

\* Energy Labeling Program (EN 60456)

## Pressing “On/Off”

By pressing “On/Off” button you can make your machine ready for selecting program. When “On/Off” key is pressed “door” led will light on meaning “door can open”. Press “On/Off” key again for turning your machine off.

Pressing “On/Off” does not mean program started operation. You must press “Start/Pause/Cancel” for starting the program.

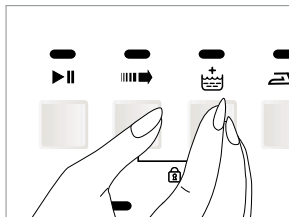
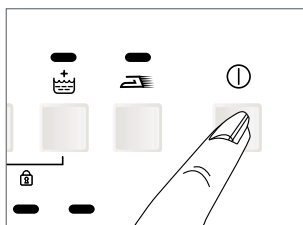

## Function Selection

Additional functions selectable according to selected program can be selected by pressing related key. Led of selected function will be on.

If not selected together some additional functions go off when it is not selected with other one. For example; when using cotton program, express and rinse plus auxiliary functions can not be selected together. After selecting express program, if rinse plus key is pressed fast program will be on and express function led will go off.

## Child-proof lock

During washing laundry in order to maintain that program progress is not affected by pressing keys by children there is child-proof lock. To enable child-proof lock, after washing begins, press Express and Rinse Plus function buttons together simultaneously for three seconds. Pre-wash additional function led will always blink.

After program ends in order to start a new program or alter the program you have to disable child-proof lock. To do this press same buttons for three seconds and Child-proof lock led will be off.

## Program Progress

After machine starts operation relevant program led on program progress display will be on. When a step is completed that step's led is off and next step's led is on. When “On/Off” button is pressed “door” led will be on. After washing program is selected when “Start/Pause/Cancel” key is pressed “Washing” led on program progress display will be on. At the final step “Spin cycle” led is on. When program is completed “Door” led will be on again. During machine operation you can press “Start/Pause/Cancel” key for getting machine to “Pause” position. In this case “Start/Pause/Cancel” led will blink.

## Changing Program

You can use this feature for washing laundry in the same textile group for washing at lower or higher temperatures. For example, instead of Cotton60, Cotton40 can be used. For selecting Cotton40 instead of Cotton60 by pressing “Start/Pause/Cancel” key machine is switched to pause position. Program knob is turned for selecting Cotton40 program.

Even when the program selection button is changed during the program initially selected program will be executed. For changing washing program continuing program must be cancelled. (See Cancelling a program)

For selecting auxiliary functions or spin speed necessary changes can be performed after pressing Start/Pause/Cancel button. Although selected auxiliary functions must be compatible with washing program. For example when your machine is intensive program you can select additional rinse plus function but you can not select express.

### Time delay for program start

Using time delay key you can delay the starting of the selected program for 3 hours, 6 hours or 9 hours.

When time delay key is pressed once 3hours delay is adjusted and led will light on. If same key is pressed once more delay is 6hours, and if it is pressed once more 9 hours delay is selected. If time delay key is pressed again delay is cancelled. After the selection of time delay when “Start/Pause/Cancel” is pressed program

can be started with delay. During delay period door can be opened or laundry can be added

After time delay is initiated by pressing “Start/Pause/Cancel” you can switch machine to “Pause” mode and change delay time.

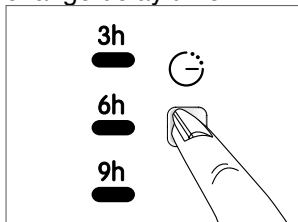

### Adding laundry

If you want to add laundry to your machine after program begins press Start/Pause key for switching machine to pause mode. If water level in the machine is appropriate “door” led on program progress display is on and laundry can be added to the machine. If “door” led is not on after one minute than water level in the machine is not appropriate and laundry can not be added. You can press “Start/Pause/Cancel” key for continuing program.

### Canceling a Program

For canceling a program “Start/Pause/Cancel” key is pressed for three seconds. After this period “Start/Pause/Cancel” and all other leds will be off .You can select a new program and start washing.

If cancel task is performed during washing “Spin” led on display will light on, machine will pump and when “Spin” led is off “door” led will be on, door can be opened and new pro-

gram can be selected.

Even program selection button is changed during the program initially selected program will be executed.

For changing washing program “Canceling a program” must be performed afterwards new program can be selected and started

After machine starts operation even if spin speed or washing temperature is changed, initial speed and temperature is valid. In order to change spin speed or temperature after pressing “Start/Pause/Cancel” new cycle or temperature can be selected.

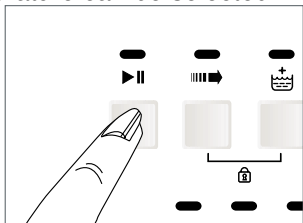

## Emptying Laundry

After program ends machine automatically stops. Turn off tap water. Pull the handle and open loading door. Turn off your machine by pressing “On/Off”. After taking laundry out keep the loading door open and let the drum ventilate. Check the bellow and clean.

## End of Program

When program ends “door” led will light on and door can be opened and machine is ready for next washing. Press “On/Off” for turning machine off.

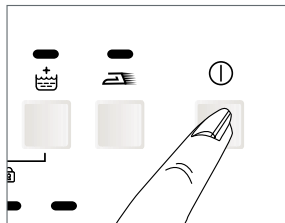

## 5 Care and maintenance

### Detergent Dispenser

Powder detergent residue may accumulate in drawer after a while. In order to clean detergent drawer press the marked point of the siphon on softener compartment and push the drawer towards yourself. Wash the drawer with water

### Siphon

Do not neglect cleaning suction cup when it becomes soiled. In order take suction cup out first take detergent drawer out. Clean it in order to eliminate blocking by softener residue. After cleaning place suction cup to its place and make sure it is placed properly.

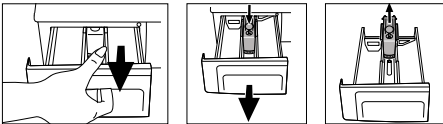

### Water Entrance Filters

There is a filter at each flat end where water inlet hose is connected to tap and at each of water inlet valve placed behind the machine. These filters blocks entrance of foreign objects and dirts to the machine. Filters must be cleaned regularly to avoid clogging. For doing this, turn off tap water. Pull out water inlet hoses. Clean the top of the water inlet valve filter with a brush. If filters are extremely clogged you can pull it out with a pincer. You can take out the flat side of water inlet hoses with its seal and clean with tap water. (2 filters in Single water inlet machines, 4 filters in double water inlet machines)

### Hose

There is risk of freezing in cold

region, if your machine is placed in a cold place remaining water in hoses must be drained with pump filter when machine is not used. Water inlet hoses can be drained by taking it out from tap.

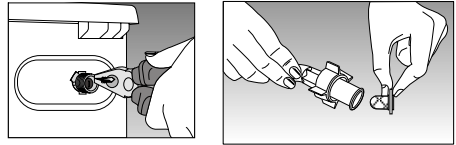

### Cleaning Pump Filter

There is filter system maintaining long lifetime of pump by blocking foreign objects like button, cloth fiber enter to the pump during drain of washing water. It is useful to clean the filter when it is soiled.

In order to do this:

Unplug your machine. Open the filter at bottom right corner by pressing marked space on the lid.

Hot water risk: There might be 15 lt., 90°C hot water in the drum. Open the filter carefully.



Before opening the filter drain the water with drain hose. Pull out the drain hose from its place. Prepare a suitable container and open the tap of hose. After water is drained place the tap properly. Open the filter by turning and drain the remaining water (max30ml) to filter tap. Clean remaining foreign object in the filter. When



finished turn in clockwise direction and close. Close the filter tap by pushing.

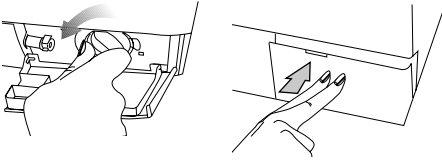

**Caution!**

If the filter and hose tap does not fit, it leaks water.

## 6 Installation

If your system is not ready, let a certified plumber make it ready.

### 1. Removing the transportation safety bolts

Before the washing machine is operated, the transit bars must be removed! In order to do this:

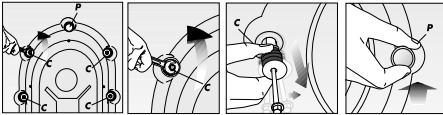

1. Loosen “C” bolts by rotating them counter clockwise with a suitable spanner
2. Remove transportation safety bolts by turning.
3. Place “P” plastic covers onto the openings of transportation locks by rotating in direction of arrow and pushing.

Attention please! Keep the transit bars for using when machine is to be transported again. Always transport your machine with transportation locks.

### 2. Leveling the feet

In order to operate your machine without noise and vibration it must be properly on balance. Four feet of your machine can be adjusted. First loosen the plastic counter bolt. Tighten the counter bolt after adjusting the feet for leveling your machine.

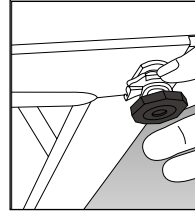

### 3. Water Connections

#### a) Water Inlet Hose

Your machine is connected to water supply by special hoses supplied by the machine. Red hose or hose written red on it is hot water inlet, blue hose or hose written blue on it is cold water inlet.

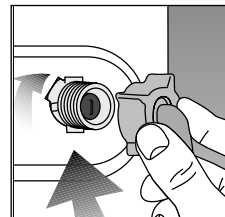

There are plastic seals (4 for double

water inlet models, 2 for single water inlet models) on hose or plastic bag for eliminating any leakage in connections points. These seals must be used on each side of the connection. Seals on machine side must be connected filter cannal.

After connecting the hose, check all connections for leaks In order to eliminate any risk due to water leakage keep the taps off when machine is not used.

Your machine will operate efficiently if the water from tap is minimum 1 and maximum 10 bars. Practically 1 bar means 8 liters of water in one minute when tap is fully on.

Connect hose to the machine. Tighten bolts with hand power, do not use spanner. Double inlet models can be used with blind cap as a single inlet machine. Connect blind cap to hot water inlet. Seal must be for stopping water leakage.

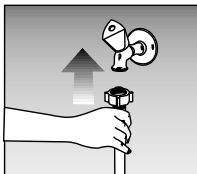

Do not connect single inlet machine to hot water. If machine is connected with Y part to a double inlet and over 40°C for single inlet machines, machine may switch to protection mode.

#### **b) Water drain hose**

Water drain hose could be placed either at the side of the bath tub, or directly to the drain. The hose should not be bent. Water drain hose should be secured with the holder so that it would not fall down on the ground. The hose should be placed between

40 and 100 cm. from the ground. Water drain hose could be placed directly to the drain water inlet.

#### **4. Electrical connection**

Connect the power cord to the appropriate electrical system which is being supported by the maximum voltage and current rating indicated on the rating plate placed inside the kick plate.

Look! Page 1, Steps before operating Fullautomatic Washing Machine and safety precautions.

Make sure that you have grounded power outlet.

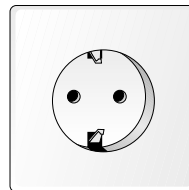

Attention! Before any operation of the machine check the following.

- Did you close the front door?
- Is the tap open?
- Is water drain hose placed properly?
- Is power connected?

## **7** Before calling service

---

### **You turned the machine on, but the leds are off on the panel.**

Check the grounding on the power cable or a blown fuse. Check the front door proper closure.

### **Machine does not take water.**

Check the front door for proper closure. Either taps are closed or water intake filters are clogged.

### **Taken water is directly discharged.**

Check if the discharge hose placed as described in the users manual or not.

### **Water coming from beneath the machine.**

Check the water intake and drain hoses. Tighten the connections. The washers of the hoses may be worn out. If non of the both, the pump filter is not closed properly.

### **Foam coming out of the detergent dispenser.**

Check whether your detergent is suitable for automatic machines. Next time use less detergent.

### **Pump does not drain water.**

Clean the pump filter. Check whether the drain hose is bent or not. If there is need to clean the pump filter, refer to the pump filter cleaning section of the manual.

