

# INSTRUCTION BOOKLET

**READ AND KEEP  
THESE INSTRUCTIONS**

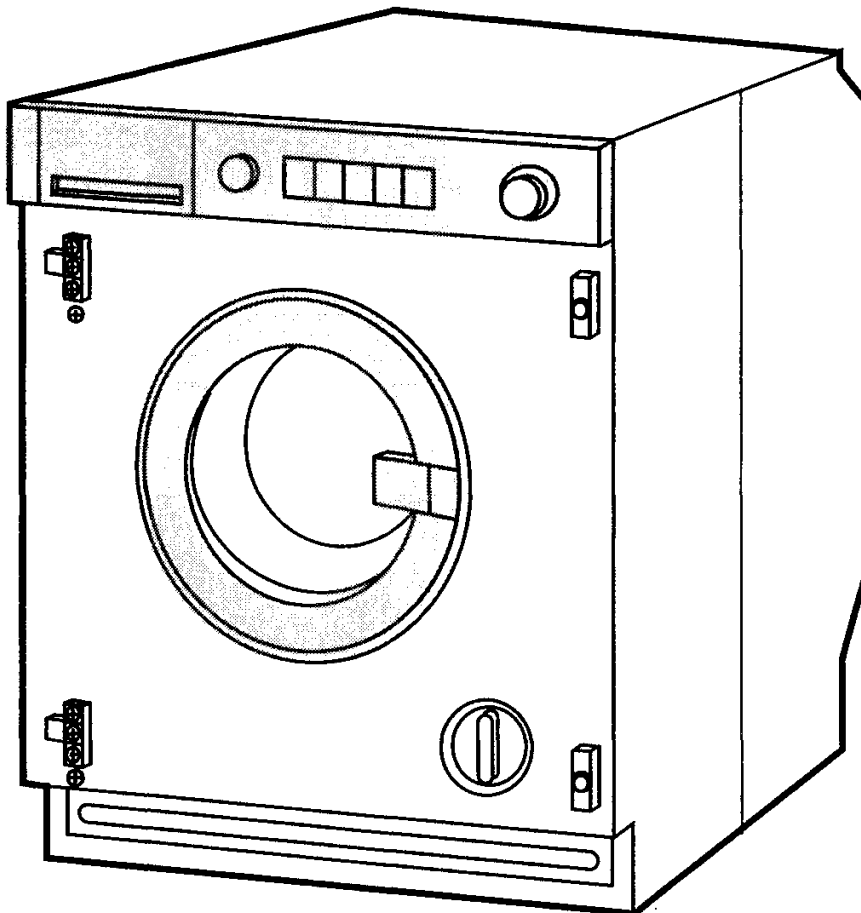

**WASHER DRYER  
WDI 1215 W  
WDI 1215 B**

---

# ZANUSSI

## INDEX

Page 2	Technical specifications
Page 3	Warnings
Page 4	The control panel
Page 6	Your machine
Page 7-10	Installation instructions
Page 11-14	Use of controls
Page 16-17	The washing and drying programmes
Page 18-19	Use of detergent and additives
Page 20-21	Washing 4 kg of white cotton at 95°C
Page 22-23	Washing 2 kg of delicate synthetic fabrics at 40°C
Page 24	Drying 2.25 kg (5 lb) of cotton
Page 25	Autodrying 1 kg (2.2 lb) of mixed fabrics
Page 26	Hints on washing and drying
Page 27	Maintenance
Page 28	Cleaning the filter
Page 29	Door Reversal & Building Under
Page 31-33	Servicing
Page 34-38	Zanussi Service Force
Page 39	Zanussi guarantee conditions
Page 40	5 Year cover

## TECHNICAL SPECIFICATIONS

DIMENSIONS	Width	60 cm (23.6")
	Height	82 cm (32.3")
	Depth	54 cm (21.3")
ELECTRICAL CONNECTION	Voltage	220/240V - 50Hz
	Maximum power absorbed	2550 W (13A)
WATER PRESSURE	Minimum (hot)	5 psi
	Minimum (cold)	7 psi
	Maximum	110 psi
MAXIMUM RECOMMENDED LOAD FOR WASHING	Cotton, linen	4.5 kg (10 lb)
	Synthetics, delicate fabrics	2 kg (4.5 lb)
	Wool	1 kg (2.2 lb)
MAXIMUM RECOMMENDED LOAD FOR DRYING	Cotton, linen	2.25 kg (5 lb)
	Synthetics	1.5 kg (3 lb)
SPIN SPEED	Maximum	1200 r.p.m.

# WARNINGS

**It is most important that this instruction book should be retained with the appliance for future reference. Should the appliance be sold or transferred to another owner, or should you move house and leave the appliance, always ensure that the book is supplied with the appliance in order that the new owner can get to know the functioning of the appliance and the relevant warnings.**

---

- ▲ This appliance is designed to be operated by adults. Children should not be allowed to tamper with the controls or play with the product.
  - ▲ It is dangerous to alter the specifications or attempt to modify this product in any way.
  - ▲ Any electrical work required to install this appliance should be carried out by a qualified electrician or competent person.
  - ▲ Any plumbing work required to install this appliance should be carried out by a qualified plumber or competent person.
  - ▲ This product should be serviced by an authorised Zanussi Service Centre, and only genuine spare parts should be used.
  - ▲ Care must be taken to ensure that the appliance does not stand on the electrical supply cable.
  - ▲ Always unplug the appliance and turn off the water after use.
  - ▲ Do not overload the appliance. See relevant section in instruction book.
  - ▲ Always look through the glass door to check if water has drained before opening the door. If water is present do not open door before draining the water. If in doubt, refer to your instruction book.
  - ▲ This appliance is heavy. Care should be taken when moving it.
  - ▲ All packing and transit bolts must be removed before use. Serious damage can occur to the product and to property if this is not adhered to. See relevant section in instructions.
  - ▲ The glass door becomes very hot during the washing cycle. Keep children away from the vicinity of the appliance whilst it is in operation.
  - ▲ Leave the porthole door slightly ajar between washes to preserve the door seal.
  - ▲ Only wash fabrics which are designed to be machine washed. If in doubt, consult the manufacturer of that item.
  - ▲ Before washing, ensure that all pockets are empty and buttons and zips are fastened. Avoid washing frayed or torn articles and treat stains such as paint, ink, rust, and grass before washing. Underwired bras must not be machine washed.
  - ▲ Any objects such as coins, safety pins, nails, screws, stones or any other hard, sharp material can cause extensive damage and must not be placed into the appliance.
  - ▲ Before selecting a programme or changing an ongoing programme the machine must be switched off by depressing the ON/OFF push-button.
  - ▲ Garments which have been in contact with volatile petroleum products should not be machine washed. If volatile cleaning fluids are used, care should be taken to ensure that the fluid is removed from the garment before placing in the machine.
  - ▲ Wash small items such as socks, laces, washable belts etc in a washing bag or pillow case as it is possible for such items to slip down between the tub and the inner drum.
  - ▲ Only use the advised quantities of fabric softener. Damage to the fabric can ensue if you over-fill. Refer to the manufacturer's recommendations of quantities.
  - ▲ As some duvets and eiderdowns should be washed/dried in large commercial machines because of their bulk, please check with the manufacturer of the item before washing in a domestic machine, even if the dry weight of the item is within the limit advised.
  - ▲ Only tumble dry fabrics which are designed to be tumble dried. If in doubt, consult the manufacturer of that item.
  - ▲ If it is necessary to open the door during the drying cycle, take care not to touch the inside of the glass porthole as this gets very hot.
  - ▲ Never tumble dry items that have had contact with chemicals such as dry cleaning fluid. These are of a volatile nature and could cause an explosion. Only tumble dry items which have been washed in water or require airing.
  - ▲ The users should always check that they have not left their gas lighters (disposable or otherwise) in their clothing.
  - ▲ Before the drying cycle always remove reusable plastic detergent dispenser designed to be placed inside the drum with the clothes as the plastic used is not designed to withstand the heat of the drying cycle.
  - ▲ Pets and children have been known to climb into washing machines. Please check your drum before use.
  - ▲ If the machine is situated on a carpeted floor, please adjust the feet to ensure that air can circulate freely.
  - ▲ Under no circumstances should you attempt to repair the machine yourself. Repairs carried out by inexperienced persons may cause injury or more serious malfunctioning. Contact your local Zanussi Service Centre. Always insist on genuine ZANUSSI spare parts.
-



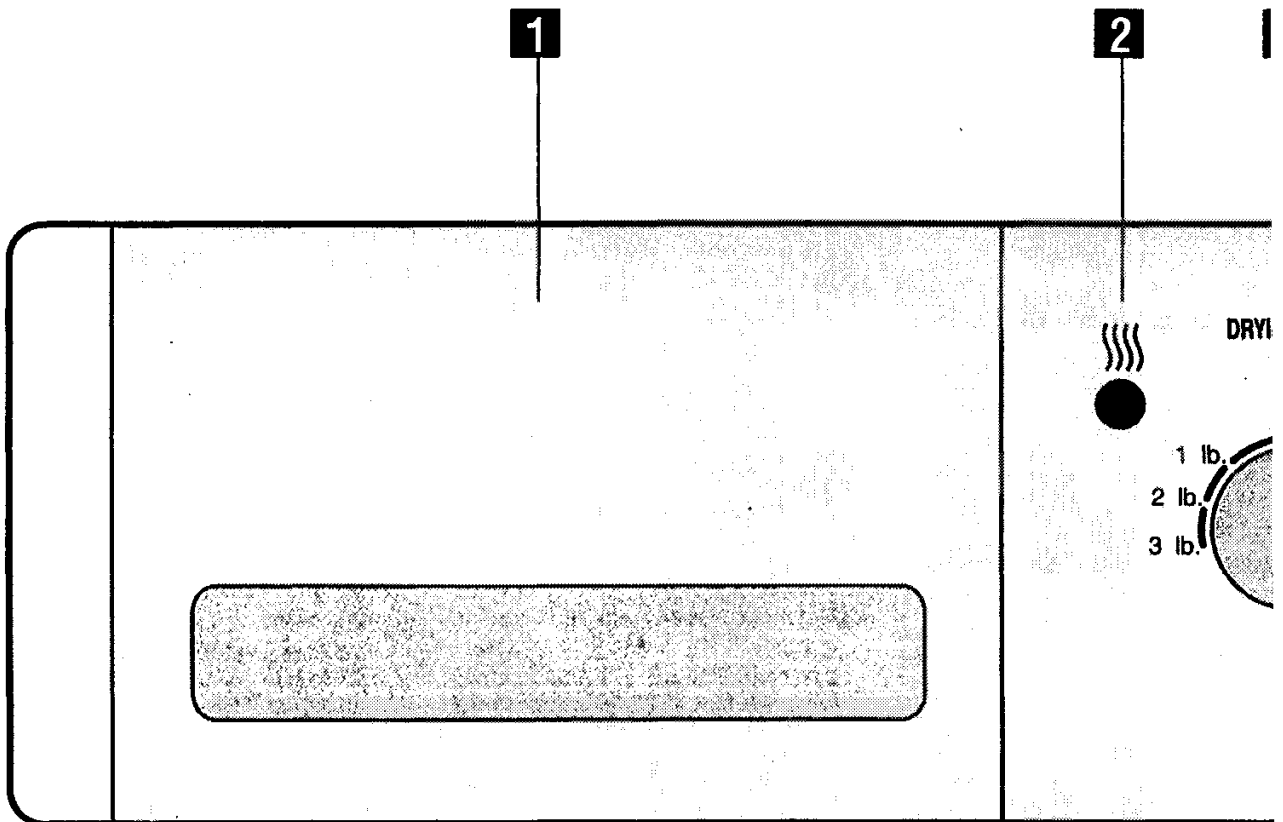

# THE CONTROL PANEL

Keep this page open while reading the booklet



## SYMBOLS

Symbols provided on the control panel have the following meaning:

-  Pilot light
-  Prewash compartment
-  Wash compartment
-  Softener compartment

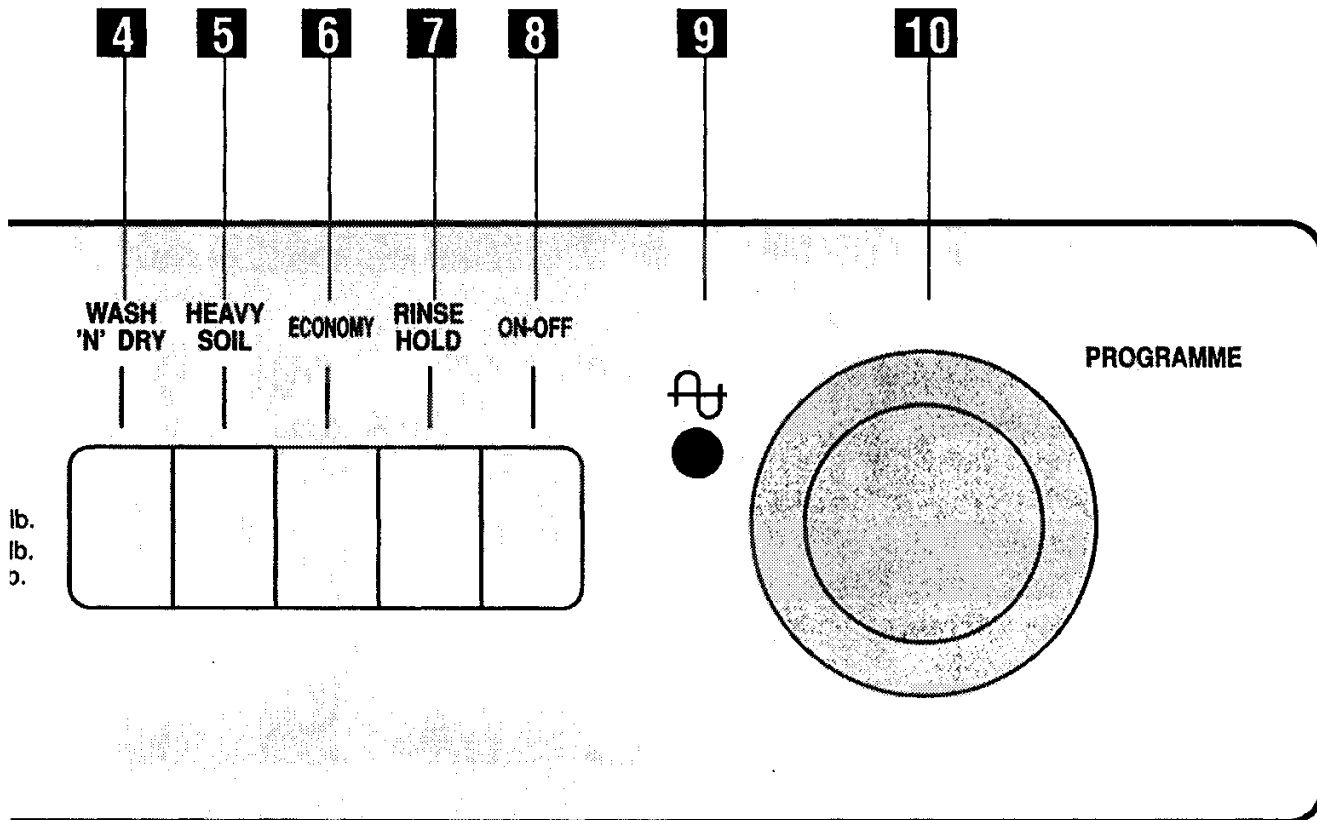

**1** Programme chart

**2** Dryer indicator light

**3** Drying time control

**4** Wash'n' Dry push button

**5** «Heavy soil» push button

**6** «Economy» push button

**7** «Rinse hold» push button

**8** On/Off-push-button

**9** Operating pilot light

**10** Programme control

# YOUR MACHINE

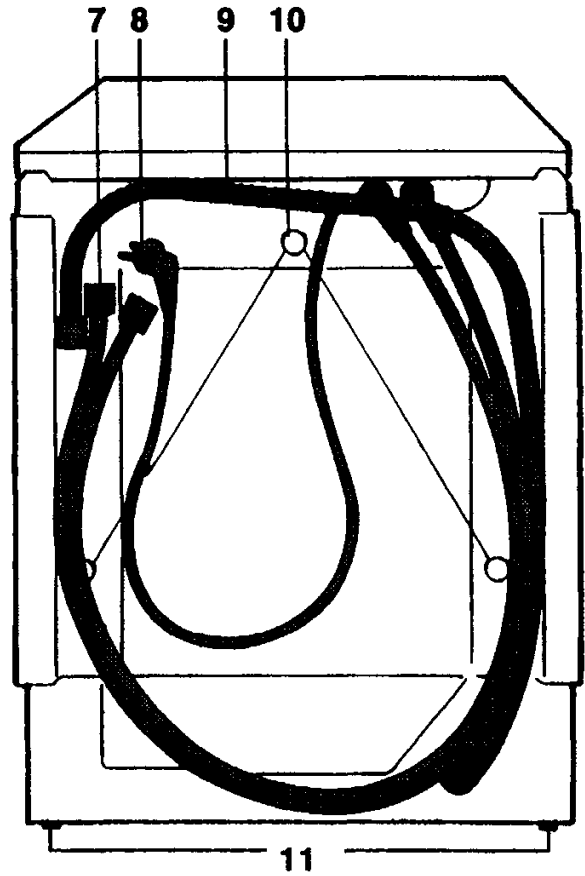
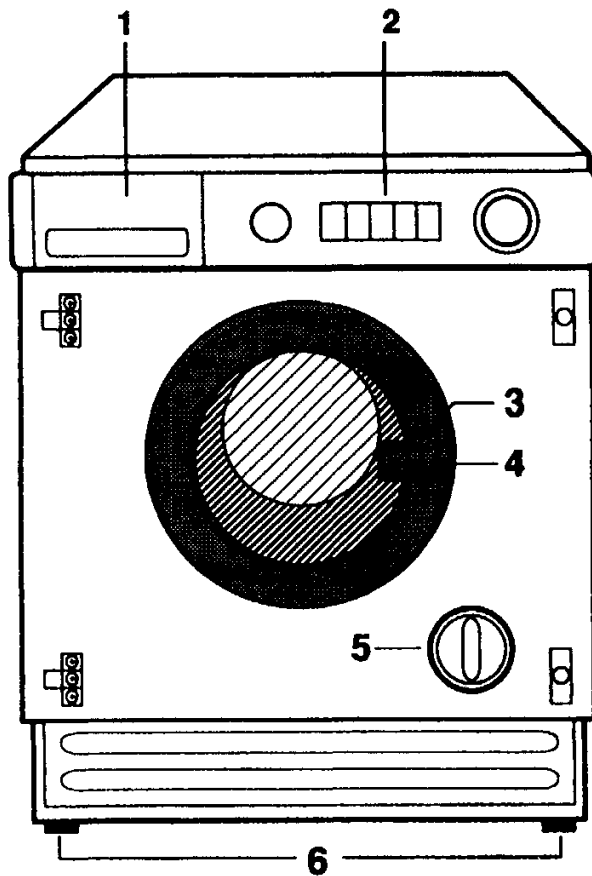

- 1 Washing powder dispenser drawer
- 2 Control panel
- 3 Door locked light
- 4 Door catch
- 5 Drain Filter
- 6 Adjustable feet

- 7 Water inlet hoses
- 8 Mains lead with plug
- 9 Drain hose
- 10 Transport safety screws
- 11 Rollers

# INSTALLATION INSTRUCTIONS

## CAUTION

Before starting the machine up, the packing must be removed as follows.

## NOTE

You are advised to keep all the packing for re-use in case the machine has to be transported again.

**1**

Unscrew and remove the rear right screw using a spanner.

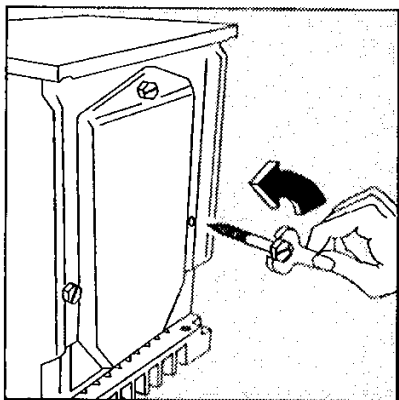

**2**

Lay the machine on its back making sure that the hoses are not squashed.

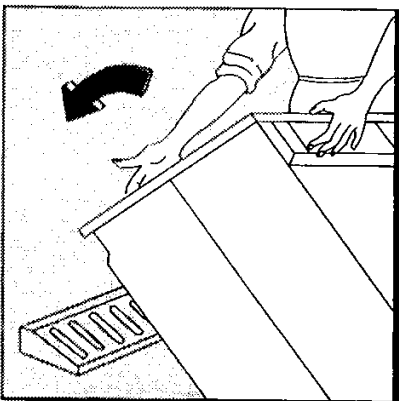

**3**

Remove the polystyrene base and take off the bottom panel by unscrewing the central screw.

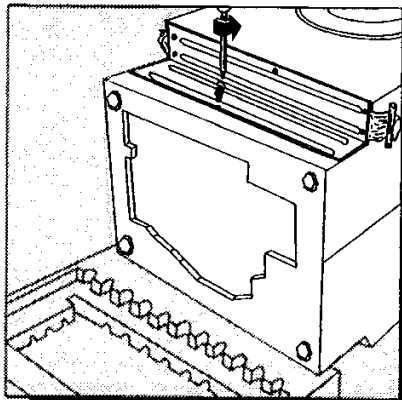

**4**

Carefully remove the right polythene bag.

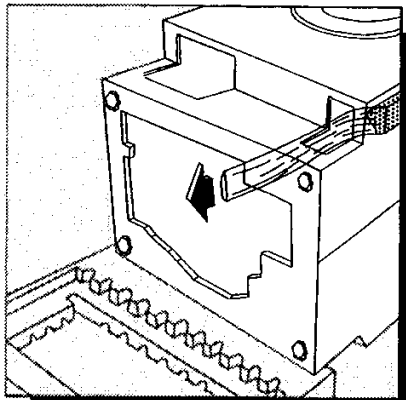

**5**

Carefully remove the central and left polythene bags.

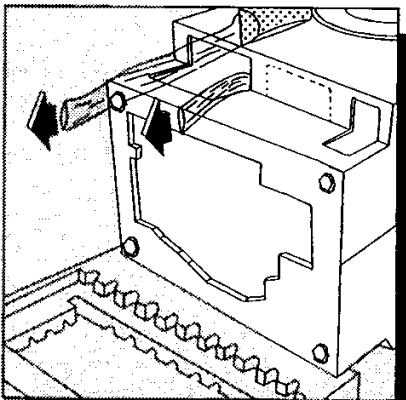

**6**

Re-fit the bottom panel using the 4 screws supplied with the booklet and the previously removed screw.

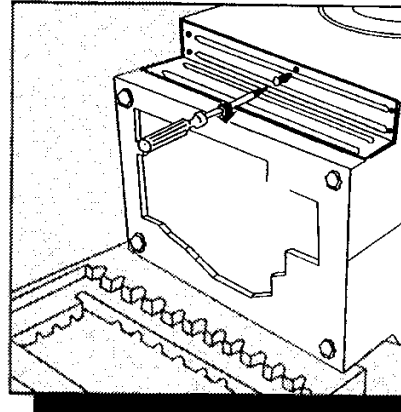

**7**

Set the machine upright and unscrew the two remaining rear screws.

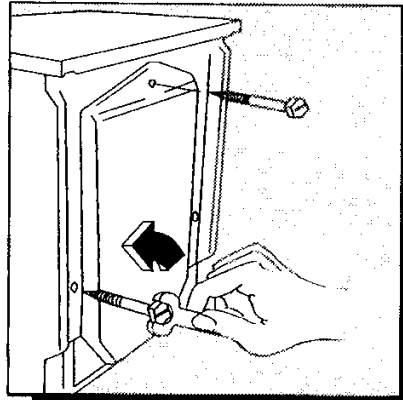

**8**

Slide out the 3 plastic pins and stop the holes with the plastic plugs supplied with the instruction booklet.

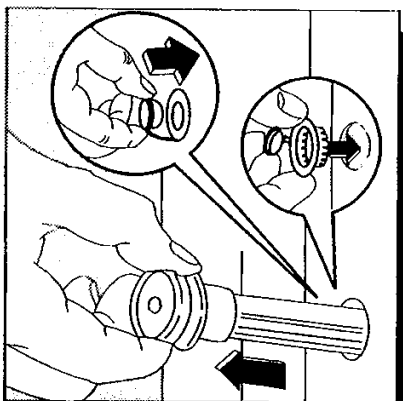

# INSTALLATION INSTRUCTIONS

**9**

Your new Zanussi washing machine has been designed to be permanently plumbed in to your home's water supply and drainage system. However, if this is not possible, it may be connected to suitable existing taps, with the drain hose discharging into a sink.

The appliance has two inlet valves, hot and cold, with female 3/4" BSP thread connectors. If this connection size is not compatible with the plumbing of the existing installation, a variety of connectors are available from good hardware stores and plumbers merchants to suit most domestic plumbing. Any alterations to your existing plumbing must be carried out by a competent person, or qualified plumber.

**10**

The inlets on the back of the appliance are colour coded, blue for cold, red for hot.

Before connecting the hoses be sure to fit the mesh filters supplied as per diagram.

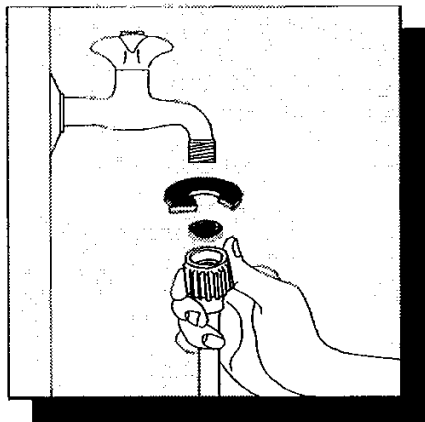

If only a cold water supply is available, connect the two hoses to a cold water outlet by means of a «Y» connection piece.

Installation should comply with local water authority and building regulations' requirements.

The appliance must be given a separate cold water supply and not be connected to a mixer tap, a single outlet water heater or a booster pump. A minimum water pressure of 7 psi is required for safe operation of the appliance.

If you cannot make the cold water connection direct from the rising mains, you may be able to operate the appliance from your cold water storage system.

There should be a minimum distance of 5.02 m (16½ ft) between the appliance's inlet and the bottom of the tank.

There will be sufficient pressure for the hot water supply from the hot water cylinder if the height between the appliance's inlet and the bottom of the cold water storage cistern (not between the appliance and hot water cylinder) is at least 2.74 m (9 ft).

**11**

Set the hose correctly by loosening the ring nut. After positioning the inlet hose, be sure to tighten the ring nut again to prevent leaks.

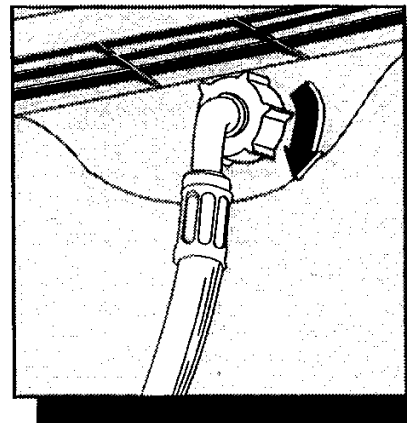



# INSTALLATION INSTRUCTIONS

**12**

If you intend the drain hose from the machine to empty into a sink, make sure the sink is empty and that the plug hole is not blocked.

If the machine is permanently plumbed in, hook the end of the hose into a standpipe installed for the purpose.

The standpipe must have an internal diameter of at least 30 mm (1 ½ in), in order that there is an air gap between the drain hose and standpipe. Make sure, that it is designed in such a way, that the end of the drain hose cannot be covered with water.

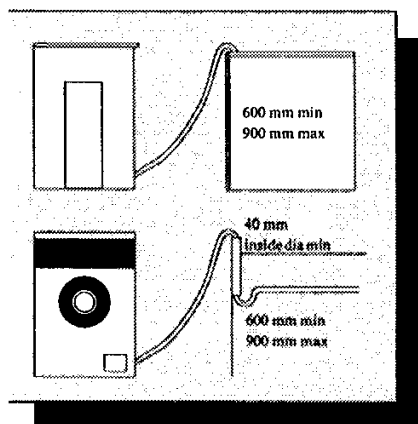

**Important:** Before connecting up the machine to new pipework or to pipework that has not been used for some time, run off a reasonable amount of water to flush out any debris that may have collected in the pipes.

Whether discharging into a sink or a standpipe check that the end of the drain hose is neither too high nor too low. The top of the curve in the hose's end should be no more than 90 cm (35.4") and no less than 60 cm (23.6") above floor level.

**13**

## ELECTRICAL CONNECTION

### WARNING:

### THIS APPLIANCE MUST BE EARTHED

**The manufacturer declines any liability should this safety measure not be observed.**

If the plug that is fitted to your appliance is not suitable for your socket outlet, it must be cut off and the appropriate plug fitted.

The cut off plug should be disposed of to prevent the hazard of electric shocks in case it should be plugged into a 13 Amp socket in another part of your home.

### Important

The wires in this mains lead are coloured in accordance with the following code:

GREEN AND YELLOW - EARTH  
BLUE - NEUTRAL  
BROWN - LIVE

If you fit your own plug, the colours of the wires in the mains lead of your appliance may not correspond with the markings identifying the terminals in your plug, this is what you have to do:

Connect the green and yellow (earth) wire to the terminal in the plug which is marked with the letter «E» or the earth  $\perp$  symbol or coloured green, or green and yellow.

Connect the blue (neutral) wire to the terminal in the plug which is marked with the letter «N» or coloured black.

Connect the brown (live) wire to the terminal which is marked with the letter «L» or coloured red.

The plug moulded on to the cord incorporates a fuse. For replacement, use a 13 Amp BS 1362 fuse.

Only ASTA approved fuses should be used.

The fuse cover/carrier must be replaced in the event of changing fuse.

The right fuse cover/carrier colour is the one shown by the coloured insert at the base of the plug.

The plug must not be used if the fuse cover/carrier is lost.

A replacement cover/carrier must be obtained from Zanussi Service Agents whose addresses are listed on the attached «Zanussi Service Force Directory» or you could find your local agent by looking in your telephone directory under "Z".

**This appliance complies with E.E.C. directive no. 87/308 of 2.6.87 relative to radio interference suppression.**

# INSTALLATION INSTRUCTIONS

**14**

Level the washing machine by loosening or tightening the feet. Accurate levelling prevents vibration, noise and displacement of the machine during operation. After levelling the machine, secure the feet by tightening the ring nuts.

Some vibration is inevitable, especially if mounted on a wooden floor.

Sprung wooden floors are particularly susceptible to vibration. For advice, consult a builder. If possible, always place the machine on a solid floor.

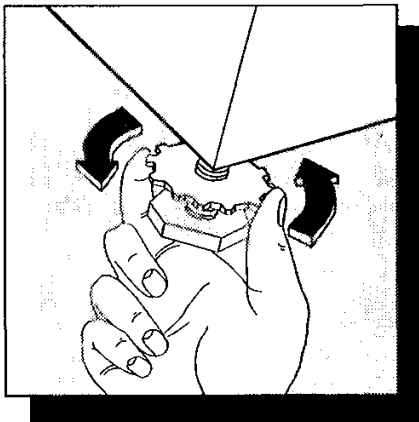

**15**

## Special conditions

If the floor is carpeted with a deep-pile carpet or covered with crumbly or soft material, insert a rigid support base under the feet to prevent noise, vibration or displacement. The base should protrude a few centimetres beyond the edges of the machine.

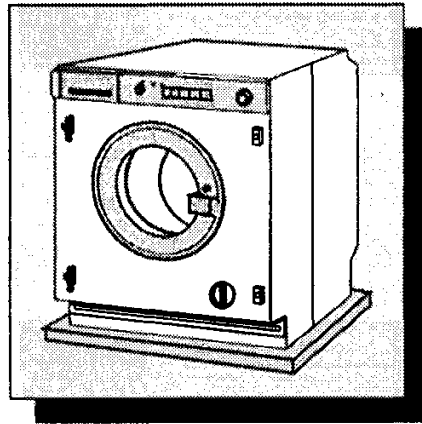

**NOTE**

Please ensure that when the appliance is installed it is easily accessible for the engineer in the event of a breakdown.

**All plumbing and electrical work required to install this appliance must be carried out by competent persons or qualified plumbers or electricians.**

# USE OF CONTROLS

1

## WASHING POWDER DISPENSER DRAWER

The washing powder or liquid and additives must be placed in this drawer before starting the programme.

A pull-out programme chart is available inside the drawer handle.

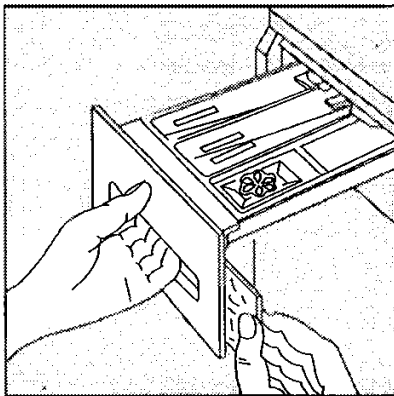

2

## DRYER INDICATOR LIGHT

This light will come on when the machine is drying.

3

## DRYING TIME CONTROL

Press the control knob to pop it out.

This control allows you to choose the desired drying time according to the type and quantity of the load to be dried.

It can also be adjusted whilst the machine is in operation to either increase or reduce the drying time. The control incorporates two drying cycles, both of them up to 80 minutes duration. The high temperature range for cotton and linen items is marked with a continuous line, and the low temperature range for synthetic fabrics with dotted line.

4

## WASH'N' DRY BUTTON

When washing only a half load or less, it is possible to programme the machine to run automatically from a wash programme to the drying programme without pausing.

To do this, first select the required wash programme.

Depress the Wash'n' dry button and then select the required drying time.

**The «Rinse Hold» option should not be selected.**

After completing the washing cycle, the machine will automatically begin the drying phase.

Refer to programme chart (p. 16-17) for the programmes with which this button can operate.

5

## HEAVY SOIL BUTTON

By pressing the heavy soil button, the machine will take in cold water only on programmes with a water temperature of 60°C and hotter.

These would normally be hot and cold, or hot fill only.

The water is then gradually heated to the required temperature.

The effect is to improve the overall wash performance, particularly on biological stains such as egg, blood and grass stains, and heavily soiled fabrics, since the longer «cool-soak» phase as the water heats up provides the right conditions for the powder and the water temperature to interact, and achieve the best possible results.

6

## ECONOMY BUTTON

By pressing in this pushbutton prior to selecting wash cycle A, you will obtain a reduction of the wash temperature from 95°C to 60°C whilst the duration of the programme will remain practically unchanged.

This will ensure a substantial saving in electricity consumption.

It is advisable to press in this pushbutton particularly when washing strong white fabrics which do not have stubborn stains.

# USE OF CONTROLS

**7**

## **RINSE HOLD BUTTON**

Press this button to leave the water in the wash tub after the wash cycle is completed.

**This works only on mixed fabrics, wool or delicate/synthetic programmes.**

The clothes are left suspended in water after the final rinse to prevent the formation of creases.

Depress the button to drain the water.

The «Rinse Hold» option should not be used when using «Wash'n' Dry».

**8**

## **ON/OFF BUTTON**

By depressing this button the machine starts operating. When it is depressed again, the machine stops. This push button has a child-resistant safety lock. Move the small slider placed on the button to lock it in the «off» position.

**9**

## **OPERATING PILOT LIGHT**

This lights up when the ON/OFF button is depressed and goes out when the button is pressed again.

**10**

## **PROGRAMME CONTROL**

To select the required programme, press the knob to pop it out. Turn the knob clockwise until the marker at the top of the dial coincides with the required programme letter.

Press the knob again if you wish to return it to its original position.

# HOW AND WHEN TO USE THE CONTROLS

## START

After loading the laundry and placing the washing powder or liquid and additives into the appropriate compartments, before starting up the machine check that:

- the appliance is plugged in
- the water supply taps are turned on
- the drain hose is correctly and securely positioned
- the door and the washing powder dispenser drawer are closed.

Depress the required pushbutton(s).

See page 11 for details of operation.

Select the required programme by turning the programme dial **clockwise**.

Set the drying time if you are using the Wash 'n' Dry option.

At this stage, press the ON/OFF button to start the programme up.

The door locked light comes on and the programme starts up.

## STOP

When the programme has finished, the programme dial will be in the «I» position and the machine will automatically stop.

**If you have depressed the «Rinse Hold» button, the water remaining in the wash tub must be drained by pressing again the same button before opening the door.**

Open the door only at the end of the programme when the door locked light goes out.

If necessary, stop the machine by pressing the ON/OFF button again.

At the end of the programme, all the buttons must be reset to the «rest» position (not depressed).

## THE WASHING

### PROGRAMMES

This washing machine has a wide range of programmes for optimum washing of all types of fabrics.

The differences between the programmes are the rotation rhythm of the drum, the washing temperature, the water level, use or not of the spin cycle etc.

Three special programmes are included in this washing machine; «worn once» is for very lightly soiled garments, giving a gentle, cool wash. «Hand rinses» is intended as a special rinse cycle to use after laundry has been washed by hand. «Freshen up» is a single rinse cycle to use for unsoiled laundry that may, for example, need rinsing to remove a stale smell, or to revive badly creased dry laundry.

## DRYING

The dryer part of this machine is a Turbo Condenser Dryer.

During the drying cycle the machine uses a small amount of water.

The clothes are dried by means of a continuous flow of hot air which as it passes through the drum, gradually reduces the moisture in the laundry.

The moisture is then condensed within the machine. The condensed water is then drained away, together with the cooling water, through the drain hose. There is no need to provide special ventilation in the room in which the machine is installed.

The duration of the preset drying time may be shortened or extended during the drying cycle. Do not extend or shorten the drying period within the  -0 minute cycle. During this time both the machine and the laundry are cooling off.

During a power failure it is advisable to remove the laundry from the machine. After a short mains power failure the machine will continue with the selected programme once the power is restored.

# HOW AND WHEN TO USE THE CONTROLS

## IMPORTANT

Only laundry washed in water should be dried in this machine. In particular, the following fabrics should not be loaded into the dryer:

Clothes which were dry-cleaned or cleaned with chemical solvents;

Woollens or mixed woollens which will shrink with heat;

Extremely delicate fabrics such as silk and delicate synthetics;

Sponge, rubber and similar items;

Fibre glass items.

Fabrics tending to fray.

## DRYING TIMES

The drying times of all fabrics will depend on the extent to which they have been spun as well as the fabric characteristics. The higher the spin speed the shorter the drying time.

To alleviate creasing, care should be taken not to overdry clothes. All clothes should be removed from the drum as quickly as possible after completion of a drying cycle.

## IMPORTANT

Polycottons of less than 70% cotton should NOT be dried using «High Temperature drying (Red Section).

Only polycottons with more than 70% cotton content should be dried using programme F



















If you are not sure of the cotton content use «Low Temperature» drying (Blue Section).

## WASH 'N' DRY

It is possible to programme the machine to run automatically from the wash programme through to the drying programme without pausing. In this case, the wash load must be no more than 2.25kg (5 lb) for cottons and a maximum of 1.5kg (2.2 lb) for synthetics. This is possible on all programmes except the Wool, Silk and Delicates (K-L-M-N programmes).

The familiar wash code symbols which are found on the care labels in most clothes will gradually disappear and a new set of codes will be introduced. This change is due to changes in fabrics and detergents and because

people are tending to use fewer programmes and mix fabrics in one load. The change will bring the codes into line with the labelling used in the rest of Europe.

Old Symbol	New Symbol	Wash Action	Fabric
		Normal (Maximum)	White Cotton or Linen without Special Finishes
		Normal (Maximum)	Cotton, Linen or Viscose without Special Finishes Colourfast at 60° C.
	No longer used. White Nylon, Polyester/Cotton mixtures now included in		
		Reduced (Medium)	Nylon, Polyester/Cotton, Viscose with Special Finishes: Cotton/Acrylic Mix.
		Normal (Maximum)	Cotton, Linen or Viscose Colourfast at 40°C but not 60°C.
		Reduced (Medium)	Acrylics, Acetate, Triacetate, Wool mixes, Polyester/wool blends.
		Much Reduced (Minimum)	Wool, wool mixes. Silks.
	No longer used. Silk now included in		 ;
	printed acetate included in		 .
	No longer used.		











The new symbols have been used on the Programme Guide of this machine, and are listed in the Programme Charts on page 14 and 15.

The new wash symbols will also appear on the side of Washing Powder packets.

# PROGRAMMES FOR COTTON AND LINEN

## Washing programmes

Recommended load: max. 4.5 kg (10 lb)

PROGRAMME	DEGREE OF SOIL	COMPARTMENTS TO USE (☉ if required)	PROGRAMME DIAL POSITION	DESCRIPTION
 95	WHITES with prewash Heavy soil		<b>R</b>	Prewash at 40°C Wash at 95°C 5 rinses Spin
 95	BOILWASH WHITES Normal soil		<b>A</b>	Wash at 95°C 5 rinses Spin
 60	WHITES Light soil		<b>B</b>	Wash at 60°C 5 rinses Spin
 60	FAST COLOURED Normal soil		<b>B</b>	Wash at 60°C 5 rinses Spin
 40	NON - FAST COLOURED Normal soil		<b>C</b>	Wash at 40°C 5 rinses Spin
	LONG SPIN		<b>D</b>	Long spin approx. 6 min. Always preceded by a low-speed draining phase
	SHORT SPIN		<b>H</b>	Short spin approx. 2 min. Always preceded by a low-speed draining phase

Water filling: 40°/50°C programmes - cold water filling; 60°C programmes - hot and cold filling  
95°C programmes - hot water filling only, unless the heavy soil button is used.

## Wash 'n' Dry Programmes

Recommended load: max. 2.25 kg (5 lb) drying only.

Do NOT use ball dispensers on Wash 'n' Dry programmes. The automatic drying can be used on programme R, A, B, C, D and H by depressing the Wash 'n' Dry button and setting the drying time.

## Energetic drying programme (0-80 mins - indicated by continuous line (High Temp.))

Fabric type/ Spin speed	Programme	Quantity	Drying time	
			Iron dry	Cupboard-dry
Cotton and linen (Long spin at 1200 rpm)	<b>F</b>	2.25 Kg (5 lb)	40-50 mins	60-70 mins
		2.0 Kg (4 lb)	35-45 mins	55-65 mins
		1.5 Kg (3 lb)	30-40 mins	40-50 mins
		1.0 Kg (2 lb)	25-30 mins	35-40 mins

The drying times indicated in this table are for drying cotton towels. By varying the composition of the load the drying times indicated will vary.











# PROGRAMMES FOR SYNTHETICS, MIXED FABRICS

## SILK AND WOOL

### Washing programmes

Recommended load: max. 2 kg (4.5 lb); wool max. 1 kg (2.2 lb) washing only.

(\*) If the «Rinse Hold» button has been depressed the machine will not proceed to the spin as indicated, until the button has been released, but will have water left in the drum.

PROGRAMME	DEGREE OF SOIL	COMPARTMENTS TO USE (☼ if required)	PROGRAMME DIAL POSITION	DESCRIPTION
 <b>MIXED FABRICS</b>	Normal soil		<b>G</b>	Wash at 50°C 3 rinses Short spin (*)
 <b>DELICATES/ SYNTHETICS</b>	Normal soil		<b>K</b>	Wash at 40°C 3 rinses Short spin (*) Wash'n' dry option not available
 <b>WOOL</b>	Normal soil		<b>L</b>	Wash at 40°C 3 rinses Short spin (*) Wash'n' dry option not available
<b>WORN ONCE</b>	Light soil		<b>M</b>	Wash at 30°C 3 rinses Short spin (*) Wash'n' dry option not available
<b>HAND RINSES</b>			<b>N</b>	3 rinses with additive if required Short spin (*) Wash'n' dry option not available
<b>FRESHEN UP</b>			<b>P</b>	1 rinse with additive if required Short spin (*) Wash'n' dry option not available
<b>DRAIN</b>			<b>Q</b>	Draining of water

### Wash 'n' Dry Programmes

Automatic drying can be used on programme G, by depressing the Wash 'n' Dry button and setting the drying time.

### Delicate Drying Programme (0-80 mins - indicated by dotted line (Low Temp)).

Fabric type/ Spin speed	Programme	Quantity	Drying time	
			Iron dry	Cupboard-dry
Synthetics (Short spin at 850 rpm)	<b>J</b>	1.5 Kg (3 lb)	—	75-80 mins
		1.0 Kg (2 lb)	—	55-60 mins
		0.5 Kg (1 lb)	—	35-40 mins

The drying times given in this table are just an indication of the average drying times.

# USE OF DETERGENT AND ADDITIVES

## CHOOSING THE RIGHT

### WASHING POWDER

Always use a low lather powder. This is important as too much lather prevents the articles from being properly cleansed and you may damage the machine. **Ariel Automatic** is specially designed to complement the cleaning action of the machine.

## USE OF WASHING

### POWDER

The washing powder should be placed in the appropriate compartments in the washing powder dispenser drawer before starting the programme.

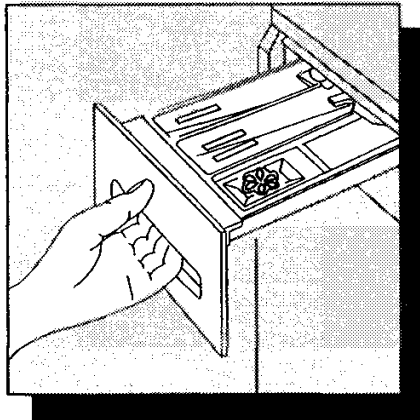

The compartment marked with the symbol **U** is for the prewash powder (if required by the programme).

The compartment marked with the symbol **W** is for the main wash powder.

## HOW MUCH

### DETERGENT?

Your washing machine has a unique water circulation system which runs continuously. This means that it uses detergent sparingly.

Initially you are advised to use less than the quantity specified by the detergent manufacturer.

Subsequently it is worth experimenting to see if your laundry comes out clean with smaller quantities.

Powder residue left on the clothes at the end of a wash indicates the use of too much powder. If the drum is only half-full, you can obviously use less detergent.

## USE OF LIQUID

### ADDITIVES

Any liquid additives for softening or starching the laundry must be poured into the appropriate compartment of the washing powder dispenser drawer before starting the programme.

The compartment marked with the symbol  is for softeners or starching agents.

Concentrated additives **MUST** be diluted before pouring in the compartment.

Never exceed the **MAX** level.

## USE OF LIQUID

### DETERGENT

Suitable liquid detergent such as **Ariel** can be used instead of washing powder.

In this case a programme without prewash must be selected.

Pour the liquid detergent into the compartment  in the dispenser drawer immediately before starting the programme.

If the detergent has its own dispenser ball, this should be used according to the manufacturer's instructions.

## NOTE

Once the dispenser is filled, close it by pushing it in gently. This is particularly important if you are using fabric conditioner because if the drawer is slammed it will cause the conditioner to enter the machine prematurely.

## IMPORTANT

Before the drying cycle always remove re-usable plastic detergent dispensers designed to be placed inside the drum with the clothes as the plastic used is not designed to withstand the heat of the drying cycle.

# WASHING 4 KG OF WHITE COTTON AT 95°C

Suppose you have 4 kg of normally soiled laundry to wash. It is white cotton and resistant to high temperature washing.

## 1 LOAD THE LAUNDRY



Open the door by pulling the catch outward. Load the items to be washed one at a time and close the door.

## 2 MEASURE OUT THE WASHING POWDER

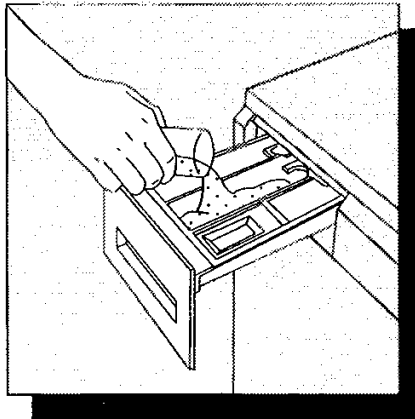

Pour the washing powder into compartment **U**, the main wash compartment.

## 3 MEASURE OUT THE ADDITIVES

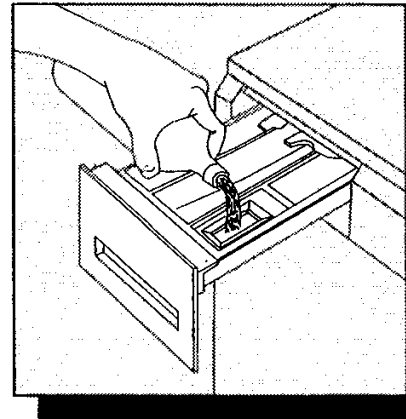

Pour the softener, if required, into the compartment marked **⊗**; do not exceed the MAX level.  
Close the drawer gently.

# WASHING 4 KG OF WHITE COTTON AT 95°C

4

## SELECT THE PROGRAMME

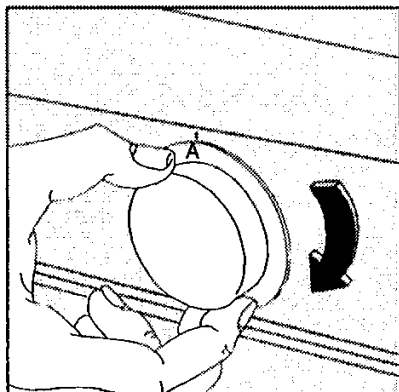

Turn the programme dial **clockwise** until letter **A** on the dial coincides with the grey marker line.

5

## START UP

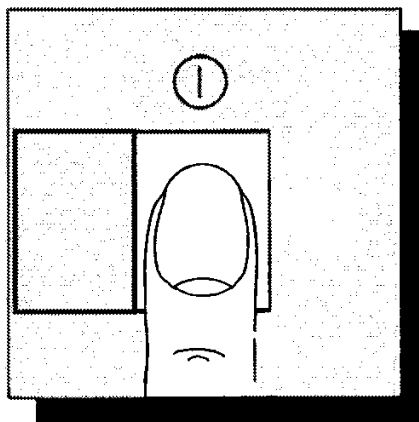

Check that:

- the appliance is plugged in
- the water taps are on
- the drain hose is correctly positioned

Then push the ON/OFF-button ① .

The pilot light will come on and the machine will start.

6

## AT THE END OF THE PROGRAMME

The machine automatically stops.

The door is controlled by a safety device which releases 1 - 2 minutes after the end of the programme.

Open the door only when the door locked light is off.

Push the ON/OFF-button ① again and the pilot light will go out.

When the programme has finished you are advised to unplug the appliance and turn off the water taps.

# WASHING 2 KG OF SYNTHETIC FABRICS AT 40°C

Suppose you have 2 kg of synthetic fabric laundry to wash. They are rather delicate fabrics and should not be washed at a high temperature.

**1**

**LOAD**

**THE LAUNDRY**

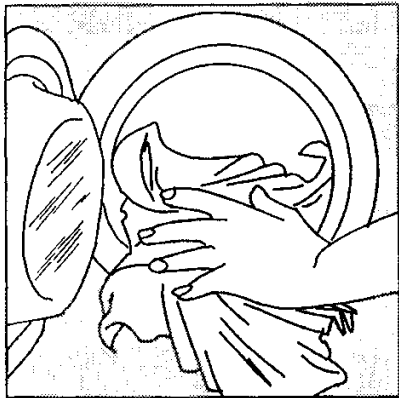

Open the door by pulling the catch outward. Load the items to be washed one at a time and close the door.

**2**

**MEASURE OUT**

**THE WASHING POWDER**

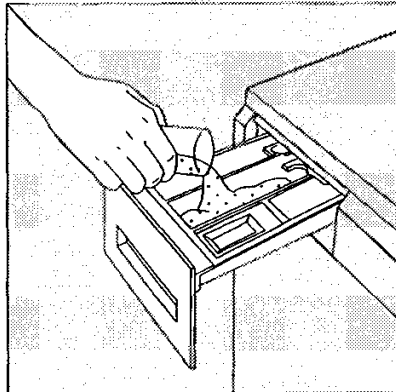

Pour the washing powder into compartment **U**, the main wash compartment.

**3**

**MEASURE OUT**

**THE ADDITIVES**

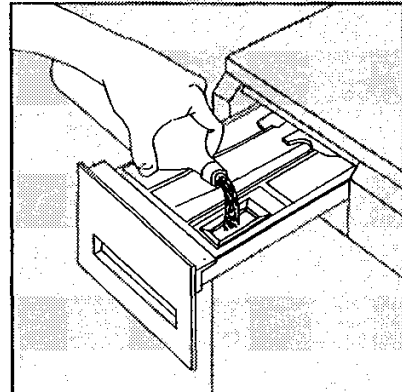

Pour the softener, if required, into the compartment marked **⊗**; do not exceed the MAX level.

Close the drawer gently.

# WASHING 2 KG OF SYNTHETIC FABRICS AT 40°C

4

## SELECT THE PROGRAMME

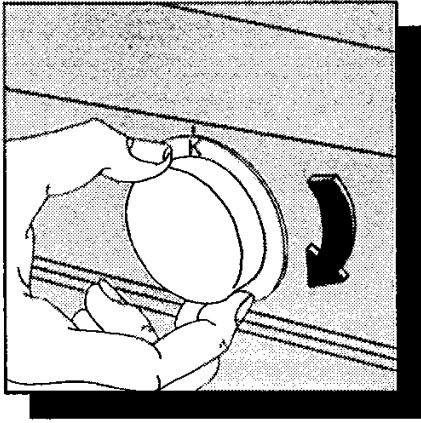

Turn the programme dial **clockwise** until letter **K** on the dial coincides with the grey marker line.

5

## START UP

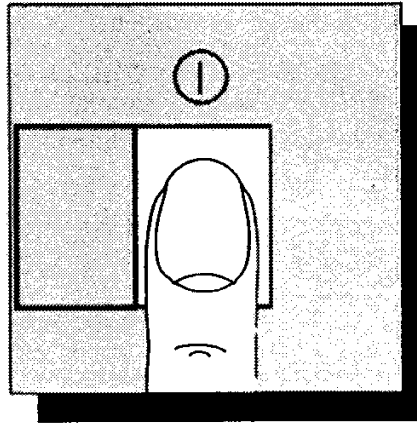

Check that:

- the appliance is plugged in
- the water taps are on
- the drain hose is correctly positioned

Then push the ON/OFF-button **I**.

The pilot light will come on and the machine will start.

6

## AT THE END OF THE PROGRAMME

The machine automatically stops.

The door is controlled by a safety device which releases 1 - 2 minutes after the end of the programme.

Open the door only when the door locked light is off.

Push the ON/OFF-button **I** again and the pilot light will go out.

When the programme has finished you are advised to unplug the appliance and turn off the water taps.

# DRYING 2.25 KG (5 LB) OF COTTON

You have for example just machine-washed and spun at 1200 rpm 4.5 kg (10 lb) of laundry.

They are cotton fabrics of medium weight which you want to iron as soon as they are dry.

Switch off the machine. Then remove the laundry from the appliance and divide the items to obtain two loads of approx. 2.25 kg (5 lb) each.

**1**

## LOAD THE LAUNDRY

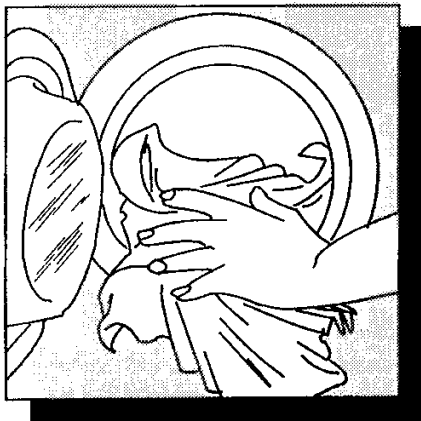

Load the items you have to dry one at a time, shaking them out loosely and close the door.

**2**

## SELECT THE PROGRAMME

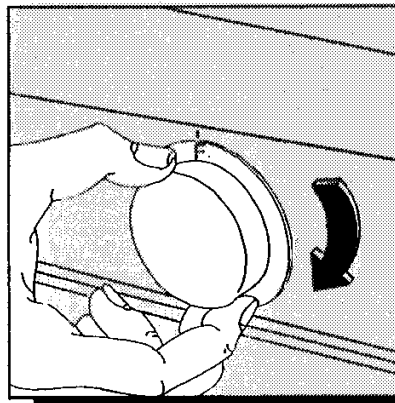

Turn the programme dial clockwise until letter F on the dial coincides with the grey marker line.

**3**

## SELECT THE TIME

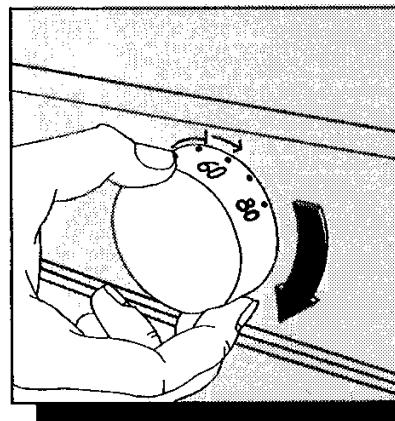



Following indications given in the drying times chart, turn the selector dial clockwise on the 50 mins setting of the red section (High Temperature Range).

**4**

## START THE MACHINE

Switch on the ON-OFF switch.

The pilot lights  and  illuminate and the machine will start to work.

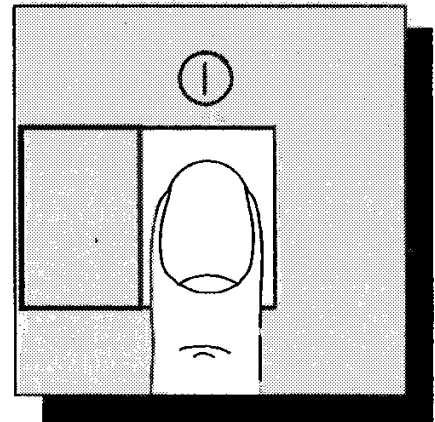

**5**

## STOPPING THE MACHINE

At the end of the programme the machine stops automatically and the Dryer Indicator Light  will go out.

Depress the ON-OFF pushbutton, the light  goes out.

If the laundry is still too damp, select a further brief drying time, bearing in mind that during the last 12 minutes the appliance carries out a cooling and anti-crease phase.



# WASHING 2 KG OF SYNTHETIC FABRICS AT 40°C

4

## SELECT THE PROGRAMME

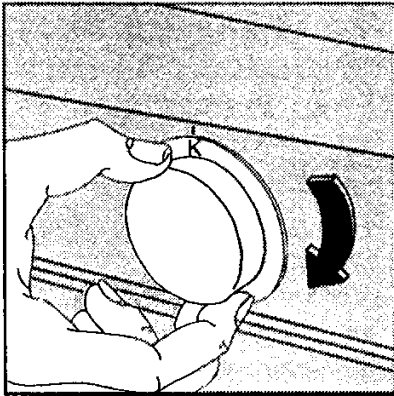

Turn the programme dial **clockwise** until letter **K** on the dial coincides with the grey marker line.

5

## START UP

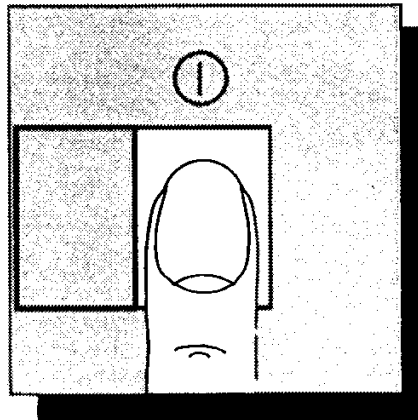

Check that:

- the appliance is plugged in
- the water taps are on
- the drain hose is correctly positioned

Then push the ON/OFF-button ①.

The pilot light will come on and the machine will start.

6

## AT THE END OF THE PROGRAMME

The machine automatically stops.

The door is controlled by a safety device which releases 1 - 2 minutes after the end of the programme.

Open the door only when the door locked light is off.

Push the ON/OFF-button ① again and the pilot light will go out.

When the programme has finished you are advised to unplug the appliance and turn off the water taps.

# AUTODRYING 1 KG (2.2 LB) OF MIXED FABRICS

You intend to wash and dry automatically 1 kg (2.2lb) of mixed fabrics which do not need ironing.

You should not press the «Rinse Hold» button.

Proceed as follows:

1. Load the laundry.
2. Add the washing powder and additive (if required).

**3**

## SELECT THE PROGRAMME

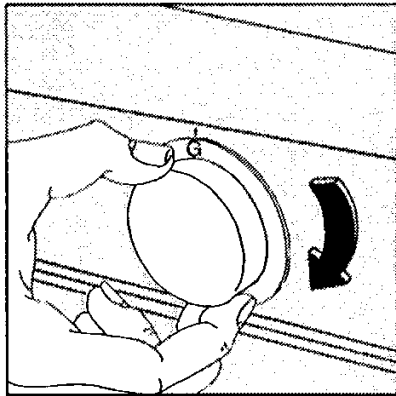

Turn the programme dial **clockwise** until letter G on the dial coincides with the grey marker line.

**4**

## SELECT THE TIME

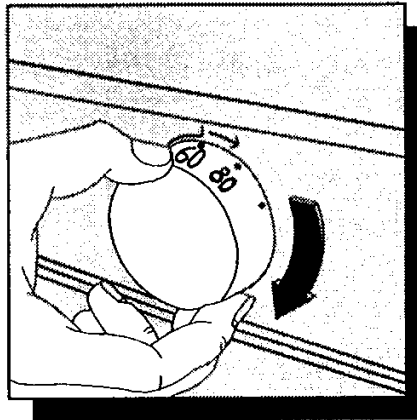

Following indications given in the drying times chart, turn the selector dial clockwise on the 60 mins setting of the blue section (Low Temperature Range).

**5**

## SELECT AUTO DRYING



Depress the Wash' n' dry push button.

**6**

## START THE MACHINE

Switch on the ON-OFF switch.

The pilot light  illuminates and the machine will start to work.

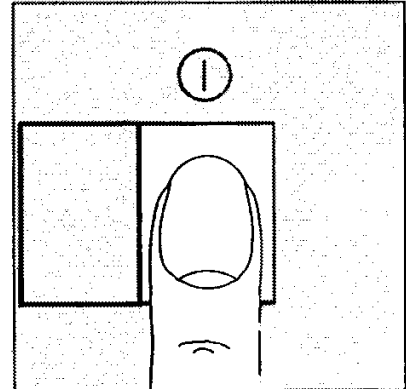

**7**

## STOPPING THE MACHINE

At the end of the programme the machine stops automatically and the Dryer Indicator Light  will go out.

Depress the ON-OFF push button, the light  goes out.

If the laundry is still too damp, select a further brief drying time, bearing in mind that during the last 12 minutes the appliance carries out a cooling and anti-crease phase.

# WASHING HINTS AND DRYING

- Do not overload the machine. Weigh the laundry the first few times you use the appliance.

The average weights of the most common items are listed below as a guide:

1000 g = 1 kg

sheet	700-1000 g
pillow case	100- 200 g
tablecloth	400- 500 g
serviette	50- 100 g
tea towel	70- 120 g
linen hand towel	100- 150 g
towelling hand towel	150- 250 g
towelling bath towel	700-1000 g
bath robe	1000-1500 g
man's shirt	200- 300 g
apron	150- 200 g

- Load the laundry loosely alternating large items with small ones.

- Sort the laundry according to the type of fabric, colour-fastness and how dirty it is.

- Avoid washing un-hemmed or torn items as they may unravel.

- Before washing, empty all pockets of small objects which may have been left inside (coins, keys, screws etc.), as these could damage the drain pump.

- When washing curtains, remove the hooks.

- Close poppers and zips and fasten loose buttons.

- It is essential to wash new coloured items separately when washing for the first time.

- When washing fabrics requiring different wash temperatures together, always select the lowest temperature.

- White items should not be washed with coloured items.

- Very small items (handkerchiefs, ribbons, socks etc.) should be washed in a washing bag or a pillow case.

- Use a good quality detergent suitable for automatic washing machines.

- Use the correct quantities of detergent.

- For wool, use gentle detergents only in small quantities.

- Bleach is very corrosive; it should be used with care and kept out of reach of children.

- Some stains such as fruit, wine, grass, rust etc. are difficult to remove and should be treated before washing with specific products which can be found in most household shops. In some cases it may help to soak the stain before washing with a special pre-soak product or biological detergent.

- Only wool marked «Pure New Wool - washable, preshrunk» can be washed in the machine using the wool programme; other types of wool should be washed by hand or dry cleaned.

- When drying always load well spun laundry. The higher the spin speed the lower is electric energy consumption and the shorter is the drying time.

- Do not leave the damp laundry load in a heap too long before drying.

- Avoid drying dark clothes with light coloured fluffy items such as towels as these can attract the fluff.

- If you overdry the laundry, besides wasting energy, any subsequent ironing may become more difficult because the fabric could be heavily crumpled.

- Remove the laundry when the appliance has finished drying.

- To avoid a static charge when drying is completed, use either a fabric softener when you are washing the laundry or a fabric conditioner specifically for tumble dryers.

- For drying, follow the indications given on the manufacturers' labels.

 Drying at high temperature

 Drying at reduced temperature

 Do not tumble dry

- Once you have finished using the machine, you are advised to unplug it and turn off the water tap.

# MAINTENANCE

Successful washing and smooth running of your machine depend on a series of routine maintenance operations which should be carried out from time to time.

## IMPORTANT

*Before carrying out any maintenance or cleaning you **MUST** disconnect the appliance from the electricity supply.*

## DECALCIFICATION

The water we normally use contains lime. From time to time, and more often for hard water, it is a good idea to use a water softening powder in the machine. Add this powder according to the manufacturer's instructions. This will prevent the formation of lime deposits.

## AFTER EACH

## WASH

Leave the door open for a while.

This helps prevent mould and stagnant smells forming inside the appliance.

## EXTERNAL CLEANING

Use soap and water only and then dry thoroughly.

## CLEANING

### THE DRAWER

From time to time the washing powder and additive dispenser drawer should be cleaned.

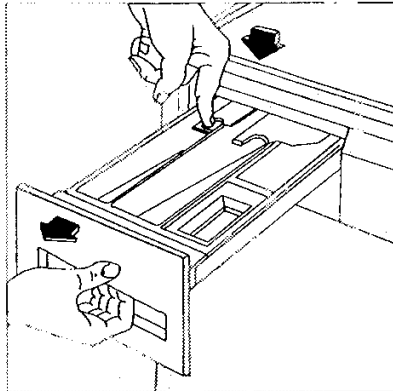

Remove the drawer and flush out under a tap.

The upper part of the additives compartment can be removed for easier cleaning.

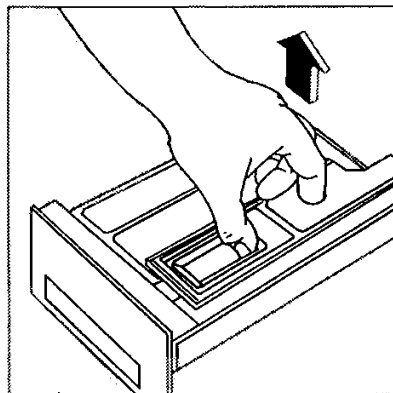

## CLEANING

### THE DRAWER RECESS

Having removed the drawer, use a small brush to clean the recess ensuring that all washing powder residue is removed from the upper part of the recess. Replace the drawer and run programme C for a few minutes and then the drain cycle Q to clear any residues.

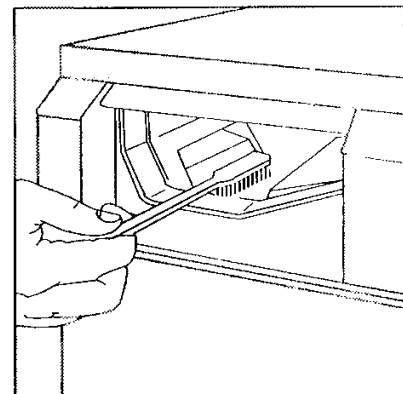

## THE DANGERS OF

### FREEZING

If the machine is exposed to temperatures below 0°C, certain precautions should be taken.

- Turn off the water taps and unscrew the inlet hoses.
- Select a wash programme and run for a few seconds.
- Unhook the drain hose from the rear support and position the end in a bowl. Run the draining programme for a few seconds.
- When you intend to start the machine up again, make sure that the room temperature is above 0°C.

# CLEANING THE FILTER

## THE WATER

### DRAIN FILTER

A clean filter is important for correct functioning of the machine, and should therefore be cleaned after every wash.

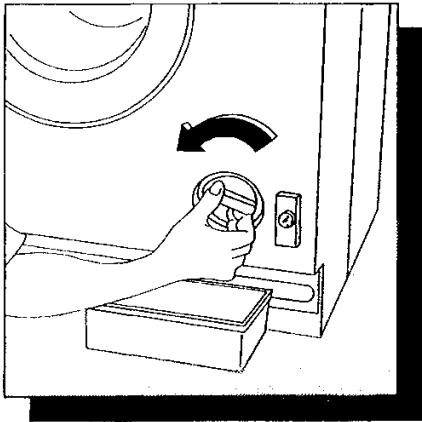

Place a container underneath to catch any spillage.

Unscrew the filter.

If the filter is blocked and the machine is unable to drain you will need to drain the water from the machine at this stage.

To do this, unhook the drain hose from the standpipe or sink and hold the end of the hose over a bowl on the floor. The water should drain by gravity into the bowl. When the bowl is full, hook the hose back up and empty the bowl. Repeat the procedure until the water stops flowing out.

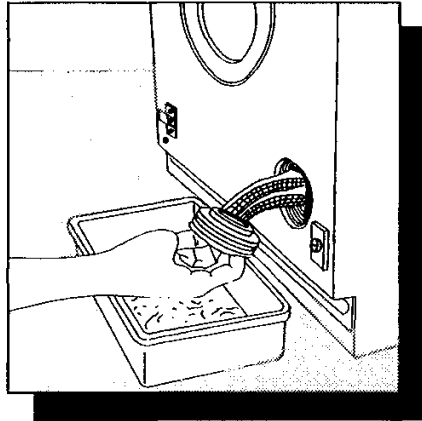

Remove the filter.

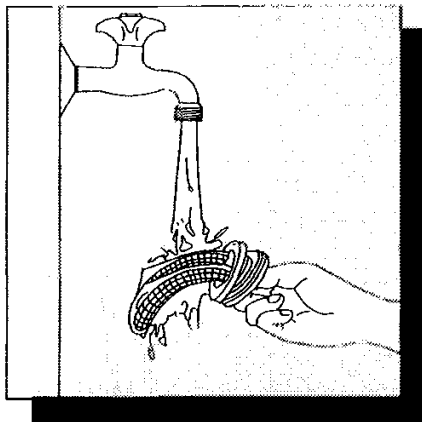

Clean carefully under a fast-running tap.

## WARNING

When the appliance is in use and depending on the programme selected there can be hot water in the filter. Never remove the filter during a wash cycle, always wait until the appliance has finished the cycle, and is empty. When replacing the filter, ensure it is securely retightened. This will prevent leaks and also stop young children being able to remove the filter.

## THE WATER

### INLET FILTERS

If your water is very hard or contains traces of lime deposit, the water inlet filters may become clogged.

It is therefore a good idea to clean them from time to time.

Turn off the water taps. Unscrew the water inlet hoses.

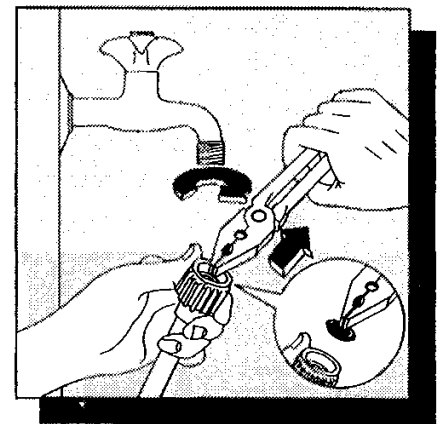

Remove and clean the filters using a hard bristle brush.

Replace the filters and tighten up the inlet hoses.

# DOOR REVERSAL & BUILDING-UNDER

## PREPARATION AND ASSEMBLY OF THE DOOR

It is possible to change the door opening side so as to match it perfectly with the rest of the kitchen furniture.

The machine is originally pre-arranged for assembly of a door with right side opening.

In this case it is sufficient to screw-in on the door the two hinges (1) and the counter-magnet (5) in the right position.

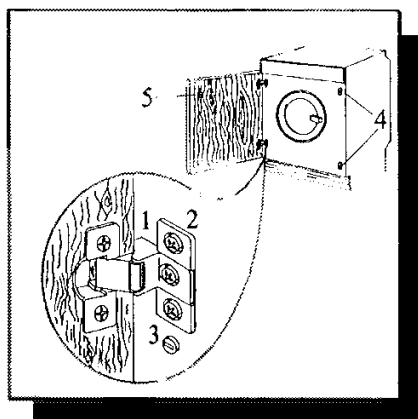

## CABINET'S DOOR

The dimensions of the cabinet's door should be:

width 595+3 mm  
thickness 16 to 22 mm

The height (C) cannot be given, since it depends on the height of the adjacent furniture, e.g. height of the kick plate of the kitchen unit.

## HINGES

To mount the hinges on the door it is necessary to drill 2 holes (dia. 35 mm, depth 14 mm) on the door's inner side.

The distance between the holes must be 416 mm.

The dimension (B) (from upper edge of the door to the center of the hole) cannot be given, since it depends on the adjacent cabinets' dimensions.

The required dimensions are given in the picture.

The hinges will be fixed to the door by means of the 4x16 mm screws.

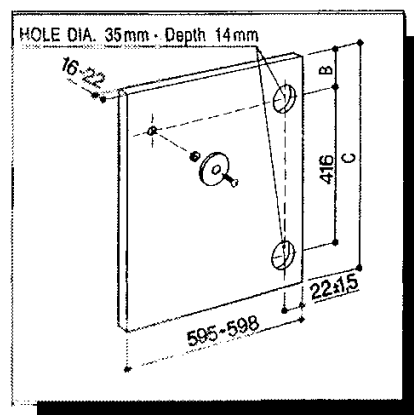

## MOUNTING THE DOOR

Now fix the hinges to the machine by means of the M 5x8 mm screws. To compensate for possible uneven thickness of the door the hinges can be adjusted horizontally.

To align the door perfectly it may sometimes be necessary to adjust the height of the plates (2). This can be done by loosening the plastic screw (3).

## COUNTER-MAGNET (5)

The door is kept closed by a magnetic closure.

To enable the closure to operate a counter-magnet must be screwed into the door inner side (steel disk with rubber ring).

Its position must correspond with the magnet on the appliance (see picture).

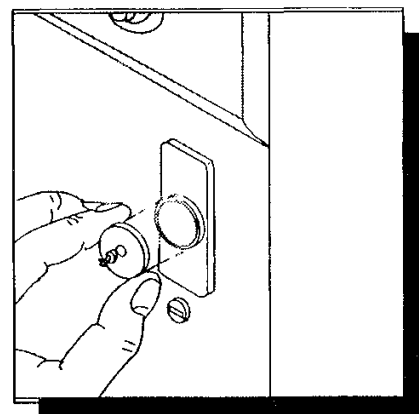

## CHANGE OF DOOR OPENING DIRECTION

Should a change of the opening direction to the left side be required, operate as follows:

- Unscrew the door magnet (4) and the rubber buffer (4) and take out the plastic inserts.
- Fit the hinge fastening plates (2) on the right side.
- Fit the magnet, the rubber buffer and the plastic inserts on the left side.

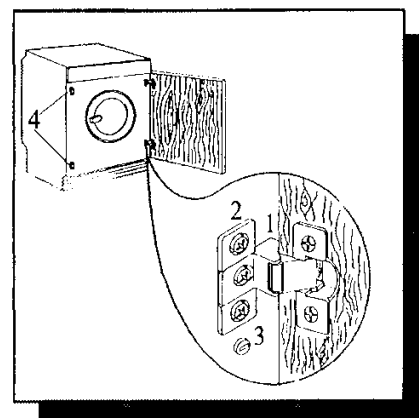

# DOOR REVERSAL & BUILDING-UNDER

## INSTRUCTIONS FOR BUILDING IN UNDER A COUNTER

This washing machine is designed to be built into a kitchen unit due to its standard dimensions.

The machine should be inserted into a recess having the dimensions shown in the picture, making sure that the fill and drain hoses are not bent or kinked in such a way as to obstruct the normal water flow.

As for water & electricity connection, please follow the rules given in this operator's handbook.

Furthermore, we strongly recommend that the water & electricity supply cut off controls remain easily accessible.

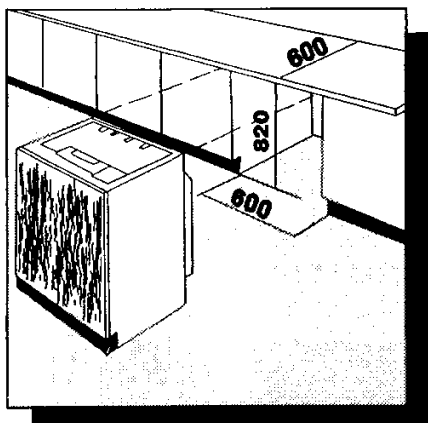

# SERVICING

Certain problems are due to lack of simple maintenance or oversights and can be solved easily without having to call the Servicing Department.

## ■ PROBLEM

■ THE MACHINE DOES NOT START UP  
(with pilot light off)

(with pilot light on)

## ● CAUSE

- The On-Off button is not pressed
- The door is not closed properly
- The appliance is not plugged in
- There is no electric supply from the wall socket
- The programme selector is not correctly positioned
- No water is entering the machine

## ▶ SOLUTION

- ▶ Press the On-Off button
- ▶ Close the door
- ▶ Plug the appliance in
- ▶ Check the fuse
- ▶ Consult a qualified electrician
- ▶ Turn the programme selector to the required programme
- ▶ See solutions to the problem: THE MACHINE DOES NOT FILL

■ THE MACHINE DOES NOT FILL

- The water tap is not on
- The water supply has been cut off
- The inlet hose is bent
- The water pressure is too low
- The water inlet filter is clogged

- ▶ Turn the tap on
- ▶ Wait until the water supply is restored
- ▶ Straighten the bend out
- ▶ If this occurs often, consult a qualified plumber
- ▶ Clean the filter (see page 28)

■ THE MACHINE EMPTIES AS IT FILLS

- The end of the drain hose is too low
- The end of the drain hose is submerged in water
- Drain pipe without vent-hole

- ▶ Position the drain hose at the correct height (between 60 and 90 cm)
- ▶ The end of the drain hose must NOT be submerged
- ▶ Consult a qualified plumber

■ THE MACHINE DOES NOT DRAIN OR SPIN

- You have pressed the «Rinse Hold» button
- The drain filter is clogged
- The drain hose is bent
- The drainage system pipes are blocked
- The drain hose extension is incorrect

- ▶ Press this button again to drain the water
- ▶ Clean the filter. Before doing this see page 28
- ▶ Straighten the hose out
- ▶ Consult a qualified plumber
- ▶ Consult a qualified plumber



## ■ PROBLEM

### ■ THE MACHINE LEAKS OR OVERFLOWS

## ● CAUSE

- Too much washing powder
- Unsuitable washing powder
- The inlet hose ring is loose
- The detergent dispenser drawer or recess are clogged
- The end of the drain hose is not securely positioned

## ▶ SOLUTION

- ▶ Reduce the quantities of washing powder
- ▶ Only use washing powder suitable for automatic machines
- ▶ Tighten the ring (see page 8)
- ▶ Clean the drawer and recess (see page 27)
- ▶ Position the drain hose correctly

### ■ THE MACHINE VIBRATES OR IS NOISY

- The internal packing has not been removed
- The machine is not level
- The machine is in contact with the wall or furniture
- The washing load is badly distributed
- The machine is overloaded

- ▶ Remove internal packing (see p. 7)
- ▶ Adjust the feet (see page 10)
- ▶ Move the machine; it should rest freely on its feet
- ▶ Remember to shake out large items (e.g. sheets) when loading
- ▶ Run the draining programme (Q), reduce the load and continue

### ■ THE MACHINE DOES NOT DRY

- A drying programme has not been selected
- The cold water tap is not on
- The drainage filter is clogged
- The machine is overloaded
- The drying time is not adequate

- ▶ Select a drying programme
- ▶ Turn the tap on
- ▶ Clean the filter (see page 28)
- ▶ Reduce the load
- ▶ Refer to the drying time table and set the correct time (see pages 16-17)

## ■ PROBLEM

### ■ THE DOOR DOES NOT OPEN

## ● CAUSE

- The safety device has locked it (door locked light on)
- Water in the wash tub

## ▶ SOLUTION

- ▶ Wait 1 - 2 minutes after the end of the programme before opening the door (door locked light off)
- ▶ Drain the water by running the draining programme (Q)

If, after the above checks, there is still a fault, call your nearest Zanussi Service Force Centre, whose address and telephone number can be found on the following pages.

Please make sure you give the model and serial number of the appliance. This information can be found on the rating plate (see picture), or on the guarantee certificate.

Original spare parts can be purchased from Zanussi Service Force Centres.

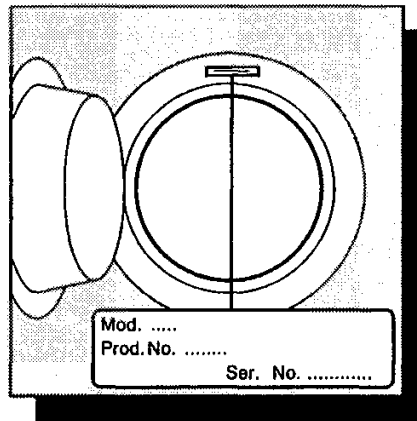

**In-guarantee customers should ensure that the above checks have been made as the engineer will make a charge if the fault is not a mechanical or electrical breakdown.**

Please note that proof of purchase is required for any in-guarantee service calls.

**How to find the telephone number of  
your  
Zanussi Service Force  
listed in this leaflet**

Zanussi Service areas are allocated by postcodes which are listed in alphabetical order for easy reference.

1. Look for the two letters of your address postcode in the far left 'Postcode' column.
2. Match up the number of your postcode against the number listed in the 'Postcode Numbers' column.
3. Look across the column to the Service Force Key Number for your area. Turn to the last page of this directory for the address and telephone number to contact for service which is listed against your key number.

If you are unsure of your postcode, the main towns and cities are listed in alphabetical order for easy reference.

Additionally, your local Zanussi Service Force Centre telephone number is listed under 'Z' in your telephone directory.

The Customer Care Department at Zanussi House, Hambridge Road, Newbury, RG14 5EP, Tel: 0635 521313, will be happy to help you with any queries or difficulties.



Post-code Letter	Town	Post-code Number	Service Force Key Number	Post-code Letter	Town	Post-code Number	Service Force Key Number
AB	Aberdeen	1-5, 22-23, 30-38	1	DE	Derby	11-12	18
AB		41-45, 51-56	1	DE	Derby	4-5, 55	33
AL	St Albans	1-10	2	DG	Dumfries	1-7, 10-12, 14	34
A	Brecon	45	3	DG		8-9	34
BA	Bath	1-5, 11-15	4	DG	Dumfries	13	35
BA		7-10,20-22	5	DH	Durham	1-9	37
BA		6,16	6	DL	Darlington	1-17	37
BB	Blackburn	1-12	7	DN	Doncaster	1-7, 10-12, 22	33
BD	Bradford	1-23	8	DN		14	38
BD		24	7	DN	Doncaster	8-9, 15-21, 31-40	39
BH	Bournemouth	1-25	9	<b>SUB POSTCODE DIVISION</b>			
BL	Bury	0-9	11	DN	Gainsborough		
BN	Brighton	1-15,	12		<b>South</b>	21-1, 21-2, 21-5	40
BN		20-27	12	DN	Gainsborough		
BN		16-18	13		<b>North</b>	21-3, 21-4	39
BR	Bromley	1-8	14	DT	Dorchester	1-5, 10-11	9
BS	Bristol	1-28, 88-89	15	DT		6-9	5
BT	Belfast	1-82	16	<b>SUB POSTCODE DIVISION</b>			
B	Birmingham	1-21, 25-33,	17	DT	Bridport East	6-3, 6-4	5
B		38, 40, 45, 47-48,	17	DT	Bridport West	6-5, 6-6	5
B		60-71, 80, 90-94,					
B		97-98	17	DY	Dudley	1-6, 8-9	17
B	Birmingham	23-24, 34-37,	18	DY		7, 10-14	41
B		42-44, 46, 72-	18	EC	London	All EC Codes	28
B		79	18	EH	Edinburgh	1-42, 46, 52-54	42
B	Birmingham	49-50,	20	EH		43-45	35
B		96	19	EH	Edinburgh	47-49, 51, 55	43
B	Birmingham	95	20	EN	Enfield	1-11	28
CA	Carlisle	1-28	21	EX	Exeter	1-17, 20	45
CB	Cambridge	1-8	22	EX		18-23, 31-39	46
CB		9-11	23	E	London	All East Codes	28
CF	Cardiff	1-8, 31-48	3	FK	Falkirk	1-4	43
CH	Chester	1-4	24	FK		10-14, 18-19	32
CH		5-7	25	FK	Falkirk	5-9, 15-17	47
CH		8	26	FK		20-21	31
CM	Chelmsford	0-6, 8-9, 11-15	27	FY	Fleetwood	0-8	7
CM		7	23	GCI	Guernsey		48
CM	Chelmsford	16-24	28	GL	Gloucester	1-19,	49
CO	Colchester	1-16	23	GL		50-56	49
CR	Croyden	0-9	29	GL		9	15
CT	Canterbury	1-21	36	GL		20	19
CV	Coventry	1-8, 10-12, 21-23,	20	GU	Guildford	1-24, 26, 34-35	50
CV		9, 13	18	GU		25	51
CV	Coventry	31-37	20	GU	Guildford	27-33	13
CV		36	19	G	Glasgow	1-5, 11-15, 20-23,	47
CW	Crewe	1-12	30	G		31-34, 40-46, 51-	47
DA	Dartford	1-18	29	G	Glasgow	53, 58, 60-69, 73,	47
DD	Dundee	1-5, 7-11	31	G		76-78, 81-84	47
DD		6	32	G	Glasgow	71-72, 74-75	43
DE	Derby	1-3, 6-7, 13-15	10				

Post-code Letter	Town	Post-code Number	Service Force Key Number	Post-code Letter	Town	Post-code Number	Service Force Key Number
HA	Harrow	0-9	2	MK	Milton Keynes	1-17, 19, 40-46	22
HD	Huddersfield	1-8	8	MK		18	65
HG	Harrogate	1-5	8	ML	Motherwell	1-12	43
HP	Hemel	1-3	2	M	Manchester	1-35, 60	11
HP	Hempstead	4-23	53	NE	Newcastle -on-Tyne	1-49, 61-70, 88	66
HR	Hereford	1-2, 4, 6-9	49	NE		98-99	66
HR		3, 5	54	NE		71	35
HU	Hull	1-20, 55	38	NE	Nottingham	1-14	10
HX	Halifax	1-7	8	NG	Nottingham	15-22, 25	33
IG	Ilford	1-11	28	NG	Nottingham	23-24	40
IOM	Isle of Man		55	NG	Nottingham	31-34	64
IP	Ipswich	1-15, 30-31	56	NG			
IP		16-27	57	NN	Northampton	1-7, 11-12	67
IP	Ipswich	28-29, 32-33	22	NN		8-10, 14-18	22
IV	Inverness	1-24, 26, 30-36,	58	NN	Northampton	13	65
IV		40-49, 51-56	58	NP	Newport	1-9, 44	3
IV	Inverness	25, 27-28	59	NR	Norwich	1-35	57
JCI	Jersey		60	NW	London	All NW Codes	52
KA	Kilmarnock	1-26, 28-30	43			Except 2,4,7,9,10	
KA		27	61	NW	London	2,4,7,9,10	2
KT	Kingston-on-Thames	1-23	51	N	London	All N Codes	28
KT		24	50	OL	Oldham	1-12, 15-16	11
KW	Wick	1-14	59	OL		13-14	7
KW		15-17	62	OX	Oxford	1-17	65
KY	Kirkcaldy	1-16	32	PA	Paisley	1-4	47
LA	Lancaster	1-23	7	PA		5-19	43
LD	Llandrindod	1-8	54	PA	Paisley	20-27, 33, 35, 40-	68
LD		3	3	PA		49	68
LE	Leicester	1-5, 7-8, 11-14,	63	PA	Paisley	28-31	69
LE		16-17	63	PA		32, 34, 36-39, 61	70
LE	Leicester	6, 9-10	63	PA		62-78	68
LE		15	64	PA	Paisley	80-82, 88	71
LL	Llandudno	11-15	25	PA		83-87	72
LL		16-19	26	PE	Peterborough	1-15, 34, 38	64
LL	Llandudno	20-21, 23, 27, 31-	25	PE		16-19	22
LL		32, 34-40, 42-47	25	PE	Peterborough	20-25	40
LL	Llandudno	22, 24-26, 28-30,	26	PE		30-33, 35-37	57
LL		33-34, 41, 48-49,	26	PH	Perth	1-2, 8-9, 10-18	31
LL		51, 78	26	PH		3-7	32
LN	Lincoln	1-6, 8-10	40	PH	Perth	19-26, 30-44	58
LN		7, 11-13	39	PL	Plymouth	1-21	73
				PL		22-35	74
				PO	Portsmouth	1-22	13
				PO	I.O.W.	30-41	75
				PR	Preston	1-9	7
				RG	Reading	1-17, 26	53
				RG		21-25, 27	50
				RG	Reading	28	4
				RH	Redhill	1-3, 6-7, 9-20	12
				RH		4-5	50
				RH	Redhill	8	29
<b>SUB POSTCODE DIVISION</b>							
LN	Lincoln	3-4, 3-5	40				
LN		3-6	39				
LS	Leeds	1-29	8				
LU	Luton	1-6	2				
LU		7	22				
L	Liverpool	1-49, 60-70	24				
ME	Medway	3	29				
ME		1-2, 4-20, 99	36				

Post-code Letter	Town	Post-code Number	Service Force Key Number	Post-code Letter	Town	Post-code Number	Service Force Key Number
RM	Romford	1-5, 7, 10-18	27	TR	Truro	1-27	74
RM		6, 8-9	28	TS	Stockton-on-		
SA	Swansea	1-18, 31-32	3		Tees	1-29	37
SA		33-39, 41-44, 61-73	76	TW	Twickenham	1-20	51
SA	Swansea	19-20, 40, 45-48	77	UB	Uxbridge	1-10	2
SE	London	All <b>SE</b> Codes	14	WA	Warrington	1-5, 8-9, 10-15	11
SG	Stevenage	1-9, 11,15	2	WA		6-7	24
SG		10, 12-14	28	WA	Warrington	16	30
SG	Stevenage	16-19	22	WC	London	All <b>WC</b> Codes	44
SK	Stockport	1-3, 6-12	30	WD	Watford	1-2, 4-7	2
SK		4-5, 13-16	11	WD		3	53
SK	Stockport	17	33	WF	Wakefield	1-17	8
SL	Slough	1-10	53	WN	Wigan	1-5, 7	11
SM	Sutton	1-3, 7	51	WN		6,8	24
SM		4-6	29	WR	Worcester	1-14	19
SN	Swindon	1-8, 11-16	65	WR		15	41
SN		9-10	4	WS	Walsall	1-15	18
SO	Southampton	1, 4, 41 -43, 51	9	WV	Wolverhampton	1-4, 10-14	18
SO		2-3, 5, 21-24, 52	13	WV		5-9, 15-16	41
SO	Southampton	20	4	W	London	All <b>West</b> Codes	52
SP	Salisbury	1-5, 9-11	4			<b>Except</b> 1-14	
SP		6	9	W	London	3, 4, 5, 7, 13	2
SP	Salisbury	7-8	9	W	London	1-2, 6, 8-12, 14	44
SR	Sunderland	1-7, 9	66	YO	York	1-3, 5, 7-8	8
SR		8	37	YO		4, 6, 11-18, 25	38
SS	Southend-on-			YO	York	21-22	37
	Sea	0-9, 11-17 ,99	27	ZE	Lerwick	1, 3	79
ST	Stoke-on-			ZE		2	80
	Trent	1-18, 20-21	30				
ST		19	18				
SW	London	2, 9, 16	14				
SW	London	1-3, 5-7, 10	44				
SW	London	4, 8, 11-15, 17-20	51				
SY	Shrewsbury	1-6, 9-17, 18-22	25				
SY		7, 17-19	54				
SY	Shrewsbury	8	41				
SY		23-25	77				
S	Sheffield	1-19, 30-31, 40-45	33				
S		60-66, 74, 80-81	33				
S	Sheffield	70-73, 75	8				
TA	Taunton	1-11, 21-24	6				
TA		12-20	5				
TD	Selkirk	1-15	35				
TF	Telford	1-8, 10-13	41				
TF		9	30				
TN	Tonbridge	1-2, 4, 8-11, 13-16	29				
TN		12, 17-19, 23-40	36				
TN	Tonbridge	3, 5-7	12				
TQ	Torquay	1-6, 9, 12-13	78				
TQ		7-8	73				
TQ		14	45				

Service Force Key Number	Service Force Address	Telephone Number	Service Force Key Number	Service Force Address	Telephone Number
1	60 Commerce Street, Aberdeen, AB2 1BP or Tel:	0224 583949 0224 582704	40	Unit 14 Stonefield Park, Clifton Street, Lincoln	0522 532330
2	Unit 4, Riverside Est, Coldharbour Ln, Harpenden	0582 461909	41	1 Underhill Street, Bridgnorth, Salop, WV16	0746 763322
3	3 Pentwyn Road, Blackwood, Gwent, Sth Wales	0495 223151	42	38 Buccleuch Street, Dalkeith, Midlothian, EH22	031 663 7758
4	31 St Andrews Road, Bemerton, Salisbury, SP2	0722 336072	43	Block 2 Unit 5, Auchenraith Ind. Est. Rosendale Way, Blantyre	0698 828145
5	3 Bancombe Ct. Trad. Est., Martock, Yeovil, TA12	0935 822836	44	4 Royal Lane, Yiewsley, W- Drayton, UB7	0895 441917
6	80 Killigrew Street, Falmouth, Cornwall, TR11	0984 31858	45	91 Exeter Road, Exmouth, Devon, EX8 1QD	0395 263531
7	333 Ranglet Road, Walton Summit, Preston, PR5	0772 321200	46	3 Bear St, Barnstaple, North Devon, EX32	0271 71774
8	57 Ingram Road, Holbeck, Leeds, Yorks,	0532 460992	47	Unit E6C Anniesland Ind. Est. Netherton Rd, Glasgow, Scotland	041 954 5304
9	63 Curzon Road, Bournemouth, BH1 4PW	0202 303363		or Tel:	041 954 5349
10	Unit 2, Furnace Road, Ilkeston, Derbyshire	0602 442770	48	Blencathra, Saumarez Lane, Castel, Guernsey	0481 56854
11	Unit 41/42 Clarendon Ct, Winwick Quay, W'ton	0925 50822	49	134 Eastgate Street, Gloucester, GL1 1QT	0452 422488
12	Unit 3, 21/25 Bridge Road, Haywards Heath, RH1	0444 417656	50	Unit 1 Redfields Ind. Pk, Church Crookham, Fleet	0252 851414
13	266 Main Road, Southbourne, Emsworth, PO10 or Tel:	0243 374814 0243 371170	51	127 Walton Road, Molesey, Surrey, KT8 0DT or Tel:	081 9796366 081 9797962
14	9 Bourne Road, Bromley, Kent, BR2 9PB	081 3139533	52	Unit 4, Riverside Est, Coldharbour Ln, Harpenden	0582 461909
15	Unit 1, Albert Crescent, Bristol, BS2 0YH	0272 713217	53	Reform Road, Maidenhead, Berkshire	0628 783711
16	Owenmore Hse, Kilwee Ind. Est., Upper Dunmurry Lane, Belfast	0232 301121	54	Merion House, High Street, Llandrindod Wells	0597 824842
17	66 Birch Rd East, Wyreley Rd Ind. Est, B'ham	021 327 1671	55	South Quay Industrial Estate, Douglas, I.O.M.	0624 622114
18	Unit 3 Sterling Park, Claymore, Tamworth or Tel:	0827 289800 0827 289822	56	Unit 2b, Elton Park Business Centre, Hadleigh Rd, Ipswich, IP2 0DQ	0473 211713
19	22 Newton Road, Malvern, Worcester, WR141NZ	0684 572915	57	75 Grove Road, Norwich, NR1 3RL	0603 629653
20	Unit 23/24, Alliance Business PK, Townsend Drv, Nuneaton, CV11	0203 350666	58	Unit 3B3, Smithton Ind. Est. Smithton, Inverness	0463 791822
21	High Ehenside, Egremont, Cumbria, CA22	0946 820509	59	Drummuie Road, Golspie, Sutherland, KW10 6SY	0408 633517
22	1 Wharf Road, Higham Ferrers, Northants	0933 317727	60	P.O.Box 45, Queens Road, St Helier, Jersey	0534 67001
23	Unit 2b, Elton Park Business Centre, Hadleigh Road, Ipswich, IP2 1DQ	0473 211713	61	Bruach, Blackwaterfoot, Isle of Arran	077 086 246
24	Unit 14, Dock Road, Birkenhead, L41 1JJ	051 639 1287	62	Hatson Ind. Estate, Kirkwall, Orkney	0856 5457
25	Plas Fynnon W/house, Middleton Rd, Oswestry	0691 652917	63	75 St Marys Road, Market Harborough, Leics	0858 433229
26	Easy Launderette, Pantan Hall, Denbigh, Clwyd	0745 81 3272	64	Pinfold Rd, Manning Rd Ind. Est. Bourne, Lincs	0778 422147
27	19 Sirdar Rd, Off Brook Rd, Rayleigh, Essex	0268 741171	65	Unit E19, Telford Rd, Launton Ind. Est. Bicester	0869 248598
28	284 Alma Road, Enfield, EN3	081 805 6825	66	Unit C1, Bergen Cl, Tyne Tunnel Trad. Estate, North Shields, Tyne & Wear	091 2960166
29	Unit B4, Imperial Bus. Estate, Gravesend, Kent	0474 353771	67	53 Sandringham Road, Northampton, NN1	0604 37061
30	Unit 8, Croft Road, Newcastle under Lyme, Staffs, ST5 0TW	0782 713003	68	96 Argyll Street, Dunoon, Argyll, PA23 7NE	0369 2147
31	3-7 Blackness Street, Dundee, Scotland, DD1 or Tel: or Tel:	0382 642828 0382 455862 0382 826809	69	43 Crosshill Avenue, Cambeltown, Argyll	0586 52008
32	33a Burnside, Auchtermuchty, Fife, Scotland	0337 28807	70	Moss Field Workshop, Moss Field Drive, Oban	0631 664530
33	Unit 63, Storforth Ln Trad. Est. Chesterfield	0246 231790	71	2 Killweivagh, Gregory, Benbecula, Outer Hebrides	0870 2331
34	93 Irish Street, Dumfries, Scotland	0387 69694	72	Churchouse, 16 James St, Stornaway, Isle of Lewis	0851 705555
35	2-8 Wood Market, Kelso, Borders, TD5 7AX	0573 24411	73	16 Faraday Mill, Cattedown, Plymouth, PL4	0752 257455
36	Unit 2, Bridge Rd Bus. Centre, Bridge Road, Ashford, Kent, TN23 1BB	0233 613463	74	80 Killigrew Street, Falmouth, Cornwall, TR11	0326 314600
37	8 Cumbie Way, Aycliffe Ind. Est. Newton Aycliffe	0325 300606	75	109-111 Hunnyhill, Newport, Isle of Wight	0983 523062
38	Unit 1, Boulevard Unit Fact. Est. Hull, HU3 4AY	0482 223335	76	Roch, Haverfordwest, Dyfed	0437 710366
39	Unit 2, Cromwell Road, Grimsby, DN31 2BN	0472 358760	77	Unit 16, Llambod Ind. Est., Lampeter, SA48	0570 423424
			78	278 Torquay Road, Preston, Paignton	0803 529969
			79	3-4 Carlton Place, Lerwick, Shetland, ZE1	0595 2915
			80	Harlsdale, Symbister, Whalasa, Shetland	08066 546
			81	London House, Victoria Str., Alderney	048182 3563

# PEACE OF MIND FOR TWELVE MONTHS

## ZANUSSI

## GUARANTEE

## CONDITIONS

This guarantee is in addition to your statutory and other legal rights which will not be excluded or in any way diminished by the return of this guarantee card.

We, Zanussi Ltd., undertake that if, within twelve months of the date of the purchase, this ZANUSSI appliance or any part thereof is proved to be defective by reason only of faulty workmanship or materials, we will, at our option, repair or replace the same **FREE OF ANY CHARGE** for labour, materials or carriage on condition that:

- \* The appliance has been correctly installed and used only on the electricity supply stated on the rating plate.
- \* The appliance has been used for normal domestic purposes only, and in accordance with the manufacturer's operating and maintenance instructions.
- \* The appliance has not been serviced, maintained, repaired, taken apart or tampered with by any person not authorised by us.
- \* The appliance is still in the possession of the original purchaser.

All service work under this guarantee must be undertaken by a Zanussi Service Force Centre.

Home visits are made between 8.30 am and 5.30 pm Monday to Friday. Visits may be available outside these hours in which case a premium will be charged.

Any appliance or defective part replaced shall become our property.

## EXCLUSIONS

This guarantee does not cover:

- \* Damage or calls resulting from transportation, improper use or neglect, the replacement of any light bulbs or removable parts of glass or plastic.
- \* Costs incurred for calls to put right machines improperly installed or calls to machines outside the UK and the Republic of Ireland.
- \* Appliances found to be in use within a commercial or similar environment, plus those which are the subject to rental agreements.
- \* Products of Zanussi manufacture which are NOT marketed by Zanussi Ltd.
- \* EEC Countries - The standard guarantee is applicable but subject to the owner's responsibility and cost to ensure the appliance meets the standards set by the country to which the product is taken. The Zanussi company in the country concerned will be pleased to advise further. Sight of your purchase receipt will be required by them.



# ... OR FIVE YEARS

## ZANUSSI 5 YEAR

### COVER CONDITIONS

For a once-only payment you can extend your Standard Guarantee to 5 years.

All the conditions and exclusions of the Standard Guarantee apply.

## NOTES

1. Products supplied as "seconds", refurbished, damaged, or shop-soiled are not eligible for Zanussi 5 Year Cover.
2. The issue of a cover does NOT by virtue of our having done so, nullify the exclusions.
3. The Engineer will need to check the details of your Certificate and may make a charge for his services if it is not presented to him at the time of his call.
4. The date of purchase, or the date of initial payment (deposit) of the appliance will be deemed the date of commencement of cover.
5. Covers issued are not refundable or transferable.

## GUARANTEE RECORD

Appliance purchased from..... on.....

Guarantee card no..... Model no.....

Serial no..... (These details may be taken from your Guarantee Record Card)

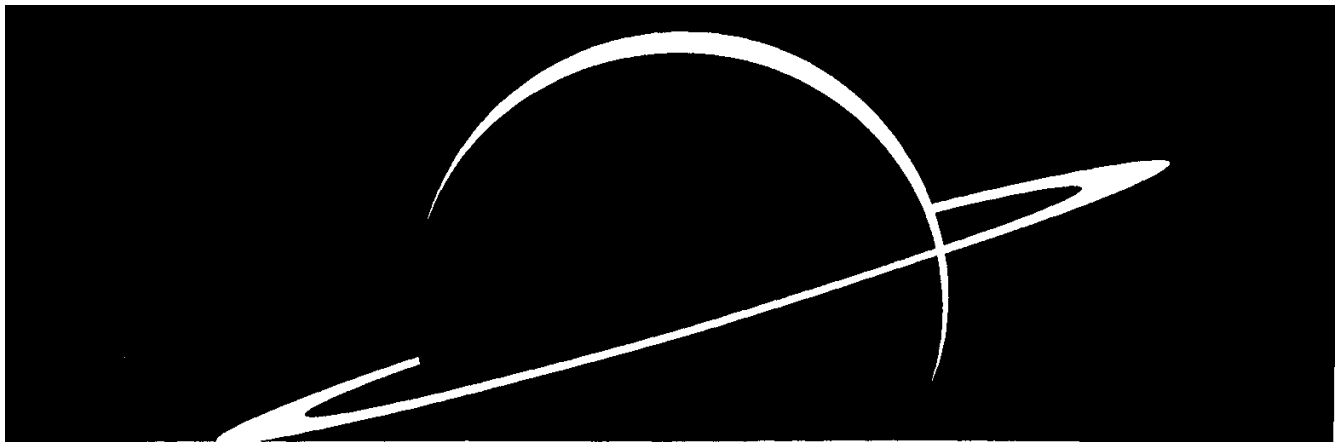

# ZANUSSI

The appliance of science

Zanussi Ltd., Zanussi House, Newbury

The information in this manual is correct at time of going to press.  
Zanussi reserve the right to alter specifications without notice.