

SAMSUNG

Samsung SilverCare™ Washer Owner's Manual

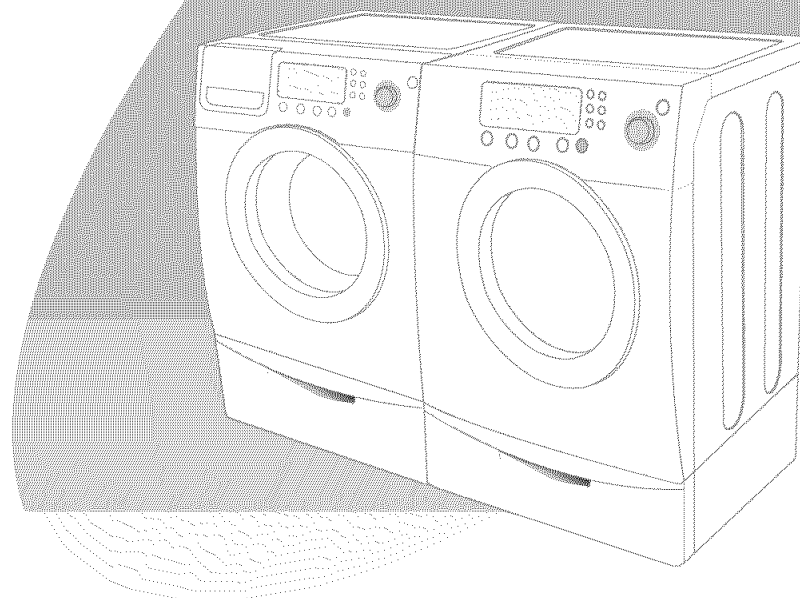

Register your product at
www.samsung.com/global/register
Code No.: DC68-02291A-08_EN

Features

1. SilverCare™ Sanitization

The winning combination! Samsung's silver nano technology combines the sanitizing effect of silver with state-of-the-art science for the ultimate in clean. Two plates of 99.9% pure silver are converted into silver ions through electrolysis. Even in cold, bleach-less water, the silver particles remove 99.9% of odor-causing bacteria for a "super clean" wash. So washing in cold water is energy efficient and better for your clothes.

2. Extra Large Capacity

Even bulky garments and blankets get super clean. The large 3.79 cu.ft. capacity leaves enough room for a more thorough, cleaner wash.

3. High Efficiency Energy & Water Saving

Washing with Samsung's SilverCare™, even in cold water, sanitizes the laundry thereby saves 92% energy used when compared to that with hot water sanitization.

4. Direct Drive Inverter Motor

The power to handle anything! Our direct-drive inverter motor delivers power right to the washer tub from a variable speed, reversible motor.

A beltless direct-drive motor generates a higher spin speed of 1,200rpms for more effective, quiet operation. The washer also has fewer moving parts, meaning fewer repairs.

5. Woolmark Certified

The machine wash wool cycle on the Samsung SilverCare™ machines has been tested and passed the required Woolmark Company specification for machine washable wool products. Fabrics should be washed according to the instructions on the garment label as specified by Woolmark and Samsung.

Pedestal with Storage Drawers An optional 15" pedestal is available to raise the washer for easier loading and unloading. It also offers a built-in storage drawer that can hold a 100 oz. bottle of detergent.

6. Stacking

Washer and dryer can be stacked to maximize usable space.

Safety Precautions

Congratulations on your new Samsung SilverCare™ Washer. This manual contains important information on the installation, use, and care of your appliance. Please take time to read this manual to take full advantage of your Washer's many benefits and features.

What you need to know about Safety Instructions

Warnings and Important Safety Instructions in this manual do not cover all possible conditions and situations that may occur. It is your responsibility to use common sense, caution, and care when installing, maintaining, and operating your Washer.

IMPORTANT SAFETY SYMBOLS, WORDS, LABELS



WARNING – Hazards or unsafe practices that **COULD** result in severe personal injury or death.



CAUTION – Hazards or unsafe practices that **COULD** result in minor personal injury or property damage.



WARNING – To reduce the risk of fire, explosion, electric shock, or personal injury when using your Washer, follow the basic safety precautions below:

1. Read all instructions before using the appliance.
2. As with any equipment using electricity and moving parts, potential hazards exist. To safely operate this appliance, become familiar with its operation and exercise care when using it.
3. Install and store your Washer away from weather exposure.
4. Install and level your Washer on a floor that can support its weight.
5. Your Washer must be properly grounded. Never plug it into an ungrounded outlet. See page A2 for details.
6. To avoid the possibility of fire or explosion:
 - Do not wash items that have been washed, soaked, or treated with gasoline, dry cleaning solvents, or other flammable or explosive substances. They give off vapors that could ignite or explode. Any material that has been exposed to cleaning solvent or other flammable liquids or solids should not be placed in your Washer until all traces of such liquids, solids, and fumes have been removed. Offending items include acetone, denatured alcohol, gasoline, kerosene, certain liquid household cleaners and spot removers, turpentine, waxes, and wax removers
 - Do not add gasoline, dry cleaning solvents, or other flammable or explosive substances to the wash water. They give off vapors that could ignite or explode.
 - Under certain conditions, hydrogen gas may be produced in a hot water system that has not been used for two weeks or more. **HYDROGEN GAS IS EXPLOSIVE.** If the hot water system has not been used for two weeks or more, turn on all hot water faucets and let the water flow for several minutes before using your Washer. This will release any hydrogen gas build-up. Since the gas is flammable, do not smoke or use open flame during this time.
7. Unplug power cord before attempting to service your Washer.
8. Do not reach into the appliance when the tumbler is moving.
9. Do not let children play on or in your Washer. Close supervision is a must when children are near the Washer.
10. Do not tamper with controls.
11. Do not repair, replace, or service any part of your Washer unless you fully understand the recommended user-repair instructions and have the skills to carry them out.
12. Store laundry aids and other material in a cool, dry place out of children's reach.
13. Do not wash or dry items that are soiled with vegetable or cooking oil. These items may contain some oil after laundering. Due to the remaining oil, the fabric may smoke or catch fire by itself.
14. Do not use chlorine bleach, ammonia, or acids (such as vinegar or rust remover) in the same wash. Hazardous fumes can form.
15. Do not machine wash fiberglass materials. Small particles can stick to fabrics washed in following loads and cause skin irritation.
16. Before your Washer is removed from service or discarded, remove the door to the washing compartment to avoid the danger of children or small animals getting trapped inside.
17. Do not sit on top of your Washer.
18. Inlet hoses are subject to damage and deterioration over time. Check the hoses periodically for bulges, kinks, cuts, wear or leaks, and replace them every five years.
19. Ensure pockets are free from small irregularly shaped hard objects, foreign material, etc. ie. coins, knives, pins, etc. These objects could damage your washer.
20. Do not wash clothing with large buckles, buttons, or other heavy metal.

SAVE THESE INSTRUCTIONS

Table of Contents

Installing Your Washer	A-1
UNPACKING YOUR WASHER	A-1
OVERVIEW OF YOUR WASHER	A-1
GROUNDING	A-2
WATER	A-2
DRAIN FACILITY	A-3
FLOORING	A-3
LOCATION CONSIDERATIONS	A-3
ALCOVE OR CLOSET INSTALLATION	A-3
IMPORTANT TO INSTALLER	A-4
Operating Instructions	B-1
LOADING YOUR WASHER	B-1
GETTING STARTED	B-2
Washing a Load of Laundry	C-1
OVERVIEW OF THE CONTROL PANEL	C-1
CHILD LOCK	C-4
GARMENT +	C-4
MY CYCLE	C-4
FOR SILVERCARE™ WASHING (select models)	C-5
DETERGENT USE	C-6
FEATURES	C-6
Maintaining Your Washer	D-1
CLEANING THE INTERIOR	D-1
CLEANING THE DISPENSERS	D-1
STORING YOUR WASHER	D-1
Troubleshooting	E-1
CHECK THESE POINTS IF YOUR WASHER....	E-1
INFORMATION CODES	E-3
Appendix	F-1
FABRIC CARE CHART	F-1
HELPING THE ENVIRONMENT	F-2
DECLARATION OF CONFORMITY	F-2
SPECIFICATION	F-2
CYCLE CHART	F-3

Installing Your Washer

UNPACKING YOUR WASHER

Unpack your Washer and inspect it for shipping damage. Make sure you have received all of the items shown below.

If your Washer was damaged during shipping, or you do not have all of the items, contact 1-800-SAMSUNG.

OVERVIEW OF YOUR WASHER

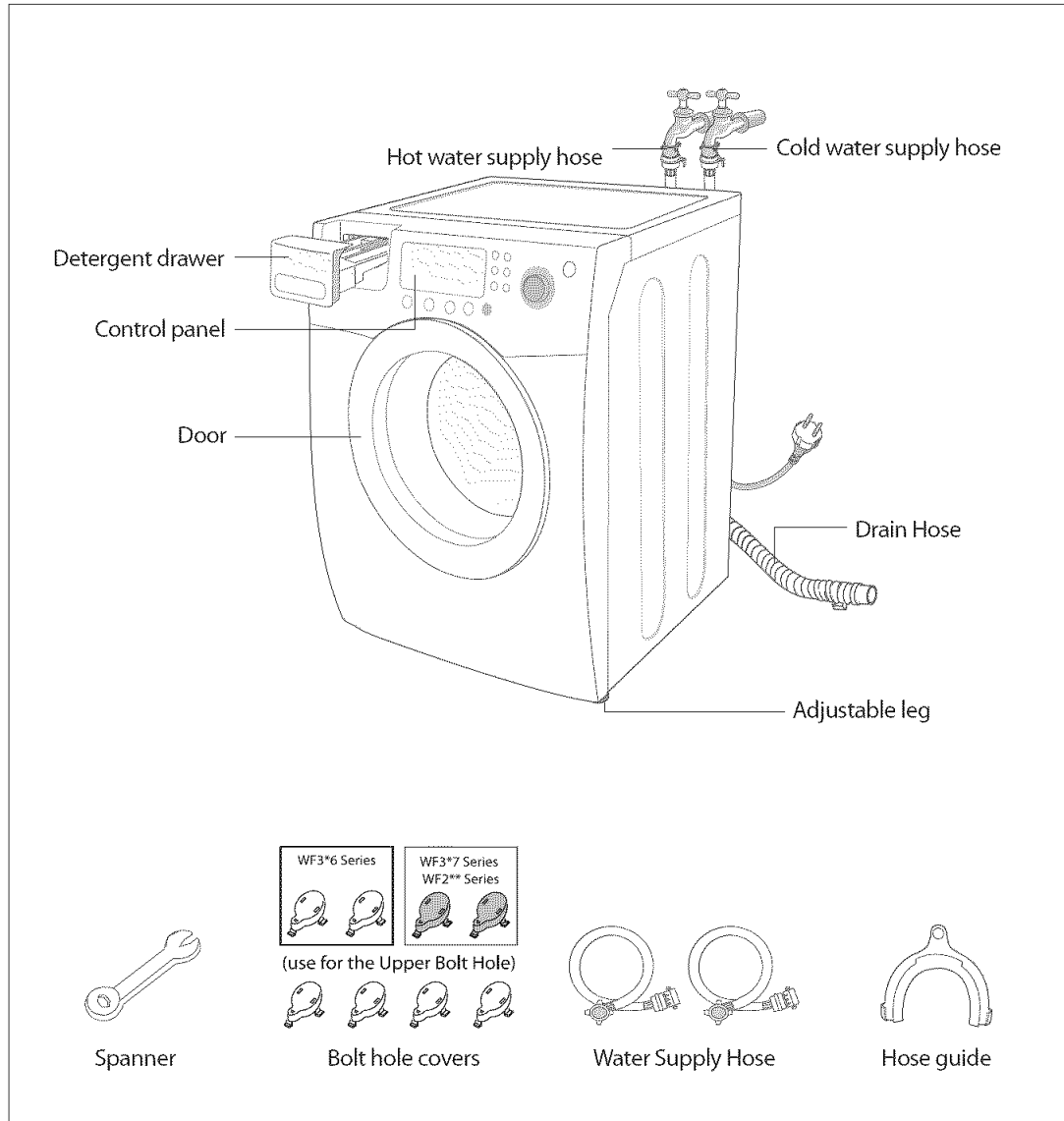

Installing Your Washer

BASIC LOCATION REQUIREMENTS:

ELECTRICAL

- 120 Volt 60 Hz 15 AMP fuse or circuit breaker
- Individual branch circuit serving only your Washer is recommended.
- Your Washer is equipped with a power cord.

NEVER USE AN EXTENSION CORD.

GROUNDING

ELECTRICAL GROUNDING IS REQUIRED ON THIS APPLIANCE.

This appliance must be grounded. In the event of malfunction or breakdown, grounding will reduce the risk of electric shock by providing a path of least resistance for electric current.

This appliance is equipped with a power cord having a three-prong grounding plug for use in a properly installed and grounded outlet.



WARNING - Improper connection of the equipment-grounding conductor can result in a risk of electrical shock. Check with a qualified electrician or serviceman if you are in doubt as to whether the appliance is properly grounded. Do not modify the plug provided with the appliance – if it does not fit the outlet, have a proper outlet installed by a qualified electrician.

IMPORTANT SAFETY PRECAUTIONS

- To prevent unnecessary risk of fire, electrical shock or personal injury, all wiring and grounding must be done in accordance with the National Electrical Code ANSI/FNPA, No. 70 Latest Revision and local codes and ordinances. It is the personal responsibility of the appliance owner to provide adequate electrical service for this appliance.

NEVER CONNECT GROUND WIRE TO PLASTIC PLUMBING LINES, GAS LINES, OR HOT WATER PIPES.

WATER

To correctly fill your Washer in the proper amount of time, water pressure of 20 – 120 psi is required. Water pressure less than 20 psi may cause water valve failure, not allowing the water valve to shut off completely. Or it may extend the fill time beyond what your Washer controls allow, resulting in your Washer turning off. A time limit is built into the controls in the event of an internal hose becoming loose and flooding your home.

The water faucets must be within 4 feet/122cm of the back of your Washer for the inlet hoses provided with your Washer.

NOTE: Accessory inlet hoses are available in various lengths up to 10 feet/305cm for faucets that are further away from the back of your Washer.

To avoid the possibility of water damage:

- Have water faucets easily accessible
- Turn off faucets when Washer is not in use.
- Periodically check there is no leakage at water inlet hose fittings.



WARNING - CHECK ALL CONNECTIONS AT THE WATER VALVE AND FAUCET FOR LEAKS.

Installing Your Washer

DRAIN FACILITY

The recommended height of the standpipe is 18 in/46 cm. The drain hose must be routed through the drain hose clip to the standpipe. Standpipe must be large enough to accept the outside diameter of the drain hose. The drain hose is attached at the factory.

FLOORING

For best performance, your Washer must be installed on a solidly constructed floor. Wood floors may need to be reinforced to minimize vibration and/or unbalanced load situations. Carpeting and soft tile surfaces are contributing factors in vibration and/or tendency for your Washer to move slightly during the spin cycle.

Never install your Washer on a platform or weakly supported structure.

LOCATION CONSIDERATIONS

Do not install your Washer in areas where water may freeze, since your Washer will always maintain some water in its water valve, pump, and hose areas. This can cause damage to belts, pump, hoses and other components. Operating temperature should be above 60°F/16°C.

ALCOVE OR CLOSET INSTALLATION

MINIMUM CLEARANCES FOR CLOSET AND ALCOVE INSTALLATIONS:

Sides – 1 in / 25 mm	Rear – 2.375 in / 60 mm
Top – 17 in / 432 mm	Closet Front – 2 in / 51 mm

If both Washer and Dryer are installed together, the closet front must have at least 72 in² or 465 cm² of an unobstructed air opening. Your Washer alone does not require a specific air opening.

Installing Your Washer

IMPORTANT TO INSTALLER

Please read the following instructions carefully before installing your Washer. These instructions should be retained for future reference

STEP 1

Removing the Shipping Bolts

Before using your Washer, you must remove the four shipping bolts from the back of the unit.

1. Loosen all bolts with the supplied spanner.
2. Slide the bolt and spacer up and remove the bolt with spacer through the hole in the rear wall of your Washer. Repeat for each bolt.
3. Fill the holes with the supplied plastic covers.
4. Keep the shipping bolts and spacers for future use.

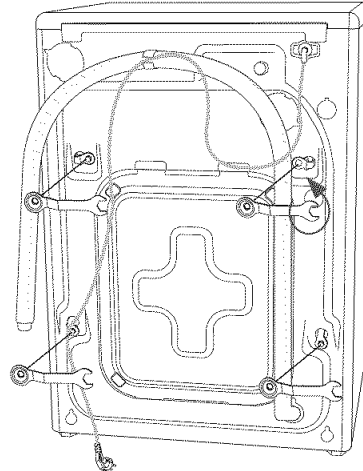

STEP 2

Selecting a Location

Before you install your Washer, make sure the location:

- Has a hard, level surface
- Is away from direct sunlight
- Has adequate ventilation
- Will not be freezing (below 32°F or 0°C)
- Is away from heat sources such as oil or gas
- Has enough space so that your Washer need not stand on its power cord
- Doesn't have any carpeting that will obstruct ventilation openings.

STEP 3

Installing your Washer

1. Place the drain hose in the drain facility. Be sure an airtight connection is NOT made between the drain hose and the standpipe.

Standpipe must be at least 18 in or 46 cm high.

NOTE: Caution must always be exercised to avoid collapsing or damaging the drain hose. For best results, the drain hose should not be restricted in any way – by elbows, couplings, or excessive lengths. For situations where the drain hose cannot be conveniently elevated to at least 18 in or 46 cm, the drain hose must be supported.

2. Check the inlet hose to ensure a washer is inside each fill hose. Thread the inlet hoses to the HOT and COLD faucet connections. On the other end of the hose, check for one rubber washer per hose and install each fill hose to the water valve. Make sure the hose with the red line is attached to the HOT faucet. Tighten by hand until snug, then two-thirds of a turn with pliers.

NOTE: For correct water use, connect both HOT and COLD water valves. If one is not connected, "nF" (no fill) error can occur.

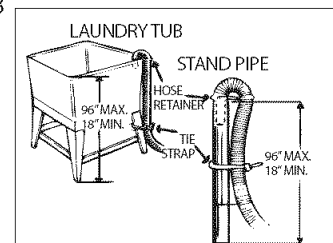
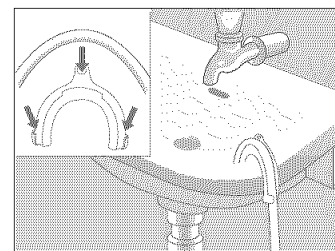

Installing Your Washer

3. Turn on "HOT" and "COLD" water supply and check all connections at the water valve and the faucet for leaks.

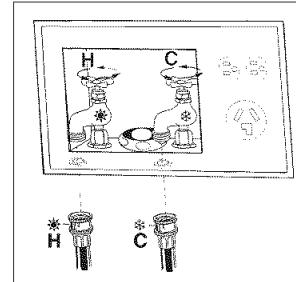

4. Plug power cord into a 3-Prong, well grounded 120 volt 60 Hz approved electrical outlet protected by a 15-amp fuse or comparable circuit breaker.
Your Washer is grounded through the third prong of the power cord when plugged into a three-prong grounded receptacle.

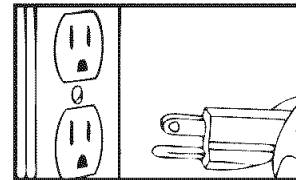

5. Slide your Washer into position.

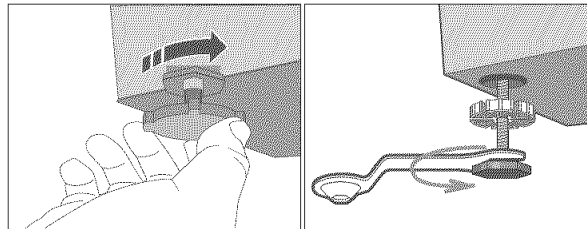

6. Level your Washer by turning the leveling legs in or out as necessary by hand or wrench included with your Washer.

When your Washer is level, tighten the nuts using the wrench or (-)driver.

NOTE: Your Washer must be leveled on all four sides. A carpenter's level should be used on all four corners of your Washer. It's a good idea after the first dozen washes to recheck your Washer's levelness.

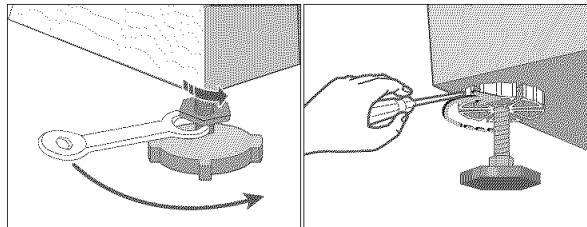

7. If you install your washer on soft floor, you should place the rubber cup under adjustable leg. Before put rubber cup, please remove film for double-side tape attached on rubber cup.

NOTE: If washer is installed on riser, you should put rubber cup under leg for riser.

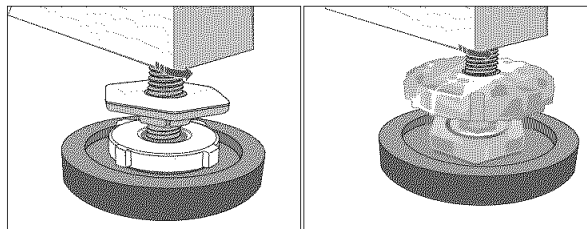

Operating Instructions

LOADING YOUR WASHER

- You can fill the tub with dry, unfolded clothes; but **DO NOT OVERLOAD** the tub.
- Overloading may reduce washing efficiency, cause excess wear, and possibly cause creasing or wrinkling of the load.
- Wash delicate items such as bras, hosiery, and other lingerie in the Delicates/Hand Wash cycle with similar lightweight items.
- When washing big bulky items or a few smaller items that don't fill the tub completely – a rug, a pillow, stuffed toys, or one or two sweaters, for example – add a few towels to improve tumbling and spin performance.
- When washing heavily soiled loads, not overloading your Washer is very important to assure good cleaning results.
- To add a forgotten item:
 - 1) Press the Cycle Selector dial
 - 2) Wait for the Door Lock light to go out (5 seconds)
 - 3) Add the item, close the door, and press the Cycle Selector dial.After a pause of 10 seconds, the cycle will resume.
NOTE: To ensure thorough cleaning, add items within five minutes of starting the wash cycle.

Try washing Bedding, Towels, undergarments, and other articles that usually have close body contact using the SilverCare™ Option, which Sanitizes using Cold Water.

Operating Instructions

GETTING STARTED

1. Load your Washer.
2. Close the door.
3. Add detergent and additives to the dispenser (see pages C6~C7).
4. Select the appropriate cycle and options for the load (see pages C2~C5).
5. Press the Cycle Selector dial.
6. The Wash Indicator light will illuminate.
7. The estimated cycle time will appear in the display.
The time may fluctuate to better indicate the time remaining in the cycle.
8. Before your Washer starts to fill, it will make a series of clicking noises to check the door lock and do a quick drain.

NOTES:

- When the cycle is complete, the Door Lock light will go out and "End" will appear in the display.
- DO NOT attempt to open the door until the Door Lock light is off. To add a forgotten item, see "Loading your Washer" section.
- When your Washer is restarted after a pause, expect a delay of up to 15 seconds before the cycle continues.
- Pressing Power cancels the cycle and stops your Washer.
- The Pre Wash (select models), Wash, Rinse and Spin indicator lights will illuminate during those portions of the cycle.

Washing a Load of Laundry

OVERVIEW OF THE CONTROL PANEL

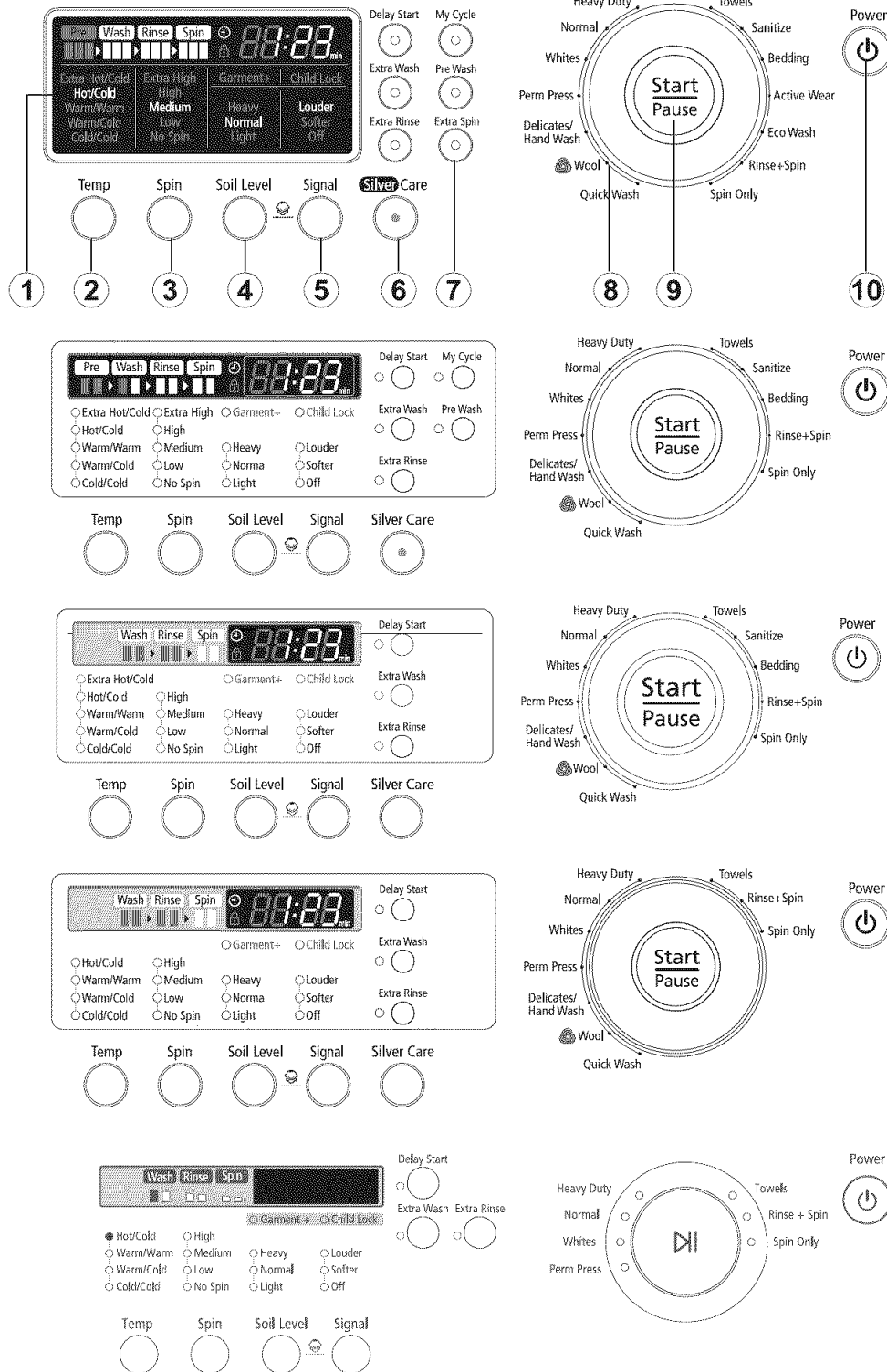

Washing a Load of Laundry

- 1. Digital graphic display**
Displays the remaining cycle time, all cycle information, and error messages.
- 2. Temperature selection button**
Press the button repeatedly to cycle through the different water temperature options.
Extra Hot/Cold - Heavily soiled, colorfast items. Only available with the Sanitize cycle.
Hot/Cold - Whites and heavily soiled, colorfast items.
Warm/Warm - Colorfast items. When warm rinse is selected, only the final rinse will be warm. The other rinses will be cold to conserve energy.
Warm/Cold - Moderately soiled, colorfast items; most wrinkle-free items.
Cold/Cold - Brightly colored, very lightly soiled items; washable woolsens.
- 3. Spin selection button**
Press the button repeatedly to cycle through the different spin speed options.
Extra High - Removes more water from loads during spin.
NOTE: To minimize wrinkling of wrinkle-free and no-iron fabrics, DO NOT use the Extra High spin option for these loads, nor overload your Washer.
High - Use for underwear, t-shirts, jeans and sturdy cottons.
Medium - Use for jeans, wrinkle-free or wash-and-wear items and synthetics.
Low - Use for delicate items needing a slow spin speed.
No Spin - Drains your Washer without spinning. Use for extremely delicate items that cannot tolerate any spin.
- 4. Soil Level selection button**
Press the button to select the Soil Level/washing time.
Heavy - For heavily soiled loads.
Normal - For moderately soiled loads. This setting is best for most loads.
Light - For lightly soiled loads.
- 5. Signal selection button**
Press the button to increase or decrease the end of cycle signal volume or turn off the signal.
- 6. SilverCare™ button**
Press this button to sanitize your laundry in cold water.

Active silver ions are produced from pure silver plates by the process of electrolysis and released into the wash water effectively sanitizing your wash, even in cold water, without bleach. The SilverCare™ system sanitizes with 92% less energy use than a traditional heat sanitization.

Washing a Load of Laundry

7. Select Cycle Option

Delay Start - Any cycle can be delayed for up to 12, 19 or 24 hours (select models) in one-hour increments. Displayed hour indicates the time at which the wash will be finished.

Extra Wash - Add additional time to the wash for better stain removal.

Extra Rinse - Add an additional rinse at the end of the cycle to more thoroughly remove laundry additives and perfumes.

Extra Spin - Add additional time to remove more water from loads

My Cycle - Choose your favorite cycle including temperature, spin, soil level, option, etc.

Pre Wash - To use this feature add detergent to the Pre Wash selection of the detergent compartment. When turned on, the washer fills with cold water and detergent, tumbles, then drains and advances to the selected wash cycle. Some cycles cannot be selected with this option.*

* You cannot select PreWash option in the Delicate/Hand Wash, Wool, Quick Wash and Active Wear cycles.

8. Cycle Selector

Select the appropriate cycle for the type of load.

This will determine the tumble pattern and spin speed for the cycle.

NOTE: To minimize wrinkling of laundry, select the Perm Press cycle.

Heavy Duty - For sturdy, colorfast fabrics and heavily soiled garments.

Normal - For most fabrics including cottons, linens, and normally soiled garments.

Whites - For white fabrics with or without bleach.

Perm Press - For wash-and-wear, synthetic fabrics, and lightly to normally soiled garments.

Delicates/Hand Wash - For sheer fabrics, bras, lingerie silk, and other handwash-only fabrics. For best results, use liquid detergent.

Wool - For machine-washable wool. Loads should be under 8 pounds.



The wool wash cycle of this machine has been approved by Woolmark for the washing of machine washable Woolmark products provided that the products are washed according to the instructions on the garment label and those issued by the manufacturer of this washing machine, M0509.

Quick Wash - For lightly soiled garments needed quickly.

Towels - For bath towels and washcloths. Due to their high absorbency, wash no more than a half load (6 pounds) of towels at a time for best results

Sanitize - For heavily soiled, colorfast garments. This cycle heats the water to 150°F to eliminate bacteria.

NOTE: If Pause is selected during the heating portion of the Sanitize Cycle, your Washer door will remain locked for your safety.

Bedding - For bulky items such as blankets and sheets.

Active Wear - For washable sportswear.

Eco Wash - For geographic areas where energy and water conservation is needed. It saves an additional 5% of Energy and 5% of water consumption.

Rinse + Spin - Use for loads that need rinsing only or to add rinse-added fabric softener to a load.

Spin Only - Provides a spin to remove more water.

9. Start/Pause selection button

Press to pause and restart programs.

10. Power button

Press once to turn your Washer on, press again to turn your Washer off. If left on for more than 10 minutes without any buttons being touched, the power automatically turns off.

NOTE: Cycles and options vary by model. Refer to cycle chart in Appendix.

Washing a Load of Laundry

CHILD LOCK

A function that prevents children from playing with your Washer.

ACTIVATING/DEACTIVATING

If you want to activate/deactivate the Child Lock function, press the **Soil Level** and **Signal** buttons at the same time for 3 seconds.

How It Works:

1. Child Lock can be activated while your Washer is running.
2. Once you activate Child Lock, all controls (except for the Power button) will be locked until you deactivate Child Lock.
3. The Child Lock button will be lit while it is in effect.

Note: When buttons, other than the Power button, do not respond, please check if the Child Lock function is on.

GARMENT +

You can add or take out laundry items even after the wash has started, as long as the Garment+ light is on. Pushing the Start/Pause button unlocks the door, unless the water is too hot or if there is too much water in your Washer. If you are able to unlock the door and wish to continue the wash cycle, close the door and press the Start/Pause button.

MY CYCLE

Allows you to activate your custom wash (temperature, spin, soil level, etc.) with one-button convenience.

By pushing the My Cycle button, you activate the settings used during the last My Cycle mode. The My Cycle light will indicate activation.

You can select all options as follows in My Cycle mode.

1. Select cycle using Cycle Selector dial.
2. After cycle selection, set each option.
Note: At this time, the option will follow as per each cycle's default option selection.
3. Then, you can start My Cycle by pushing the Start/Pause button in My Cycle mode.
The cycle and options you select will be displayed next time you choose My Cycle.

Note: You can change My Cycle setting by repeating same process above.
The last used setting will be displayed at the next time you choose My Cycle.

Washing a Load of Laundry

FOR SILVERCARE™ WASHING (select models)

An increased consumer demand for energy-saving products prompted Samsung to develop a system to use silver, widely known for its antimicrobial properties, as a sanitizing agent in your washing machine. Pure silver atoms have an electron stripped away by electrolysis during the wash and rinse cycles, which releases up to 16 million trillion silver ions that then penetrate deep into the fabric to sanitize clothing (according to U.S. EPA Test Guideline DIS/TSS-13) without the need for hot water or bleach.

Here's how it works: A grapefruit-sized device alongside the tub uses two pure silver plates the size of large chewing gum sticks as electrodes in the water inlet system. The resulting positively charged silver atoms - Silver ions (Ag+) – are sprayed into the tub during the wash and final rinse cycle.

This process removed or killed greater than 99.9% of tested bacteria.

Samsung's SilverCare™ Technology provides a 92% energy savings over hot water sanitization. Extra delicate blouses, shirts, or even lingerie that can't be washed in hot water can now be sanitized effectively without the adverse effects of hot water sanitization that is normally a concern with those types of articles. The silver plates carry a warranty of ten years, and can easily be replaced by a Service Technician if so needed.

1. Load the washer.
2. Press the Power button.
3. Select a Cycle by turning the Cycle Selection dial.
4. Press SilverCare™ button.
5. Add detergent in the dispenser tray for main washing, and add fabric softener up to the marked line.
6. Press the Start/Pause button.

: The washer automatically selects optimal washing conditions by sensing the laundry's weight.

Note :

FOR HOME USE ONLY– COMMERCIAL USERS SHOULD NOTIFY THEIR LOCAL WASTE TREATMENT AUTHORITIES BEFORE USE

The total number of silver cycles run by the washer is displayed when pushing the Signal button and the SilverCare™ button.

LU3 : less than 1000 times

LU2 : between 1000 to 2000 times

LU1 : between 2000 to 2999 times

LU0 : over 2999 times

You should replace the SilverCare™ kit when the display reads "LU0" as the electrodes are near the end of their useful life. Contact 1-800-SAMSUNG.

Note :

For some models that have no heater if you choose SilverCare™, the temperature will be automatically set to Cold/Cold.

You cannot choose the SilverCare™ option with the Wool cycle.

Washing a Load of Laundry

DETERGENT USE

Your Washer is designed to use high efficiency (HE) detergents.

- For best cleaning results, use a high efficiency detergent such as Tide HE, Wisk HE, Cheer HE or Gain HE*. High efficiency detergents contain suds suppressors that reduce or eliminate suds. When fewer suds are produced, the load tumbles more efficiently and cleaning is maximized.



!WARNING

Regular detergent is Not recommended. Please use only HE detergent.

NOTE: Reducing the amount of detergent may reduce cleaning. It is important to pre-treat stains, sort carefully by color and soil level, and avoid overloading.

* Brand names are trademarks of their respective manufacturers.

FEATURES

AUTOMATIC DISPENSER

Your Washer has separate compartments for dispensing detergent and color-safe bleach, chlorine bleach, and fabric softener. All laundry additives are added to their respective compartments before starting your Washer.

The automatic dispenser **MUST ALWAYS** be in place before starting your Washer.

DO NOT open the automatic dispenser when your Washer is running.

To use:

1. Pull out the dispenser drawer on the left side of the control panel.
2. Add recommended quantity of additive to the appropriate compartments with laundry additives, being careful not to overfill or spill.
3. Slide the dispenser drawer carefully and completely back into the compartment.

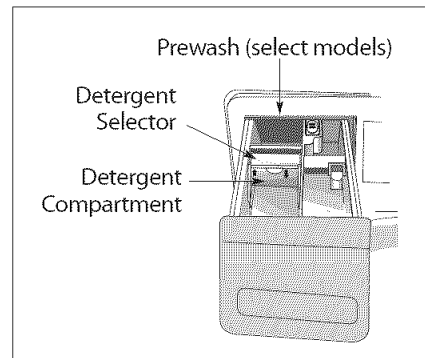

DETERGENT COMPARTMENT

1. Pour the recommended amount of laundry detergent directly into the detergent compartment before starting your Washer.
2. If color-safe bleach is to be used, it should be added with detergent to the detergent compartment.
 - When adding color-safe bleach with detergent, it is best if both laundry products are in the same form – granular or liquid.

NOTE: If using liquid detergent, lower the detergent selector and add the detergent to the detergent compartment.

Washing a Load of Laundry

PRE WASH COMPARTMENT (SELECT MODELS)

When using the Pre Wash option (select models), detergent should be added to both the Pre Wash compartment and the detergent compartment. The detergent will automatically be dispensed during Pre Wash.

- If high efficiency (HE) detergent is used, add 1/3 of the recommended amount to the Pre Wash compartment and 2/3 of the recommended amount to the detergent compartment.

BLEACH COMPARTMENT

(Liquid chlorine bleach only)

1. Add chlorine bleach to the bleach compartment.
DO NOT exceed the MAX FILL line.
2. Avoid splashing or over-filling the compartment.
3. Your Washer automatically dispenses bleach into the tub at the appropriate time.
4. The dispenser automatically dilutes liquid chlorine bleach before it reaches the wash load.

NOTES:

- Never pour undiluted liquid chlorine bleach directly onto the load or into the tub. It is a powerful chemical and can cause fabric damage, such as weakening of the fibers or color loss, if not used properly.
- If you prefer to use color-safe, non-chlorine bleach, add it to the appropriate detergent compartment.
DO NOT pour color-safe bleach into the chlorine bleach dispenser.

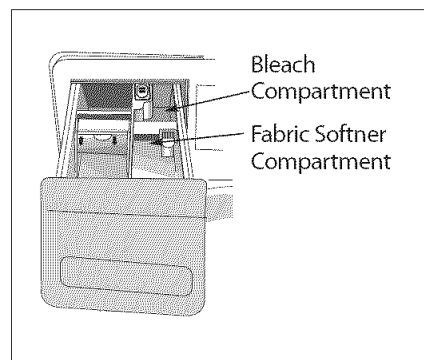

FABRIC SOFTENER COMPARTMENT

1. Pour the recommended amount of liquid fabric softener into the softener compartment.
For smaller loads, use less than one capful.
2. Fabric softener should be diluted with water until it reaches MAX FILL in the compartment.
3. The dispenser automatically releases liquid fabric softener at the proper time during the rinse cycle.

NOTES:

- Use the softener compartment ONLY for liquid fabric softeners.
- DO NOT use the Downy Ball* with this Washer. It will not add fabric softener at the appropriate time.
Use the automatic dispenser.
- * Brand names are trademarks of their respective manufacturers.

Maintaining Your Washer

CLEANING THE EXTERIOR

Turn off the water faucets after finishing the day's washing.

This will shut off the water supply to your Washer and prevent the unlikely possibility of damage from escaping water. Leave the door open to allow the inside of your Washer to dry out.

Use a soft cloth to wipe up all detergent, bleach or other spills as they occur.

Clean the following as recommended:

Control Panel – Clean with a soft, damp cloth. Do not use abrasive powders or cleaning pads.
Do not spray cleaners directly on the panel.

Cabinet – Clean with soap and water.

CLEANING THE INTERIOR

Clean the interior of your Washer periodically to remove any dirt, soil, odor, mold, mildew, or bacterial residue that may remain in your Washer as a result of washing clothes.

Failure to follow these instructions may result in unsatisfactory conditions, including unpleasant odor and/or permanent stains on your Washer or laundry.

Hard water deposits may be removed, if needed. Use a cleaner labeled "Washer safe".

CLEANING THE DISPENSERS

The Automatic Dispenser may need to be cleaned periodically due to laundry additive buildup.

1. Press the release lever on the inside of the dispenser and pull out.
2. Remove the cups from the fabric softener and bleach compartments.
3. Wash all of the parts under running water.
4. Clean the dispenser recess with a soft brush.
5. Reinsert the cups, pushing them firmly into place.
6. Push the dispenser back into place.
7. Run a Rinse & Spin cycle without any load in your Washer.

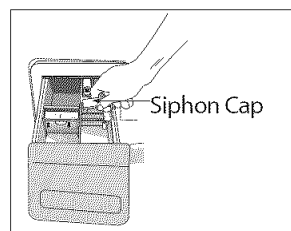
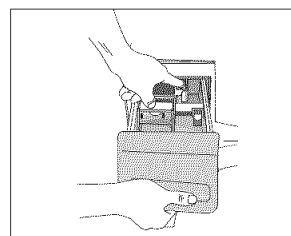

STORING YOUR WASHER

Washers can be damaged if water is not removed from hoses and internal components before storage.

Prepare your Washer for storage as follows:

- Select the Quick Wash cycle and add bleach to the automatic dispenser. Run your Washer through the cycle without a load.
- Turn the water faucets off and disconnect the inlet hoses.
- Unplug your Washer from the electrical outlet and leave your Washer door open to let air circulate inside the tumbler.
- If your Washer has been stored in below-freezing temperatures, allow time for any leftover water in your Washer to thaw out before use.

Troubleshooting

CHECK THESE POINTS IF YOUR WASHER...

<p>will not start..</p>	<ul style="list-style-type: none"> • Make sure door is firmly closed. • Make sure your Washer is plugged in. • Make sure the water source faucets are turned on. • Make sure to press the Cycle Selector dial to start your Washer. • Make sure the Child Lock is not activated; see page C4. • Before your Washer starts to fill, it will make a series of clicking noises to check the door lock and do a quick drain.
<p>has no water or not enough water..</p>	<ul style="list-style-type: none"> • Turn both faucets on fully. • Make sure the door is tightly closed. • Straighten water inlet hoses. • Disconnect hoses and clean screens. Hose filter screens may be plugged. • Open and close the door, then press the Cycle Selector dial.
<p>has detergent remains in the automatic dispenser after the wash cycle is complete.</p>	<ul style="list-style-type: none"> • Make sure your Washer is running with sufficient water pressure. • Make sure the Detergent Selector dial is in the upper position when using granular detergent.
<p>vibrates or is too noisy.</p>	<ul style="list-style-type: none"> • Make sure your Washer is set on a level surface. If the surface is not level, adjust your Washer feet to level the appliance. • Make sure that the shipping bolts are removed. • Make sure your Washer is not touching any other object. • Make sure the laundry load is balanced.
<p>stops</p>	<ul style="list-style-type: none"> • Plug cord into live electrical outlet. • Check fuse or reset circuit breaker. • Close door and press the Cycle Selector dial to start your Washer. For your safety, your Washer will not tumble or spin unless the door is closed. • Before your Washer starts to fill, it will make a series of clicking noises to check the door lock and do a quick drain. • There may be a pause or soak period in the cycle. Wait briefly and it may start. • Check screens on inlet hoses at the faucets for obstructions. Clean screens periodically.

Troubleshooting

<p>fills with the wrong temperature water.</p>	<ul style="list-style-type: none"> • Turn both faucets on fully. • Make sure temperature selection is correct. • Make sure hoses are connected to correct faucets. Flush water lines. • Check the water heater. It should be set to deliver a minimum 120° F (49° C) hot water at the tap. Also check water heater capacity and recovery rate. • Disconnect hoses and clean screens. Hose filter screens may be plugged. • As your Washer is filling, the water temperature may change as the automatic temperature control feature checks incoming water temperature. This is normal. • While your Washer is filling, you may notice just hot and/or just cold water going through the dispenser when cold or warm wash temperatures are selected. This is a normal function of the automatic temperature control feature as your Washer determines the temperature of the water.
<p>door locked shut or will not open.</p>	<ul style="list-style-type: none"> • Press the Cycle Selector dial to stop your Washer. • Your Washer door will remain locked during the heating portion of the Sanitize Cycle • It may take a few moments for the door lock mechanism to disengage.
<p>does not drain and/or spin.</p>	<ul style="list-style-type: none"> • Check fuse or reset circuit breaker. • Straighten drain hoses. Eliminate kinked hoses. If there is a drain restriction, call for service. • Close the door and press the Cycle Selector dial. For your safety, your Washer will not tumble or spin unless the door is closed.
<p>load is too wet at the end of the cycle.</p>	<ul style="list-style-type: none"> • Use the High or Extra High spin speed. • Use high efficiency detergent to reduce over-sudsing. • Load is too small. Very small loads (one or two items) may become unbalanced and not spin out completely.
<p>leaks water.</p>	<ul style="list-style-type: none"> • Make sure door is firmly closed. • Make sure hose connections are tight. • Make sure end of drain hose is correctly inserted and secured to drain facility. • Avoid overloading. • Use high efficiency detergent to prevent over-sudsing.
<p>has excessive suds.</p>	<ul style="list-style-type: none"> • Use high efficiency detergent to prevent over-sudsing. • Reduce detergent amount for soft water, small or lightly soiled loads. • Non-HE detergent is NOT recommended.

Troubleshooting

INFORMATION CODES

Information codes may be displayed to help you better understand what is occurring with your Washer.

Code Symbol	Meaning	Solution
dc	Unbalanced load prevented your Washer from spinning.	Redistribute the load, press the Cycle Selector dial.
dL	Door is unlocked when Washer is running.	Press the Power button to turn off your Washer, then restart the cycle. If the code reappears, call for service. See below.
dS	Door is open when Washer is running.	Close the door tightly and restart the cycle. If the code reappears, call for service. See below.
FL	Your Washer failed to lock the door.	Close the door tightly and restart the cycle. If the code reappears, call for service. See below.
H-	Water temperature control problem. (Heater Control problem)	Call for service. See below.
LE	Your Washer has tried to fill but has not reached the proper water level.	Call for service. See below.
LO	The door will not unlock.	Make sure the door is firmly closed. Push the Power button to turn off your Washer, then turn it on again. If the code reappears, call for service. See below.
E3	Motor not running properly.	Restart the cycle pressing the Cycle Selector dial. If the code reappears, call for service. See below.
nd	Your washer is not draining. But, it can light up when the unit senses a brief restriction while draining.	Before calling for service, check the following. 1) Turn off the unit and turn it on again. 2) Select the Spin Only 3) Press the Start/Pause to drain the water. If it still does not drain, call for service.
nF	Your Washer has tried to fill but was unsuccessful.	Make sure the water faucets are open all the way. Check for kinked hoses. Check inlet screens on fill hoses.

Troubleshooting



































Code Symbol	Meaning	Solution
SI-	Problem with control.	Call for service. See below.
PF	Electric service was lost when Washer was running.	Restart the cycle by pressing the Cycle Selector dial.
OE	A fault is detected in the water level sensor.	Call for service
E2	Jammed Key.	Call for service
6E	Motor speed sensor problem.	Restart the cycle. If the code reappears, call for service, see below
8E	Temperature sensor problem.	Restart the cycle. If the code reappears, call for service, see below
3E	High current detected.	Restart the cycle. If the code reappears, call for service, see below
2E	High/Low voltage detected.	Restart the cycle. If the code reappears, call for service, see below
8E	Vibration sensor problem.	Restart the cycle. If the code reappears, call for service, see below
7E	SilverCare™ control problem	Restart the cycle. If the code reappears, call for service, see below.
SUDS	Too much suds is detected during the washing session. And, the unit is put on hold until the suds get reduced. Then, it will go back to the operation. When it finishes washing, End and SUDS codes will blink in turn.	To prevent it, cut down on detergents.

For any codes not listed above, call 1-800-726-7864 (1-800-SAMSUNG)

Appendix

FABRIC CARE CHART

The following symbols provide garment care directions without words. The care label will include, in order, four symbols: washing, bleaching, drying and ironing, or dry cleaning when necessary. The use of symbols ensures consistency among garment manufacturers of domestic and imported items. Follow care label directions to maximize garment life and reduce laundering problems.

Wash Cycle		Special Instructions		Warning Symbols for Laundering	
	Normal		Line Dry/ Hang to Dry		Do Not Wash
	Permanent Press/ Wrinkle Resistant/ Wrinkle Control		Drip Dry		Do Not Wring
	Gentle/Delicates		Dry Flat		Do Not Bleach
	Hand Wash	Heat Setting			Do Not Tumble Dry
Water Temperature**			High		No Steam (added to iron)
	Hot		Medium		Do Not Iron
	Warm		Low		
	Cold		Any Heat		
Bleach			No Heat/Air		
	Any Bleach (when needed)	Iron-Dry or Steam Temperatures			Line Dry/ Hang to Dry
	Only Non-Chlorine (color-safe) Bleach (when needed)		High		Drip Dry
	Tumble Dry Cycle		Medium		Dry Flat
Normal			Low		
	Permanent Press/ Wrinkle Resistant/ Wrinkle Control	Dryclean			For machine-washable wool. Loads should be under 8 pounds.
	Gentle/ Delicates		Dry Clean		
			Do Not Dry Clean		

** The dot symbols represent appropriate wash water temperatures for various items. The temperature range for Hot is 105° - 125° F/ 41° - 52°C, for Warm 85° - 105° F/ 29° - 41° C and for Cold 60° - 85° F/ 16° - 29° C. (Wash water temperature must be a minimum of 60° F/ 16°C for detergent activation and effective cleaning.)

The clothes Washer may not ensure these temperatures because the actual water temperatures entering your Washer are dependent on water heater settings and regional water supply temperatures. For example, cold water entering the home in the northern states during winter may be 40° F/ 4° C which is too cold for effective cleaning. The water temperature in this situation will need to be adjusted by selecting a warm setting, adding some hot water to the MAX FILL line or using your Washer's heating option, if available.

Appendix

HELPING THE ENVIRONMENT

- Your Washer is manufactured from recyclable materials. If you decide to dispose of it, please observe local waste disposal regulations. Cut off the power cord so that the appliance cannot be connected to a power source.
Remove the door so that animals and small children cannot get trapped inside the appliance.
- Do not exceed the detergent quantities recommended in the detergent manufacturers' instructions.
- Use stain removal products and bleaches before the wash cycle only when strictly necessary.
- Save water and electricity by only washing full loads (the exact amount depends upon the program used).
- Use SilverCare™ instead of Hot Water Sanitization to save energy.

DECLARATION OF CONFORMITY

This appliance complies with UL2157.

SPECIFICATION

TYPE	FRONT LOADING WASHER			
DIMENSION	Div	Inches (cm)	Div	Inches (cm)
	A. Height - Overall	38" (96.5)	C. Depth with door open 90°	49" (124.5)
	B. Width	27" (68.6)	D. Depth	30.25" (77.0)
WATER PRESSURE			50 kPa ~ 800 kPa	
WEIGHT			89.9 kg	
HEATER RATING			3.29 Cu.ft	
POWER CONSUMPTION	WASHING		120 V	226W
	WASHING AND HEATING		120 V	997W
	SPIN		120 V	379W
	DRAIN		120 V	41W
SPIN REVOLUTION	WF326 *		1200rpm	
	WF316 *, WF317*		1100rpm	
	WF306 *, WF307*		1000rpm	
	WF206 *, WF207*		1000rpm	

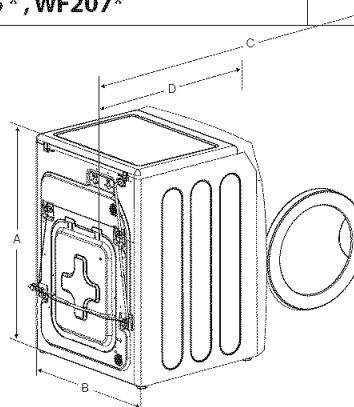

Appendix

CYCLE CHART

WF326***

	Functions													Options						Time			
	Temp					Spin					Soil Level			Delay Start	Extra Wash	Extra Rinse	My Cycle	Pre-wash	Extra Spin		Silver-Care™		
	EH/C	H/C	W/W	W/C	C/C	EH	H	M	L	NS	H	N	L										
Heavy Duty		✓	✓	✓	✓	✓	✓	✓	✓	✓	✓	✓	✓	✓	✓	✓	✓	✓	✓	✓	✓	92	
Normal		✓	✓	✓	✓	✓	✓	✓	✓	✓	✓	✓	✓	✓	✓	✓	✓	✓	✓	✓	✓	53	
Whites		✓	✓	✓	✓	✓	✓	✓	✓	✓	✓	✓	✓	✓	✓	✓	✓	✓	✓	✓	✓	62	
Perm Press			✓	✓	✓		✓	✓	✓	✓	✓	✓	✓	✓	✓	✓	✓	✓	✓	✓	✓	47	
Delicates/ Hand Wash			✓	✓	✓				✓	✓	✓	✓	✓	✓	✓						✓	41	
Wool 					✓				✓	✓		✓		✓								57	
Quick Wash		✓	✓	✓	✓	✓	✓	✓	✓	✓	✓	✓	✓	✓			✓	✓				✓	35
Towels		✓	✓	✓	✓	✓	✓	✓	✓	✓	✓	✓	✓	✓	✓	✓	✓	✓	✓	✓	✓	✓	66
Sanitize	✓					✓	✓	✓	✓	✓	✓	✓	✓	✓	✓	✓	✓	✓	✓	✓	✓	112	
Bedding			✓	✓	✓			✓	✓	✓	✓	✓	✓	✓	✓	✓	✓	✓	✓	✓	✓	✓	71
Active Wear			✓	✓	✓		✓	✓	✓	✓	✓	✓	✓	✓	✓		✓					✓	51
Eco Wash		✓	✓	✓	✓	✓	✓	✓	✓	✓	✓	✓	✓	✓	✓	✓	✓	✓	✓	✓	✓	✓	47
Rinse + Spin					✓	✓	✓	✓	✓	✓					✓		✓	✓			✓	✓	20
Spin Only						✓	✓	✓	✓	✓					✓			✓			✓		11

Appendix

WF206***, WF207***

	Functions											Options			Time
	Temp				Spin				Soil Level			Delay Start	Extra Wash	Extra Rinse	
	H/C	W/W	W/C	C/C	H	M	L	NS	H	N	L				
Heavy Duty	✓	✓	✓	✓	✓	✓	✓	✓	✓	✓	✓	✓	✓	✓	67
Normal	✓	✓	✓	✓	✓	✓	✓	✓	✓	✓	✓	✓	✓	✓	53
Whites	✓	✓	✓	✓	✓	✓	✓	✓	✓	✓	✓	✓	✓	✓	62
Perm Press		✓	✓	✓	✓	✓	✓	✓	✓	✓	✓	✓	✓	✓	47
Towels	✓	✓	✓	✓	✓	✓	✓	✓	✓	✓	✓	✓	✓	✓	66
Rinse + Spin				✓	✓	✓	✓	✓				✓		✓	20
Spin Only					✓	✓	✓	✓				✓			11

Appendix

WF316***, WF317***

	Functions													Options					Time		
	Temp					Spin					Soil Level			Delay Start	Extra Wash	Extra Rinse	My Cycle	Pre-wash		Silver-Care™	
	EH/C	H/C	W/W	W/C	C/C	EH	H	M	L	NS	H	N	L								
Heavy Duty		✓	✓	✓	✓	✓	✓	✓	✓	✓	✓	✓	✓	✓	✓	✓	✓	✓	✓	92	
Normal		✓	✓	✓	✓	✓	✓	✓	✓	✓	✓	✓	✓	✓	✓	✓	✓	✓	✓	53	
Whites		✓	✓	✓	✓	✓	✓	✓	✓	✓	✓	✓	✓	✓	✓	✓	✓	✓	✓	62	
Perm Press			✓	✓	✓		✓	✓	✓	✓	✓	✓	✓	✓	✓	✓	✓	✓	✓	47	
Delicates/ Hand Wash			✓	✓	✓				✓	✓	✓	✓	✓	✓	✓				✓	41	
Wool 					✓				✓	✓		✓		✓				✓		57	
Quick Wash		✓	✓	✓	✓	✓	✓	✓	✓	✓	✓	✓	✓	✓	✓		✓	✓		✓	35
Towels		✓	✓	✓	✓	✓	✓	✓	✓	✓	✓	✓	✓	✓	✓	✓	✓	✓	✓	✓	66
Sanitize	✓					✓	✓	✓	✓	✓	✓	✓	✓	✓	✓	✓	✓	✓	✓	✓	112
Bedding			✓	✓	✓			✓	✓	✓	✓	✓	✓	✓	✓	✓	✓	✓	✓	✓	71
Rinse + Spin					✓	✓	✓	✓	✓	✓					✓		✓	✓		✓	20
Spin Only						✓	✓	✓	✓	✓					✓			✓			11

Appendix

306BHW , WF307***

	Functions												Options				Time	
	Temp					Spin				Soil Level			Delay Start	Extra Wash	Extra Rinse	SilverCare™ (306BHW Only)		
	EH/C	H/C	W/W	W/C	C/C	H	M	L	NS	H	N	L						
Heavy Duty		✓	✓	✓	✓	✓	✓	✓	✓	✓	✓	✓	✓	✓	✓	✓	✓	67
Normal		✓	✓	✓	✓	✓	✓	✓	✓	✓	✓	✓	✓	✓	✓	✓	✓	53
Whites		✓	✓	✓	✓	✓	✓	✓	✓	✓	✓	✓	✓	✓	✓	✓	✓	62
Perm Press			✓	✓	✓	✓	✓	✓	✓	✓	✓	✓	✓	✓	✓	✓	✓	47
Delicates/ Hand Wash			✓	✓	✓			✓	✓	✓	✓	✓	✓	✓		✓	✓	41
Wool 					✓			✓	✓			✓		✓				57
Quick Wash		✓	✓	✓	✓	✓	✓	✓	✓	✓	✓	✓	✓	✓		✓	✓	35
Towels		✓	✓	✓	✓	✓	✓	✓	✓	✓	✓	✓	✓	✓	✓	✓	✓	66
Sanitize	✓					✓	✓	✓	✓	✓	✓	✓	✓	✓	✓	✓	✓	112
Bedding			✓	✓	✓		✓	✓	✓	✓	✓	✓	✓	✓	✓	✓	✓	71
Rinse + Spin					✓	✓	✓	✓						✓		✓	✓	20
Spin Only						✓	✓	✓	✓					✓				11

Appendix

SAMSUNG SILVERCARE™ WASHER

LIMITED WARRANTY TO ORIGINAL PURCHASER

This SAMSUNG brand product, as supplied and distributed by SAMSUNG ELECTRONICS AMERICA, INC. (SAMSUNG) and delivered new, in the original carton to the original consumer purchaser, is warranted by SAMSUNG against manufacturing defects in materials and workmanship for a limited warranty period of:

One (1) Year All Parts and Labor, Two (2) Years Control Board Parts, Five (5) Years Motor, Three Thousand (3,000) cycles or Ten (10) Years, whichever comes first for Silver Plates, and Lifetime Stainless Tub

One (1) Year All Parts and Labor, Two (2) Years Control Board Parts, Five (5) Years Motor, Three Thousand (3,000) cycles or Ten (10) Years, whichever comes first for Silver Plates, and Lifetime Stainless Tub

This limited warranty begins on the original date of purchase, and is valid only on products purchased and used in the United States. To receive warranty service, the purchaser must contact SAMSUNG for problem determination and service procedures. Warranty service can only be performed by a SAMSUNG authorized service center. The original dated bill of sale must be presented upon request as proof of purchase to SAMSUNG or SAMSUNG's authorized service center. SAMSUNG will provide in-home service during the warranty period at no charge, subject to availability within the contiguous United States. In-home service is not available in all areas.

To receive in-home service, product must be unobstructed and accessible to the service agent. If service is not available, SAMSUNG may elect to provide transportation of the product to and from an authorized service center.

SAMSUNG will repair, replace, or refund this product at our option and at no charge as stipulated herein, with new or reconditioned parts or products if found to be defective during the limited warranty period specified above. All replaced parts and products become the property of SAMSUNG and must be returned to SAMSUNG. Replacement parts and products assume the remaining original warranty, or ninety (90) days, whichever is longer.

This limited warranty covers manufacturing defects in materials and workmanship encountered in normal, noncommercial use of this product and shall not apply to the following: damage that occurs in shipment; delivery and installation; applications and uses for which this product was not intended; altered product or serial numbers; cosmetic damage or exterior finish; accidents, abuse, neglect, fire, water, lightning, or other acts of nature or God; use of products, equipment, systems, utilities, services, parts, supplies, accessories, applications, installations, repairs, external wiring or connectors not supplied or authorized by SAMSUNG that damage this product or result in service problems; incorrect electrical line voltage, fluctuations and surges; customer adjustments and failure to follow operating instructions, maintenance and environmental instructions that are covered and prescribed in the instruction book; product removal and reinstallation; problems caused by pest infestations. This limited warranty does not cover problems resulting from incorrect electric current, voltage or supply, light bulbs, house fuses, house wiring, cost of a service call for instructions, or fixing installation errors. SAMSUNG does not warrant uninterrupted or error-free operation of the product.

Appendix

EXCEPT AS SET FORTH HEREIN, THERE ARE NO WARRANTIES ON THIS PRODUCT EITHER EXPRESS OR IMPLIED, AND SAMSUNG DISCLAIMS ALL WARRANTIES INCLUDING, BUT NOT LIMITED TO, ANY IMPLIED WARRANTIES OF MERCHANTABILITY, INFRINGEMENT OR FITNESS FOR A PARTICULAR PURPOSE. NO WARRANTY OR GUARANTEE GIVEN BY ANY PERSON, FIRM, OR CORPORATION WITH RESPECT TO THIS PRODUCT SHALL BE BINDING ON SAMSUNG. SAMSUNG SHALL NOT BE LIABLE FOR LOSS OF REVENUE OR PROFITS, FAILURE TO REALIZE SAVINGS OR OTHER BENEFITS, OR ANY OTHER SPECIAL, INCIDENTAL OR CONSEQUENTIAL DAMAGES CAUSED BY THE USE, MISUSE, OR INABILITY TO USE THIS PRODUCT, REGARDLESS OF THE LEGAL THEORY ON WHICH THE CLAIM IS BASED, AND EVEN IF SAMSUNG HAS BEEN ADVISED OF THE POSSIBILITY OF SUCH DAMAGES.

NOR SHALL RECOVERY OF ANY KIND AGAINST SAMSUNG BE GREATER IN AMOUNT THAN THE PURCHASE PRICE OF THE PRODUCT SOLD BY SAMSUNG AND CAUSING THE ALLEGED DAMAGE. WITHOUT LIMITING THE FOREGOING, PURCHASER ASSUMES ALL RISK AND LIABILITY FOR LOSS, DAMAGE, OR INJURY TO PURCHASER AND PURCHASER'S PROPERTY AND TO OTHERS AND THEIR PROPERTY ARISING OUT OF THE USE, MISUSE, OR INABILITY TO USE THIS PRODUCT. THIS LIMITED WARRANTY SHALL NOT EXTEND TO ANYONE OTHER THAN THE ORIGINAL PURCHASER OF THIS PRODUCT, IS NONTRANSFERABLE AND STATES YOUR EXCLUSIVE REMEDY.

Some states do not allow limitations on how long an implied warranty lasts, or the exclusion or limitation of incidental or consequential damages, so the above limitations or exclusions may not apply to you. This warranty gives you specific rights, and you may also have other rights, which vary from state to state.

**To obtain warranty service, please contact SAMSUNG at:
SAMSUNG ELECTRONICS AMERICA, INC. – CONSUMER ELECTRONICS CUSTOMER SERVICE
400 Valley Road, Suite 201, Mt. Arlington, NJ 07856
1-800-SAMSUNG (1-800-726-7864)
www.samsung.com**



Contact SAMSUNG WORLD WIDE

If you have any questions or comments relating to Samsung products, please contact the SAMSUNG customer care center.

Samsung Electronics America, Inc.

1-800-SAMSUNG (726-7864)

www.samsung.com

