

Miele

HONEYCOMB CARE 

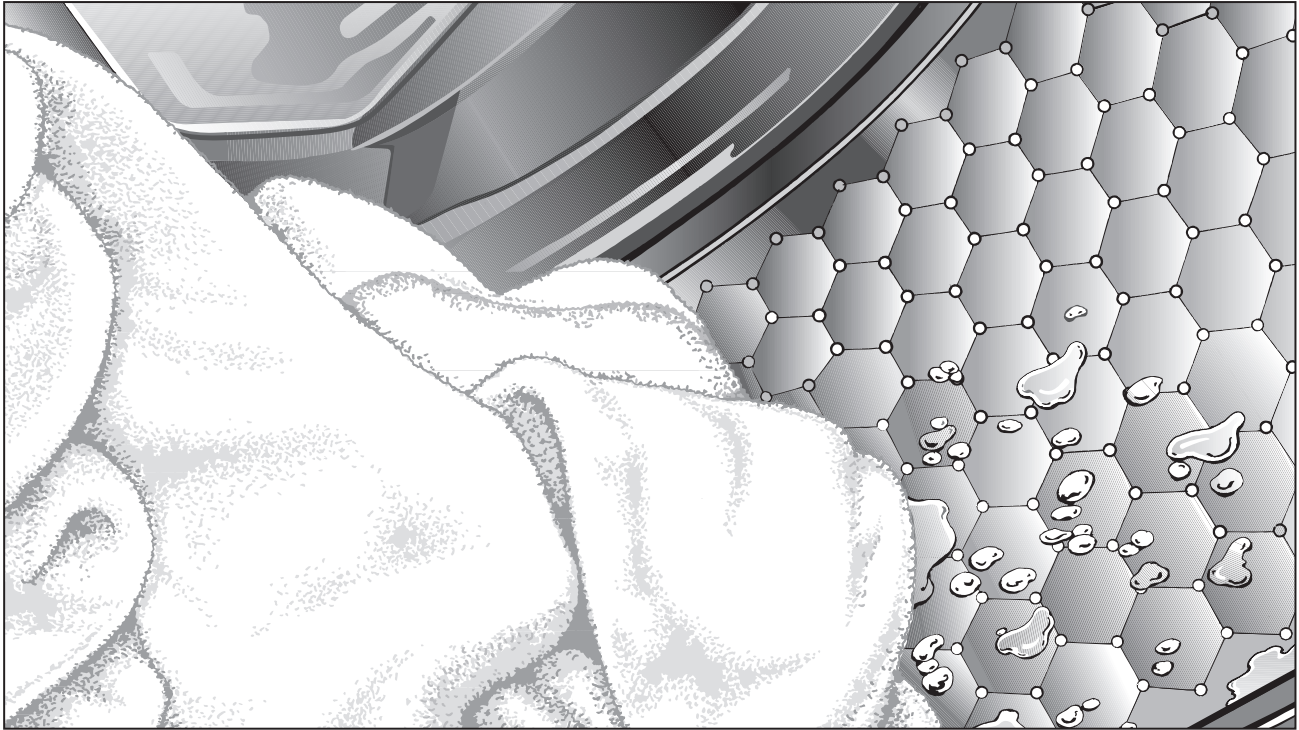

Operating instructions Washer-dryer WT 2780 WPM

To avoid the risk of accidents
or damage to the machine
it is **essential** to read
these instructions before it is
installed and used for the first time.

en - GB

M.-Nr. 09 442 060

Caring for the environment

Disposal of the packing material

The transport and protective packing has been selected from materials which are environmentally friendly for disposal and can normally be recycled.

Ensure that any plastic wrappings, bags etc. are disposed safely and kept out of the reach of babies and young children. Danger of suffocation!

Rather than just throwing these materials away, please ensure they are offered for recycling.

Disposal of your old machine

Electrical and electronic machines often contain materials which, if handled or disposed of incorrectly, could be potentially hazardous to human health and to the environment. They are, however, essential for the correct functioning of your machine. Please do not therefore dispose of it with your household waste.

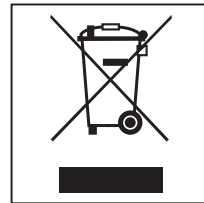

Please dispose of it at your local community waste collection / recycling centre or contact your Dealer for advice. Ensure that it presents no danger to children while being stored for disposal.

It should be unplugged or disconnected from the mains electricity supply by a competent person.

Caring for the environment	2
Warning and Safety instructions	6
Guide to the machine	14
Control panel	14
Display	15
Use.	15
Before using for the first time	16
Calibrating the load size sensor to zero	17
Washing and drying environmentally and economically	18
WASHING	19
Short instructions	19
Separate washing	19
Extra options	24
Short	24
Water plus.	24
Stains	24
Further extras.	24
Extra quiet.	24
Extra rinse.	25
Pre-wash.	25
Soak	25
Rinse hold.	25
Adding or removing laundry after a programme has started	25
Final spin speed	26
Rinse and interim spin	26
To omit the final spin (Rinse hold)	26
To omit the spin between rinses and the final spin	26
Programme chart	27
Programme sequence	31
Detergent.	33
Water softeners.	34
Washing with several components.	34
Fabric conditioner and liquid starch.	35
Colour run and dye removers/dyes	35
DRYING	36
Separate drying	36

Contents

Extra options	39
Low temperature.	39
Thermospin.	39
Extra quiet.	39
Adding or removing laundry after a programme has started	40
Programme chart	41
WASHING AND DRYING	47
Washing and drying in a continuous sequence	47
After each washing or drying programme.	48
Rinse out fluff programme	49
Changing the programme sequence	50
To cancel a programme	50
Interrupting a programme.	50
Changing a programme	50
Safety lock	51
Delay start.	52
Cleaning and care	53
Cleaning the machine	53
Cleaning the filter in the water inlet	55
Problem solving guide	56
The programme does not start	56
A fault message appears in the display	57
Problems with the load size indicator	58
General problems	59
An unsatisfactory wash result	60
An unsatisfactory drying result	61
The drum door cannot be opened by pressing the <i>Door</i> button.	62
Opening the drum door in the event of a blocked drain outlet and/or power failure	63
After sales service	65
Future updates (PC)	65
Guarantee.	65
Optional accessories	65
Installation and connection	66
Front view.	66
Rear view	67

Contents

Installation surface	68
Installing the washer-dryer	68
Removing the transit bars	68
Levelling the machine	70
Screwing out and adjusting the feet	71
Building under a continuous worktop / in a kitchen run	71
The Miele water protection system	72
Connection to the water supply	73
Connection to the drainage system	74
Electrical connection U.K.	75
Consumption data	76
Notes for test institutes:	76
Technical data	77
Settings menu	78
Language 	78
Buzzer	78
Time	79
Temperature unit	79
Brightness / Contrast	79
Standby display	79
Keypad tone	79
Lock code	80
Memory	80
Longer pre-wash Cottons	81
Gentle action	81
Suds cooling	81
Distribution controller	81
Drying levels	82
Extended cool down	82
Anti-crease	82
Optional accessories	83
CareCollection	83

Warning and Safety instructions

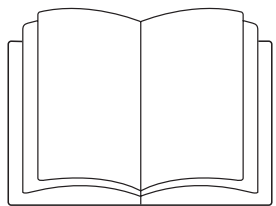

► It is **essential** to read the operating instructions.

This washer-dryer conforms to current safety requirements. Inappropriate use can, however, lead to personal injury and damage to property.

To avoid the risk of accidents and damage to the washer-dryer, please read these instructions carefully before using it for the first time. They contain important information on its installation, safety, use and maintenance.

Keep these instructions in a safe place and ensure that new users are familiar with the content. Pass them on to any future owner.

Correct application

► This washer-dryer is not designed for commercial use. It is intended for use in domestic households and in similar working and residential environments.

- It must only be used as a domestic appliance to
- wash items which are specified by the manufacturer as being washable on the care label.
 - dry items which have been washed in a water solution and which are marked on the manufacturer's care label as being suitable for tumble drying. If using dry cleaning kits, do so at your own risk, and follow the instructions provided on the packaging.

Any other usage is not supported by the manufacturer and could be dangerous. Miele cannot be held liable for damage resulting from incorrect or improper use or operation.

Warning and Safety instructions

- ▶ The washer-dryer is not intended for outdoor use.
- ▶ The washer-dryer can only be used by people with reduced physical, sensory or mental capabilities, or lack of experience and knowledge, if they are supervised whilst using it, or have been shown how to use it in a safe way and understand the hazards involved.

Safety with children

- ▶ Children under 8 years of age must be kept away from the washer-dryer unless they are constantly supervised.
- ▶ Children 8 years and older may only use the washer-dryer without supervision if they have been shown how to do so in a safe way and understand the hazards involved.
- ▶ Children must not be allowed to clean or maintain the washer-dryer unsupervised.
- ▶ The washer-dryer is not a toy! To prevent the risk of injury, do not allow children to play on or near it or to play with the controls.

Warning and Safety instructions

Technical safety

▶ Before setting up the washer-dryer, check it for any externally visible damage.

Do not install or use a damaged machine.

▶ Before connecting the washer-dryer, ensure that the connection data on the data plate (voltage and connected load) match the mains electricity supply. If in any doubt, consult a qualified electrician.

▶ The electrical safety of this washer-dryer can only be guaranteed when correctly earthed. It is most important that this basic safety requirement is observed and regularly tested, and where there is any doubt the household wiring system should be inspected by a qualified electrician. The manufacturer cannot be held liable for the consequences of an inadequate earthing system (e.g. electric shock).

▶ Do not connect the washer-dryer to the mains electricity supply by an extension lead. Extension leads do not guarantee the required safety of the machine (e.g. danger of overheating).

▶ Unauthorised repairs could result in unforeseen dangers for the user, for which the manufacturer cannot accept liability. Repairs should only be undertaken by a Miele approved service technician, otherwise any subsequent damage will not be covered by the guarantee.

Warning and Safety instructions

- ▶ The washer-dryer must be isolated from the electricity supply in the event of a fault and during installation, maintenance and repair work.
- ▶ The Miele "Water protection system" protects from water damage provided the following conditions have been met:
 - the washer-dryer is correctly plumbed in and connected to the electricity supply.
 - if a fault has been identified, the washer-dryer must be examined by a competent person before further use, and repaired if necessary.
- ▶ Faulty components must only be replaced by genuine Miele original spare parts. Only when these parts are fitted can the safety standards of the machine be guaranteed.
- ▶ If the electrical connection cable is faulty it must only be replaced by a Miele approved service technician to protect the user from danger.
- ▶ The washer-dryer must not be used in a non-stationary location (e.g. on a ship).
- ▶ Do not make any alterations to the washer-dryer, unless authorised to do so by Miele.
- ▶ In areas which may be subject to infestation by cockroaches or other vermin, pay particular attention to keeping the washer-dryer and its surroundings in a clean condition at all times. Any damage which may be caused by cockroaches or other vermin will not be covered by the guarantee.

Warning and Safety instructions

Correct use

- ▶ Do not install your washer-dryer in rooms where temperatures below freezing may occur. Frozen hoses may burst or split. The reliability of the electronic control unit may be impaired at temperatures below freezing point.
- ▶ Before using the washer-dryer for the first time, check that the transit bars at the rear of the machine have been removed (see "Installation and connection - Removing the transit bars"). During spinning, a transit fitting which is still in place may result in damage to both the washer-dryer and adjacent furniture or appliances.
- ▶ Turn off the stopcock if the washer-dryer is to be left for any length of time (e.g. holiday), especially if there is no floor drain (gully) in the immediate vicinity.
- ▶ Flooding danger. If hooking the drain hose into a wash basin, check that the water can drain off quickly enough to prevent the sink from overflowing. Make sure that the drain hose is secure, so that the force of the water flowing out of the hose does not dislodge it.
- ▶ Take care to ensure that foreign objects (e.g. nails, pins, coins, paper clips) do not find their way into the washer-dryer with the laundry. These may damage components of the machine (e.g. suds container, drum), which in turn can result in damage to the laundry.
- ▶ If the correct amount of detergent is dispensed, the washer-dryer should not need to be descaled. If, however, you do wish to descale the machine only use proprietary non-corrosive descaling agents and strictly observe the instructions on the packaging. A special descaling agent is available to order from Miele. Follow the instructions for use on the packaging carefully.

Warning and Safety instructions

► To prevent the risk of fire, the following must **not** be dried in this washer-dryer:

- items which have not been washed.
- items, such as workwear, which have not been thoroughly cleaned and which are still soiled with grease, oil or other deposits (such as cosmetics, lotions etc).
If items have not been thoroughly cleaned there is a danger that these might self-ignite when heated, even after they have been removed from the washer-dryer at the end of the programme.
- items (e.g. mops and floor cloths) which have been treated with inflammable cleaning agents or which contain residues of acetone, alcohol, benzene, petrol, stain remover, turpentine, wax and wax remover or other chemicals.
- items which have been splashed with hair lacquer, hair spray, nail varnish remover or similar substances.

When washing such heavily soiled items, ensure that you use sufficient detergent and select a high temperature. If in doubt, wash the items several times.

► To prevent the risk of fire, the following must not be tumble dried:

- items which have been cleaned using chemicals (e.g. professional dry-cleaning agents).
- fabrics which contain a large proportion of rubber, foam rubber or rubber-like materials. For example, products made from latex foam rubber, shower caps, waterproof textiles, rubberised articles and items of clothing and pillows with foam rubber filling.
- damaged items which contain padding or fillings (e.g. pillows, jackets). When damaged, the filling can get out with the risk of igniting in the washer-dryer.

Warning and Safety instructions

- ▶ In many programmes, the heating phase is followed by a cooling down phase to ensure that the items are not too hot to handle when you remove them (this also avoids the danger of the laundry self-igniting). The programme is not finished until the cooling down phase has been completed.
As soon as the programme has finished, remove all laundry from the drum.
- ▶ Warning: Do not switch the washer-dryer off before the drying programme has finished. If this is done, the laundry must be hung up or spread out to cool it down.
- ▶ Fabric conditioner and similar products must be used according to the instructions on the manufacturer's packaging.
- ▶ Only use dyes specified by the manufacturer as being suitable for use in a domestic washer-dryer. Always observe the manufacturer's instructions carefully.
- ▶ Colour run and dye removers contain sulphur compounds which can cause damage such as corrosion. Do not use these products in this washer-dryer.
- ▶ Make sure that any dispensing balls etc. are removed from laundry before the drying programme. These dispensers can melt during the drying programme and cause damage to the washer-dryer and the laundry. Do not use liquid dispenser balls or similar if you are planning to wash and then dry in one continuous sequence.
- ▶ Textiles which have been pre-treated in solvent based cleaning agents must be thoroughly rinsed in clean water before being washed in the washer-dryer.

Warning and Safety instructions

- ▶ Do not use solvent based cleaning agents, e.g. those containing benzene, in this washer-dryer, as this may result in damage to component parts and create toxic fumes. Such agents also pose a fire and explosion hazard.
- ▶ Caution, the metal cap is hot after drying. Open the door wide after the drying cycle. Do not touch the metal cap located on the inside of the door glass. It will still be hot and could cause a burn.

Accessories

- ▶ Accessory parts may only be fitted when expressly approved by Miele. Using spare parts or accessories from other manufacturers will invalidate the guarantee, and Miele cannot accept liability.

Miele cannot be held liable for damage caused by non-compliance with these Warning and Safety instructions.

Display

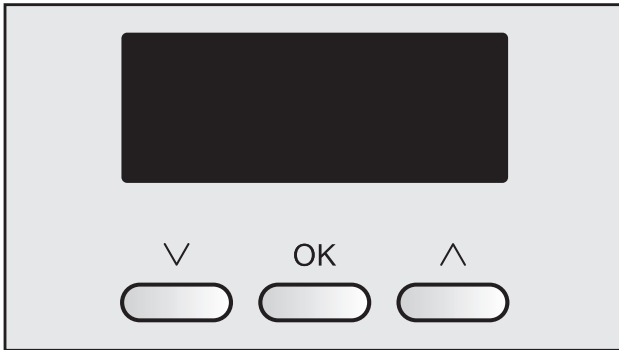

The display is operated using the **V**, **OK** and **^** buttons. The value or option currently selected will appear highlighted.

Press **button V** to decrease a value in the display or to scroll down to the next option.

Press **button ^** to increase a value in the display or to scroll up to the next option.

Press the **OK** button to confirm the value or option highlighted in the display.

With the programme selector at the *Further programmes / Settings* position, you can change display settings (see "Settings menu") and select the additional programmes (see "Programme chart").

The display is also used for selecting the wash temperature, spin speed, soak duration, delay start, safety lock and to cancel a programme.

Use

This washer-dryer can be used:

- **to wash separately**
Maximum load (depending on programme) 5.5 kg;
 - **to dry separately**
Maximum load (depending on programme) 3.0 kg;
- or
- **to wash and dry in a continuous sequence**
Maximum load (depending on programme) 3.0 kg;

Before using for the first time

Before using the machine for the first time ensure that it is correctly installed and connected. Also check that the drain filter is securely tightened to prevent the risk of water leakage during use. See "Installation and connection".

This washer-dryer has undergone a complete functional test at the factory and there will be some residual water in the drum from this process.

The washer-dryer has a sensor which measures the amount of laundry in the drum. This determines the amount of detergent required. To allow the load size indicator to function correctly, you must first run a wash programme without any laundry and without detergent.

- Open the stopcock.
- Press the  button.

If the machine is being switched on for the first time, the *Miele Willkommen* welcome screen will appear.

The welcome screen will not appear again once a programme lasting longer than 1 hour has been completed.

After a few seconds the display will change to show the screen for selecting your language.

Setting the language



- Use the \vee and \wedge buttons to select the language you want and confirm your selection by pressing the **OK** button.

Setting the time of day

The display for setting the time will then appear.

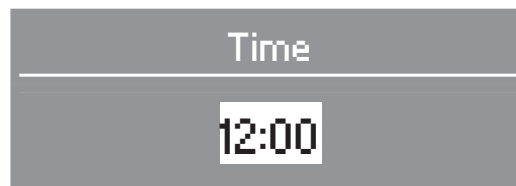

- Set the hour with the \vee and \wedge buttons and confirm your setting by pressing the **OK** button. Then do the same to set the minutes.

After you have confirmed the minute setting, the display will change to show the reminder to remove the transport bars.

Reminder to remove transport bars

 To avoid the risk of damage, the transport bars must be removed before the washer-dryer is used for the first time. See "Installation and connection" for instructions on how to do this.

- After removing the transport bars (if this has not already been done by your fitter) press the **OK** button.

Running your first programme

Your washer-dryer is now ready for the first programme to be run.

- Turn the programme selector to *Cottons*.
- Press the *Start/Stop* button.
- At the end of the programme switch the machine off.

After running the first programme, the load sensor has to be calibrated to zero (as you would with bathroom scales).

Calibrating the load size sensor to zero

- Switch the machine on.
- Open the drum door.
- Turn the programme selector to *Cottons*.
- Press and hold the *Load % / Detergent %* button in until the following message appears in the display:

Zero setting OK

- Switch the machine off.

The machine is now ready for use.

Washing and drying environmentally and economically

Energy and water consumption

- Water consumption and energy usage are determined by the size of the load.
To make the most out of your machine, load the maximum amount for the programme you are using.
- Use the *Automatic plus* and *Express 20* programmes for small loads.
- When smaller amounts of laundry are washed using the *Cottons* programmes, the automatic load recognition system will reduce the amount of water, time and energy used. This may mean that the time left shown in the display is adjusted during the course of the wash programme.
- Using the *Cottons 60°C* programme instead of the *Cottons 95°C* programme will give energy savings of between 35% and 45%. This is sufficient for most levels of soiling. For stubborn or old soiling use the *Soak* extra option.

Detergent

- Do not exceed the amounts of detergent recommended by the manufacturer on the packaging.
- Reduce the amount of detergent for smaller loads. Use the *Load % / Detergent %* button.

Choosing the correct extra option (Pre-wash, Soak, Short)

Select:

- A wash programme together with the *Short* extra option for light to normal soiling where there are no obvious marks.
- A wash programme without any extra options for normal to heavy soiling.
- A wash programme together with the *Soak* extra option for very heavily soiled laundry.
- The *Pre-wash* extra option for laundry with large amounts of dirt (e.g. dust, sand).

When drying straight after washing

Select a high spin speed for the wash programme, as well as for the Thermospin to save time and energy.

Short instructions

The headings numbered ①, ②, ③, . . . show the operating sequence and can be used as brief instructions.

Separate washing

① Sort the laundry

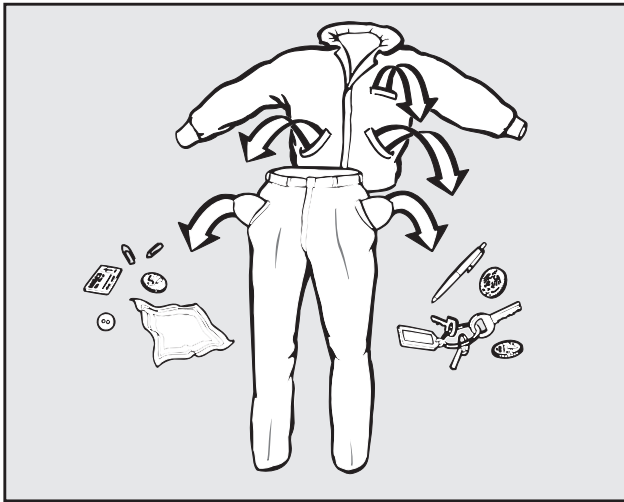

- Empty all pockets.

⚠ Foreign objects (e.g. nails, coins, paper clips, etc.) can cause damage to textiles and to components in the machine.

- Badly soiled areas, stains etc. should be cleaned as soon as possible, preferably whilst still fresh. Spillages should be carefully dabbed off using a soft, colourfast cloth. Do not rub!

Badly soiled areas can be pre-treated with liquid detergent, stain removers etc. first, following the manufacturer's instructions. You can also use the "Stains" extra option. With particularly stubborn stains ask your dry cleaner for advice.

⚠ Do not use solvent-based cleaning agents in this machine.

- Sort the laundry by colour and by care label. Most garments have a textile care label in the collar or side seam.

Curtains: Remove lead weights first or place in a laundry bag.

- Underwiring and collar stiffeners: Any loose wiring in bras, shirt collar stiffeners, etc. should be removed or sewn in.
- Close any zips, fasten hooks and eyes etc before washing.
- Wash light and dark coloured items separately.
- Fasten duvet covers, pillow cases etc. to prevent small items from being rolled up inside them.

Do not wash items in this machine which are specified by the manufacturer as **not washable** on the care label.

WASHING

2 Switch the machine on

The interior drum lighting will come on.

The drum lighting will go out automatically after five minutes. Press the Door button to switch the drum lighting back on again.

3 Select a programme

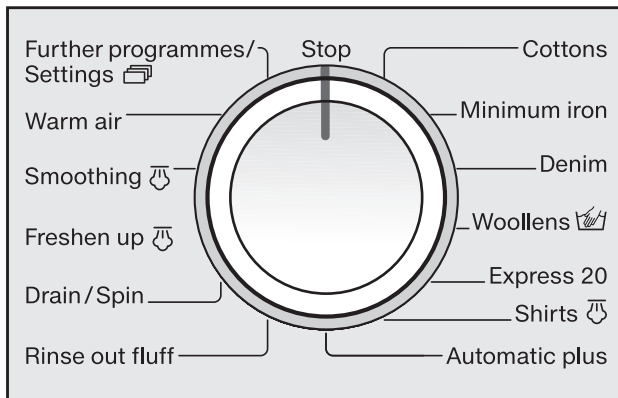

- Select the programme you want.

The programme selected will appear in the display.



Further programmes:

Turn the programme selector to *Further programmes/Settings* to display a list of other programmes that the machine has to offer.



- Use the V or ^ button to highlight the programme you wish to select and

confirm your selection by pressing the **OK** button.

- Press the *Washing/Drying* button repeatedly until **only** the Washing indicator light is lit up.

The *Drying* indicator light must not be lit up as well as this would mean that the washing programme would be followed immediately by the relevant drying programme.



- Use the V or ^ button to alter the temperature. Press the **OK** button to confirm the temperature selected and move on to the spin speed option.



- Use the V or ^ button to alter the spin speed or to select *No spin* (No).

4 Select Extra option(s)

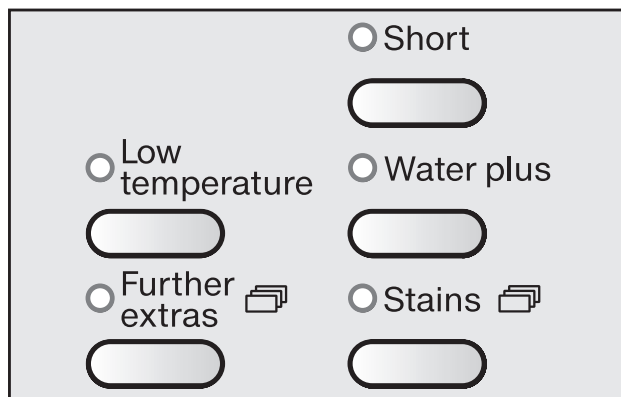

- Press the appropriate button to select *Short* or *Water plus*. The relevant indicator light will come on.
- Then select any *Further extras* or the *Stains* option:

Example:

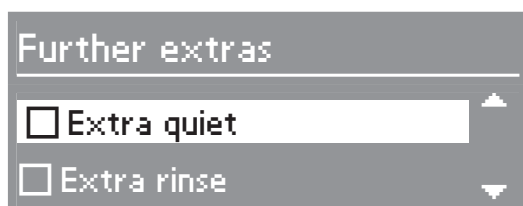

- Use the ∇ or \blacktriangle button to highlight the Extra you wish to select and confirm your selection by pressing the **OK** button.

A tick will appear to show which Extra has been selected. If you wish to deselect the Extra with a tick against it press the **OK** button again.

Press the *Further extras* button again to come out of the *Extras* menu.

You can only select extra options which are compatible with the programme being used. If the *Extras* or *Stains* option cannot be selected it is not compatible with the programme you are trying to use it with.

The *Low temperature* option is only available for a drying programme.

5 Load the drum

- Press the *Door* button to open the drum door.

The load size indicator display will appear.



The display shows the amount of laundry loaded in the drum as a % (in 25% steps) of the maximum load permissible for the programme selected.

- Unfold the laundry and load loosely into the drum. Mixing both large and small items gives better wash results and also helps distribute the load evenly during spinning.

The most efficient use of energy and water is achieved when a full load is washed. However, do not overload as this causes creases and reduces cleaning efficiency.

Make sure that no items are caught between the drum door and seal.

- Shut the door with a gentle swing.

WASHING

6 Add detergent

The detergent dispenser display will now appear.

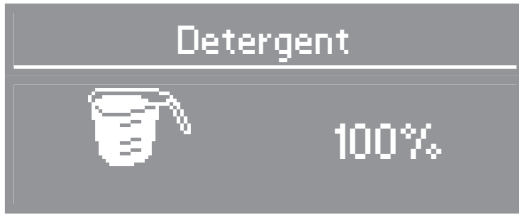

The percentage shown relates to the amount of detergent recommended by the manufacturer on the packaging.

40%	Add slightly less than half the recommended amount . . .
50%	Add half the recommended amount . . .
60%	Add slightly more than half the recommended amount . . .
75%	Add three quarters of the recommended amount . . .
100%	Add the recommended amount

You also need take the level of soiling and water hardness into account.

Too little detergent results in:

- Laundry not getting properly clean and with time it may become grey and hard to the touch.
- Greasy particles clinging to laundry.
- Limescale deposits on the heater elements.

Too much detergent results in:

- Excessive foam which causes a low level of agitation and poor wash, rinse and spin results.
- High water consumption (an additional rinse cycle will automatically switch in).

- A burden to the environment.

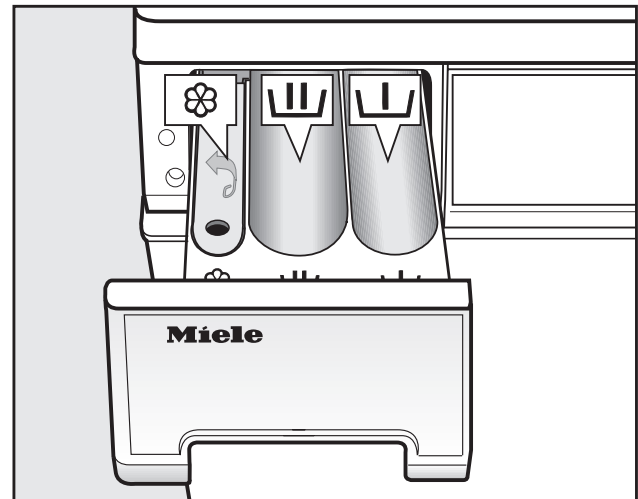

- Pull out the detergent drawer and add detergent to the compartments as follows:

 = Detergent for the pre-wash ($\frac{1}{3}$ of the total amount recommended).

 = Detergent for the main wash including Soak, if selected

 = Fabric conditioner or liquid starch

- Close the detergent drawer.

See "Detergent" for further information.

7 Select Delay start

If required please refer to "Delay start" for more information.

8 Start the programme

- Press the flashing *Start/Stop* button.

The estimated programme duration will start counting down in one minute steps. During the first few minutes the machine measures how much water is being absorbed by the laundry. The programme duration may be longer or shorter depending on this absorbency rate.

The programme sequence is also shown in the display. The washer-dryer shows you when each section of the programme is reached.

The drum lighting switches off once the programme has started.

9 Remove the laundry when the programme has finished

The anti-crease phase starts as soon as the programme finishes.

The machine will switch off automatically 15 minutes after the end of the anti-crease phase. You will need to press the ① button to switch it back on again.

- Turn the programme selector to the *Stop* position.
- Open the drum door and remove the laundry.

Check that all items have been removed from the drum. Items left in the drum could discolour other items in the next wash or become discoloured themselves.

Important: Always remove the laundry before switching the machine off. This is important to ensure that the load size indicator works correctly.

- Switch the machine off using the ① button.

See "After each washing or drying programme" in "WASHING AND DRYING" for further information.

After washing a full load

If you have washed a full load of laundry and you wish to dry the laundry in the washer-dryer afterwards you will have to remove half the load. Carry out the drying procedure in two batches.

WASHING

Extra options

You can use the *Extra option* buttons to augment the basic wash programmes.

Short

For light to normal soiling with no visible staining.

The duration of the main wash is reduced.

Water plus

The water level in the main wash and the rinses will be increased.

Stains

- Press the *Stains* button.

There is a choice of various types of stains for achieving the optimum wash results. With some stains, a tip about pre-treating the stain will appear in the display. You can select a maximum of three stains for a wash programme.

If the *Short* extra option has been selected, it will be deselected automatically.

Press the *Stains* button again to come out of the *Stains* sub-menu.

Further extras

- Press the *Further extras* button.

Select the *Further extras* you want.

Press the *Further extras* button again to come out of the *Extras* menu.

Extra quiet

If you want to use your machine to wash laundry during quiet periods, you can reduce the noise level. The buzzer will not sound.

If the *Extra quiet* extra option is selected, the machine will activate the *Rinse hold* extra option and not spin. The programme duration is longer.

To deactivate Rinse hold

- Press the *Further extras* button and use the \vee or \wedge button to select *Rinse hold*. To deactivate *Rinse hold* press the **OK** button.

The following will appear in the display.



Delay start can be used to delay the spin

Use Delay start to begin the final spin at a convenient time.

Extra rinse

This extra option introduces an extra rinse.

Pre-wash

For laundry with large amounts of dirt (e.g. dust, sand).

Soak

For heavily soiled items with protein stains.

A length of time of between 30 minutes and 6 hours can be chosen, in 30 minute periods, for the "Soak" process.

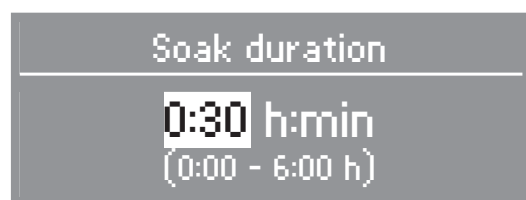

- Use the \vee or \wedge button to highlight the Soak duration you wish to use and confirm your selection by pressing the **OK** button.

To delete the soak duration

- Press the *Further extras* button and use the \vee or \wedge button to select *Soak*. To deactivate *Soak* press the **OK** button.

Rinse hold

The laundry will not be spun and will remain suspended in the final rinse water. This reduces creasing if the laundry is not going to be removed from the drum immediately after the end of the programme.

Adding or removing laundry after a programme has started

- Press the *Door* button to open the drum door.
- Add or remove items.
- Close the drum door.

The programme will continue automatically.

Please note:

Once a programme has started the machine cannot recognise any adjustment to the load.

For this reason, if laundry is added or removed after the start of a programme, the machine will always complete the programme cycle assuming a full load.

This can alter the programme running time shown in the display.

The door cannot be opened, if:

- the suds temperature is **above 55°C**.
- the water is above a certain level.
- the programme has reached the *Final spin* stage.
- the safety lock has been activated.

WASHING

Final spin speed

Programme	rpm
Cottons	1600
Minimum iron	1200
Denim	900
Woollens	1200
Express 20	1600
Shirts	600
Automatic plus	1200
Dark garments	1200
Delicates	600
Sportswear	1200
Trainers	1000
Outerwear	800
Proofing	1000
Soft toys	900
Hygiene	1600
First wash	1200
Silks	600
Pillows	1200
Curtains	600
Separate rinse	1600
Starch	1600
Drain / Spin	1600

You can reduce the final spin speed. However, you cannot select a final spin speed higher than that shown in the chart above.

Rinse and interim spin

There is a spin after the main wash and between the rinses. A reduction in the final spin speed will also reduce the interim spin speed. In some programmes, an additional rinse is introduced if a spin speed of less than 700 rpm is selected.

To omit the final spin (Rinse hold)

- Select the *Rinse hold* Extra.

– To start the final spin:

The machine will display the previously set spin speed. You can change this to a different spin speed if you wish. Start the final spin by pressing the *Start/Stop* button.

– To end the programme:

Press the *Door* button. The water will drain away. Press the *Door* button again to open the door.



















To omit the spin between rinses and the final spin

- Select the *No* ☺ option.

The laundry is not spun after the final rinse. The water will drain away and the machine will go straight into the anti-crease stage.











With some programmes an additional rinse is introduced if this setting is selected.

Programme chart

Cottons       *		cold to 95°C	Max. load 5.5 kg
Suitable for	Cotton, linen or cotton mix fabrics, e.g. T-shirts, underwear, table linen.		
Extra options	Short, Water plus, Stains, Extra quiet, Extra rinse, Pre-wash, Soak, Rinse hold		
Note for test institutes: Short programme: 3 kg load and <i>Short</i> extra option			
Minimum iron         *		cold to 60°C	Max. load 3.0 kg
Suitable for	Synthetics and mixed fibre garments as well as easy care cottons.		
Extra options	Short, Water plus, Stains, Extra quiet, Extra rinse, Pre-wash, Soak, Rinse hold		
Denim		cold to 60°C	Max. load 3.0 kg
Note	<ul style="list-style-type: none"> – Wash denim inside out. – Denim often contains excess dye and may run during the first few washes. Wash light and dark coloured items separately. 		
Extra options	Short, Stains, Extra quiet, Pre-wash, Soak, Rinse hold		
Woollens    *		cold to 40°C	Max. load 2.0 kg
Suitable for	Machine and hand-washable wool or wool blend garments. If the care label does not specify a temperature, wash using the cold setting.		
Extra options	Rinse hold		
Express 20   *		cold to 40°C	Max. load 3.0 kg
Suitable for	Small loads of lightly soiled cotton garments		
Extras	Water plus, Extra quiet, Extra rinse, Rinse hold; the <i>Short</i> option is activated automatically.		
Shirts		cold to 60°C	Max. load 1.5 kg
Note	<ul style="list-style-type: none"> – Pre-treat collars and cuffs if necessary. – Wash silk blouses and shirts in the <i>Silks</i> programme. 		
Extra options	Short, Water plus, Stains, Extra quiet, Extra rinse, Pre-wash, Soak, Rinse hold		

* Please note that the "buckets" represent garment care label symbols. See "Garment care label symbols".

WASHING



Automatic plus     *			cold to 40°C	Max. load 4.5 kg
Suitable for	Mixed loads of garments suitable for the <i>Cottons</i> and <i>Minimum iron</i> programmes. Sort according to colour.			
Note	The wash parameters are adjusted automatically in this programme to ensure the best possible care and wash results for each item.			
Extra options	Stains, Extra quiet, Rinse hold			
Dark garments			cold to 40°C	Max. load 3.0 kg
Suitable for	Dark garments made from cotton or mixed fibres.			
Note	Wash inside out.			
Extra options	Short, Water plus, Stains, Extra quiet, Pre-wash, Soak, Rinse hold			
Delicates       *			cold to 60°C	Max. load 1.5 kg
Suitable for	Delicate garments made of synthetic fibres, mixed fibres, rayon and easy care cottons.			
Note	Select <i>No</i> ☉ for items which crease easily.			
Extra options	Short, Stains, Extra quiet, Pre-wash, Soak, Rinse hold			
Sportswear			cold to 60°C	Max. load 2.0 kg
Suitable for	Sportswear such as singlets and leggings as well as microfibre and fleece garments.			
Note	<ul style="list-style-type: none"> – Do not use fabric conditioner. – Please observe the instructions on the wash care label. 			
Extra options	Short, Water plus, Stains, Extra quiet, Extra rinse, Pre-wash, Soak, Rinse hold			
Trainers			cold to 40°C	Max. 2 pairs of shoes
Suitable for	Trainers (do not use for leather shoes)			
Note	<ul style="list-style-type: none"> – Observe the manufacturer's care label. – Remove coarse soiling with a brush before washing. – Do not use fabric conditioner. – A pre-wash without detergent is carried out automatically to remove dust. 			
Extra options	Rinse hold; pre-wash is activated automatically.			

* Please note that the "buckets" represent garment care label symbols. See "Garment care label symbols".

WASHING

Outerwear		cold to 40°C	Max. load 2.0 kg
Suitable for	Outerwear made from membrane fabrics such as Gore-Tex [®] , SYMPATEX [®] , WINDSTOPPER [®] etc.		
Note	<ul style="list-style-type: none"> – Zip up jackets before washing. – Do not use fabric conditioner. 		
Extra options	Short, Water plus, Stains, Extra quiet, Extra rinse, Pre-wash, Soak, Rinse hold		
Proofing		40°C	Max. load 2.0 kg
Suitable for	Treating microfibre fabrics, skiwear, and table linen made from mainly synthetic fibres with a water and stain resistant finish.		
Note	<ul style="list-style-type: none"> – The items should be colour sorted and freshly laundered and spun or dried before proofing. – For optimum results the proofing agent should be heat-treated by drying the garment in the drying cycle or by ironing it. 		
Extra options	Extra quiet, Rinse hold		
Soft toys		cold to 40°C	Max. load 1.0 kg
Suitable for	Soft toys, specified as machine-washable by the manufacturer.		
Note	Do not wash soft toys stuffed with straw.		
Extra options	Stains, Extra quiet, Extra rinse, Rinse hold		
Hygiene		30 to 95°C	Max. load 5.5 kg
Suitable for	Cotton and linen fabrics which have been in direct contact with the skin, e.g. underwear, nappies, towelling, bed linen, pillow and mattress covers or where high standards of hygiene are required.		
Note	<ul style="list-style-type: none"> – If possible select a temperature above 40°C – Observe instructions given on the care label. 		
Extra options	Water plus, Stains, Extra quiet, Extra rinse, Pre-wash, Soak, Rinse hold		
First wash		cold to 40°C	Max. load 3.0 kg
Suitable for	New items made of cotton, towelling and polyester fabrics.		
Note	Use this programme to wash any chemical residues out of new items.		
Extra options	Water plus, Extra quiet, Extra rinse, Rinse hold		

WASHING

Silks 		cold to 30°C	Max. load 1.0 kg
Suitable for	Silks and other handwashable fabrics with no wool content		
Note	Place socks, tights, bras etc. in a washing bag.		
Extras	Water plus, Extra rinse, Rinse hold		
Pillows		cold to 95°C	2 pillows (40x80 cm) or 1 pillow (80x80 cm)
Suitable for	Washable pillows with feather, down or synthetic fillings.		
Note	– Please observe the instructions on the wash care label.		
Extras	Water plus, Stains, Extra quiet, Extra rinse, Rinse hold		
Curtains		cold to 40°C	Max. load 1.0 kg
Suitable for	Curtains, including net curtains, specified as machine-washable by the manufacturer.		
Note	<ul style="list-style-type: none"> – For curtains which crease easily, reduce the spin speed or deselect the spin. – Remove weights from curtains. – A pre-wash without detergent is carried out automatically to remove dust. 		
Extras	Water plus, Stains, Extra quiet, Extra rinse, Rinse hold: Pre-wash is activated automatically.		
Separate rinse			Max. load 5.5 kg
Suitable for	Hand washed items which only need airing.		
Note	– Reduce the spin for items which crease easily.		
Extras	Extra quiet, Rinse hold		
Starch			Max. load 5.5 kg
Suitable for	Starching table cloths, serviettes and workwear		
Note	<ul style="list-style-type: none"> – The laundry should be washed but not treated with fabric conditioner. – Reduce the spin for items which crease easily. 		
Extras	Extra quiet, Rinse hold		
Drain / Spin			Max. load 5.5 kg
Note	<ul style="list-style-type: none"> – Drain only: Select <i>No spin</i> . – Make sure you select the appropriate spin speed. 		

Programme sequence

	Main wash		Rinses		Spin	
	Water level	Wash rhythm	Water level	Rinses	Interim spin	Final spin
Cottons		Ⓐ		2-4 ¹⁾²⁾	✓	✓
Minimum iron		Ⓒ		2-3 ³⁾	✓	✓
Denim		Ⓒ		3	–	✓
Woollens		Ⓕ		2	✓	✓
Express 20		Ⓑ		2-3 ³⁾	✓	✓
Shirts		Ⓒ		2	–	✓
Automatic plus		ⒶⒷⒸ		2-3 ³⁾	✓	✓
Dark garments		Ⓑ		3	✓	✓
Delicates		Ⓓ		3	–	✓
Sportswear		Ⓒ		2	✓	✓
Trainers ⁶⁾		Ⓔ		2	–	✓
Outerwear		Ⓓ		3	✓ ⁴⁾	✓
Proofing		Ⓓ	–	–	–	✓
Soft toys		Ⓒ		3	✓	✓
Hygiene		Ⓑ		3-4 ²⁾	✓	✓
First wash		Ⓑ		2	✓	✓
Silks		Ⓕ		2	–	✓
Pillows ⁵⁾		Ⓓ		3	–	✓
Curtains ⁶⁾		Ⓓ		3	–	✓
Separate rinse	–	–		2	–	✓
Starch		Ⓒ	–	–	–	✓

Please see next page for description of the symbols

WASHING

 = Low water level

 = Medium water level

 = High water level

Ⓐ = Intensive rhythm

Ⓑ = Normal rhythm

Ⓒ = Gentle rhythm

Ⓓ = Sensitive rhythm

Ⓔ = Ultra sensitive rhythm

Ⓕ = Handwash rhythm

This machine has fully electronic controls with automatic load recognition. It takes in the right amount of water required for the programme depending on the amount of laundry and its absorbency rate. This means that programme cycles and durations can vary.

The programme sequences outlined in the chart are based on the basic programme with a full load. Extra options which can be selected have not been taken into account.

The display shows the stage the programme has reached.

Special features in the programme sequences:

Anti-crease:

At the end of the programme, the drum continues to turn at intervals for up to 30 minutes to help prevent creasing.

Exception: There is no anti-crease phase in the *Woolens* programme.

The door can be opened and laundry removed at any time during the anti-crease phase.

1) A second rinse is carried out when a temperature of 60°C to 95°C has been selected. A third rinse is carried out when a temperature below 60°C is selected.

2) An third or fourth rinse is carried out if:

- there is too much foam in the drum
- a spin speed lower than 700 rpm has been selected
- No Ⓒ has been selected.

3) A third rinse is carried out if:

- No Ⓒ has been selected.

4) There is a spin only after the main wash.

5) Run-up to spin: A run-up to spin is carried out before the wash process begins to deflate the pillows.

6) Pre-wash: A pre-wash is carried out automatically to remove dust.

Detergent

	Universal detergent	Detergent for coloureds	Detergent for delicates	Specialist detergent	Proofing agent	Fabric conditioner
Cottons	X	X	–	–	–	X
Minimum iron	X	X	–	–	–	X
Denim ¹⁾	X	X	X	–	–	X
Woollens	–	–	–	X	–	X
Express 20 ¹⁾	X	X	–	–	–	X
Shirts	X	X	–	–	–	X
Automatic plus	X	X	–	–	–	X
Dark garments ¹⁾	X	X	X	–	–	X
Delicates	X	X	X	–	–	X
Sportswear ¹⁾	X	X	–	X	–	–
Trainers ¹⁾	–	X	–	–	–	–
Outerwear ¹⁾	–	–	X	X	–	–
Proofing ²⁾	–	–	–	–	X	–
Soft toys ¹⁾	–	X	X	–	–	X
Hygiene ³⁾	X	–	–	–	–	X
First wash	X	X	–	–	–	X
Silks	–	–	–	X	–	X
Pillows ¹⁾	X	X	X	X	–	–
Curtains ³⁾	X	X	–	X	–	–
Starch	–	–	–	X	–	–

¹⁾ Use liquid detergent.

²⁾ Only use proofing agents which are stated by the manufacturer as being suitable for use on membrane textiles. Do not use proofing agents which contain paraffin. Add proofing agents to the fabric conditioner compartment ☼.



³⁾ Use powder detergent

Specialist detergent: This detergent is designed specifically for the wash programme or type of fabric, (see the Miele CareCollection detergents and conditioning products in "Optional accessories").

WASHING

All modern detergents produced for automatic washing machines are suitable. Use dispensing aids, e.g. balls, if these are supplied with the detergent. Tablets are suitable for full loads, but note that it may be impractical to reduce tablets for smaller loads. Some tablets do not dissolve as rapidly as others, and may not be suitable for programmes with short durations. Do not use biological detergents on silk, as the enzymes may damage the silk. Instructions for use and recommended dosage amounts are given on the detergent packaging.

Liquid detergent should be dispensed using a ball provided by the manufacturer for programmes without a pre-wash.

For programmes with a pre-wash you will need to purchase a special container from the Miele Spare Parts department which sits in the main wash compartment  of the detergent dispenser drawer. Add liquid detergent to this container for the main wash and to compartment  for the pre-wash.

See "Optional accessories" at the end of this booklet for details of Miele branded care products, including detergents and fabric conditioner.

The right amount to dispense will depend on the following:

- The soiling level of the laundry

Lightly soiled

No visible dirt or stains. Possibly slight body odour.

Normally soiled

Visibly dirty and/or just a few slight stains.

Heavily soiled

Visible dirt and stains and/or dried on soiling.

- The quantity of the laundry (add the recommended amount of detergent).
- The water hardness level. Check with your local water supplier if you do not know the hardness level in your area.

Water softeners

A water softener can be used to cut down on the use of detergents in hard water areas. Dispense according to the amount specified on the packaging. First add detergent and then the water softener.

Use the same quantity of detergent as for soft water.

Washing with several components

If you wash using several components (e.g. special application detergents), we recommend always dispensing the agents into compartment  in the following order:

1. Detergent
2. Water softeners
3. Stain remover

This way the agents are distributed more evenly.

Fabric conditioner and liquid starch

Fabric conditioners make garments soft to handle and help prevent static cling when tumble drying.

Starch stiffens and gives body to items of laundry, e.g. shirts, tablecloths and bed linen.

Automatic dispensing of fabric conditioner or liquid starch to laundry at the end of a programme

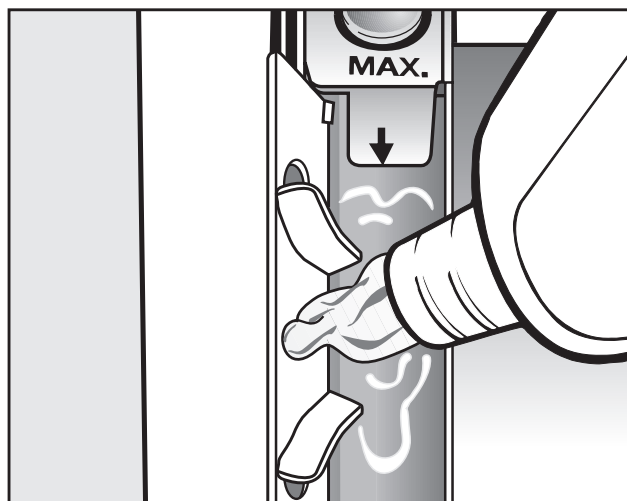

- Add the fabric conditioner or liquid starch to compartment ☼. **Do not exceed the maximum level mark.**

It will be dispensed automatically in the last rinse. At the end of the programme a small amount of water remains in the fabric conditioner compartment ☼.

If starching frequently, thoroughly clean the dispenser compartment, especially the siphon tube and fabric conditioner channel, regularly. See "Cleaning the detergent dispenser drawer".

Do not use powder starch formulations or viscous liquid starch in the ☼ compartment as it will clog up. See below.

Adding fabric conditioner or liquid starch separately

- Dispense in accordance with manufacturer's instructions on the packaging.
- Dispense liquids into the ☼ compartment and powder or viscous formulations into the ▮ compartment.
- Turn the programme selector to *Further programmes/Settings* and select the *Starch* programme.
- Select a spin speed or the *Rinse hold* extra option.
- Press the *Start/Stop* button.

Colour run and dye removers/dyes

- Do not use colour run or dye removers in this machine.
- Dyes suitable for use in domestic washing machines can be used. However, please note that the salt used in the dyeing process can cause corrosion to stainless steel components in the machine if you dye frequently. Follow the manufacturer's instructions carefully.

DRYING

Separate drying

The separate drying programme must be used if the load in the wash programme is greater than the maximum load permitted for drying, or if you only want to dry part of the load that was washed.

Tips on drying

Do not put soaking wet items into the machine to dry them; Spin them thoroughly after washing using the appropriate spin speed.

- Woollens and wool blends tend to become matted and shrink if dried in a tumble dryer. They can be partially dried using the *Woollens* programme.
- Down-filled garments have linings which have a tendency to shrink, depending on the quality of the item. They can be partially dried using the *Smoothing* programme.
- Pure linen should only be machine dried if specified as suitable by the manufacturer on the care label, as the surface of the fabric may otherwise tend to roughen.
- Loopknit garments (e.g. T-shirts and underwear) tend to shrink depending on their quality. Therefore: Do not over-dry these textiles. When purchasing these garments it is advisable to take their shrinkage properties into account.
- Starched laundry can be dried in the tumble dryer. To achieve the usual finish, double the amount of starch should be used.
- New dark coloured garments should be washed and dried separately from light coloured garments to avoid the danger of colours running and discolouring other garments. Dark coloured fibres can also settle on light coloured garments and vice versa.

1 Sort the laundry

- Sort the laundry according to type of fibre / weave and the residual moisture content. This will help achieve an even drying result.
- Before drying check the drying symbol on the care label.
- Dry at normal temperature
- Dry at a low temperature (select the *Low temperature* extra option)
- Do not tumble dry

If the care label does not have a drying symbol on it, the item should only be dried in a programme named as suitable for it.

2 Switch the washer-dryer on

3 Select a programme

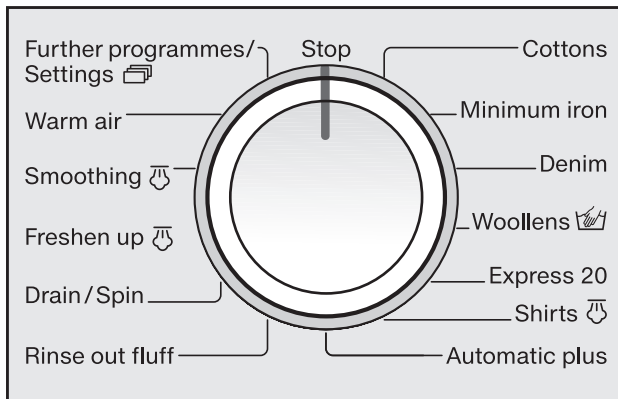

- Select the drying programme you want.

The programme selected will appear in the display.



Further programmes:

Turn the programme selector to *Further programmes/Settings* to display a list of other programmes that the machine has to offer.



- Use the ∇ or \blacktriangle button to highlight the programme you wish to select and confirm your selection by pressing the **OK** button.
- Press the *Washing/Drying* button repeatedly until **only** the *Drying* indicator light is lit up.

The *Washing* indicator light must not be lit as well as this would mean that the relevant washing programme would begin before the drying process.



- Use the ∇ or \blacktriangle button to alter the drying level. Press the **OK** button to confirm the drying level selected and move on to the thermospin speed option.



- Use the ∇ or \blacktriangle button to alter the spin speed.

The thermospin is not carried out if a drying time is selected.

- Select the *Low temperature extra* option if required.

The thermospin is not carried out when the *Low temperature extra* option has been selected.

- Select the *Extra quiet extra* option by pressing the *Further extras* button, if required.
- Select *Delay start*, if required.

DRYING

4 Load the drum

- Open the drum door.
- Load the laundry loosely into the drum.

See the drying programme chart for maximum loads. Overloading can cause unnecessary wear and tear to the laundry and give a disappointing drying result.

5 Close the drum door.

Make sure that no garments are caught between the drum door and seal.

Make sure you have removed any detergent dispensing aids, e.g. plastic dispenser balls, before drying. These dispensers can melt during the drying programme and cause damage to the machine and the laundry.

The stopcock must be open even if you are only using the machine for drying.

6 Start the programme

- Press the flashing *Start/Stop* button.

The estimated programme duration will appear in the display. The electronics continually assess the residual moisture content of the laundry and adjust the estimated time remaining for a more accurate reading. Because of this the time displayed can alter during the course of a programme. The time left

will count down by the minute in the display.

The programme sequence and the drying level reached will also be shown in the display.

7 End of the programme - unload the drum

The anti-crease phase starts as soon as the programme finishes.

The washer-dryer will switch off automatically 15 minutes after the end of the anti-crease phase. You will need to press the ① button to switch it back on again.

- Turn the programme selector to the *Stop* position.
- Open the drum door and remove the laundry.

Check that all items have been removed from the drum. Anything left in the machine could be damaged by overdrying when it is next used.

Important. Always remove the laundry before switching the machine off. This is important to ensure that the load size indicator works correctly.

- Switch the machine off.

See "After each washing or drying programme" in "WASHING AND DRYING" for further information.

Extra options

Low temperature

The temperature is reduced during the drying programme.

For all delicate or minimum iron fabrics with the  symbol on the care label (e.g. acrylic garments).

The thermospin is not carried out when the *Low temperature* extra option has been selected.

Because the temperature is reduced when the *Low temperature* extra option has been selected, the programme duration is longer.

The *Low temperature* extra option is *only* available for a drying programme.

Thermospin

To save energy a thermospin is carried out in some programmes.

The thermospin is not carried out if a drying time is selected.

The thermospin is not carried out when the *Low temperature* extra option has been selected.

The maximum spin speed for the thermospin is the same as the maximum final spin speed for the relevant wash programme.

Extra quiet

If you want to use your machine to dry laundry during quiet periods, you can reduce the noise level.

- The buzzer will not sound.
- The thermospin speed is limited to a maximum of 900 rpm.

- Press the *Further extras* button.



- Confirm selection of *Extra quiet* with the **OK** button.

Press the *Further extras* button again to come out of the *Extras* menu.

DRYING

Adding or removing laundry after a programme has started

- Press the *Door* button to open the drum door.

 Do not touch the metal cap located on the inside of the door glass or the back of the drum when adding or removing items. They could be very hot - **Danger of burning.**

- Add or remove items as required.
- Close the drum door.

The programme will continue automatically.

The time left shown in the display may now vary from the actual drying time.

The door cannot be opened, if:

- the temperature in the drum is **above 70°C**.
- the programme has reached the *Final spin* stage.
- the safety lock has been activated.

Programme chart

Cottons		Max. load 3.0 kg*
Extra dry, Normal+, Normal**		
Suitable for	Single and multi-layered cotton fabrics such as T-shirts, underwear, towelling, flannelette bed linen.	
Note	Do not use <i>Extra dry</i> for loopknit fabrics as they have a tendency to shrink.	
Extras	Low temperature, thermospin, Extra quiet	
Hand iron Δ, Hand iron $\Delta\Delta$** , Machine iron, Smoothing+¹⁾, Timed drying²⁾		
Suitable for	Cotton or linen fabrics e.g. table linen, bed linen, starched laundry etc.	
Note	To prevent laundry from drying out, it should be rolled up until you are ready for ironing.	
Extras	Low temperature, thermospin, Extra quiet	
Minimum iron		Max. load 1.5 kg*
Normal+, Normal**, Hand ironΔ, Smoothing+¹⁾, Timed drying²⁾		
Suitable for	Minimum iron items made of synthetic or blended fabrics, e.g. tops, blouses, skirts and table cloths.	
Extras	Low temperature, thermospin, Extra quiet	
Denim		Max. load 3.0 kg*
Extra dry, Normal+, Normal, Hand ironΔ, Hand iron$\Delta\Delta$, Machine iron, Smoothing+¹⁾, Timed drying²⁾		
Suitable for	Denim garments, e.g. jeans, jackets, skirts, shirts.	
Extras	Thermospin, Extra quiet	
Woollens		Max. load 1.0 kg*
3 minutes		
Suitable for	Wool and wool blend fabrics.	
Note	<ul style="list-style-type: none"> – This programme only fluffs up woollen garments. They are not dried completely by this programme. – Remove garments as soon as the programme has finished and leave to finish drying at room temperature. 	

* Weight of dry laundry

** Note for test institutes: Programme setting for testing according to EN 61121 standard

DRYING

Express 20		Max. load 3.0 kg*
Extra dry, Normal+, Normal, Hand ironΔ, Hand iron$\Delta\Delta$, Machine iron, Smoothing+¹⁾, Timed drying²⁾		
Suitable for	Fabrics which can tolerate high temperatures and which can be dried using the <i>Cottons</i> programme.	
Note	If washing and drying in one operation the programme duration will be particularly short with the <i>Express 20</i> programme.	
Extras	Thermospin, Extra quiet	
Shirts		Max. load 1.0 kg*
Normal+, Normal, Hand ironΔ, Smoothing+¹⁾, Timed drying²⁾		
Suitable for	Shirts and blouses	
Note	Garments are dampened before the programme starts to help reduce creasing.	
Automatic plus		Max. load 3.0 kg*
Normal+, Normal, Hand ironΔ, Smoothing+¹⁾, Timed drying²⁾		
Suitable for	Mixed loads of garments suitable for the <i>Cottons</i> and <i>Minimum iron</i> programmes.	
Extras	Thermospin, Extra quiet	
Freshen up		Max. load 1.0 kg*
Suitable for	Freshly laundered and spun garments, or dry garments that have been worn briefly and are not soiled.	
Note	<ul style="list-style-type: none"> – Garments are dampened before the programme starts to help reduce creasing. – Select the <i>Water plus</i> extra for very absorbent fabrics. 	
Select:	<ul style="list-style-type: none"> – Normal: For garments that are required immediately. – Hand iron $\Delta\Delta$: For garments that are to be ironed or hung out to completely dry on a coat hanger. – Timed drying²⁾: Check the items as you are drying them to find the optimum time. 	
Important	<ul style="list-style-type: none"> – Creasing increases the larger the load and the longer the drying time. 	

* Weight of dry laundry

DRYING

Smoothing		Max. load 3.0 kg*
Suitable for	Cotton and linen fabrics. Minimum iron items made of mixed fibres, cotton or synthetic fabrics	
Note	<ul style="list-style-type: none"> – Garments are dampened before the programme starts to help reduce creasing. – They are not completely dried in this programme to make them easier to iron. – Remove garments as soon as the programme finishes. – Select the <i>Water plus</i> extra for very absorbent fabrics. 	
Warm air		Max. load 3.0 kg*
Timed drying²⁾		
Suitable for	For drying or airing individual items.	
Note	Do not select the longest drying time to start with. Check the items as you are drying them to find the optimum time.	

Further programmes

Dark garments		Max. load 3.0 kg*
Normal+, Normal, Hand iron Δ, Smoothing⁺¹⁾, Timed drying²⁾		
Suitable for	Dark garments made from cotton or mixed fibres.	
Extras	Low temperature, thermospin, Extra quiet	
Delicates		Max. load 1.0 kg*
Normal, Hand iron Δ, Timed drying²⁾		
Suitable for	For delicate fabrics made of synthetic fibres, mixed fibres, easy care cotton shirts and blouses.	
Extras	Extra quiet	

* Weight of dry laundry

DRYING

Sportswear		Max. load 2.0 kg*
Normal+, Normal, Hand ironΔ, Smoothing+¹⁾, Timed drying²⁾		
Suitable for	Sportswear that is suitable for tumble drying	
Extras	Thermospin, Extra quiet	
Trainers		Max. 2 pairs of shoes
Timed drying²⁾		
Suitable for	Trainers, specified as machine-washable by the manufacturer.	
Note	<ul style="list-style-type: none"> – The drum does not rotate during this programme. – Insoles should be removed and placed in the drum with the shoes. 	
Outerwear		Max. load 1.5 kg*
Normal+, Normal, Hand ironΔ, Smoothing+¹⁾, Timed drying²⁾		
Suitable for	Outerwear which is suitable for drying in a tumble dryer.	
Extras	Thermospin, Extra quiet	
Proofing		Max. load 1.5 kg*
Normal		
Suitable for	Thermally fixing textiles which are suitable for drying in a tumble dryer and have been treated with a proofing agent.	
Extras	Extra quiet	
Soft toys		Max. load 1.0 kg*
Timed drying²⁾		
Suitable for	Soft toys that can tolerate being dried in a tumble dryer.	
Note	Observe the manufacturer's care label.	
Extras	Extra quiet	

* Weight of dry laundry

DRYING

Hygiene		Max. load 3.0 kg*
Normal		
Suitable for	Cottons and linen fabrics which are in direct contact with the skin, e.g. underwear, nappies, towelling, bed linen, pillow and mattress covers.	
Important	Because the temperature is held for longer the laundry will feel drier.	
Extras	Thermospin	
First wash		Max. load 3.0 kg*
Normal+, Normal, Hand ironΔ, Smoothing+¹⁾, Timed drying²⁾		
Suitable for	New items made of cotton, towelling and polyester fabrics.	
Extras	Thermospin	
Silks		Max. load 1.0 kg*
5 minutes		
Suitable for	Silks (suitable for drying in a tumble dryer), e.g. blouses and shirts.	
Note	<ul style="list-style-type: none"> – Smooths out creasing. – Garments are not totally dried in this programme. – Remove garments immediately at the end of the programme. 	
Pillows		2 pillows (40x80 cm) or 1 pillow (80x80 cm)
Timed drying²⁾		
Suitable for	Pillows suitable for drying in a tumble dryer, with feather, down or synthetic fillings.	
Note	Please observe the instructions on the care label. Pillows can still feel damp after being dried. You can use this programme several times until the pillow feels dry.	
Cool air		Max. load 3.0 kg*
Timed drying²⁾		
Suitable for	Any item which only needs airing.	

DRYING

- 1) **Smoothing+**: Garments are dampened before the programme starts to help reduce creasing. Textiles are not completely dried in this programme to make them easier to iron. The drying temperature is determined by the programme being used.
- 2) **Timed drying**: Timed drying is particularly suitable for small loads and for drying individual items. Garments are dried in warm air (times of between 15 minutes and 2 hours can be selected). The drying temperature is determined by the programme being used. Do not select the longest drying time to start with. Check the items as you are drying them to find the optimum time.

Washing and drying in a continuous sequence

Where the amount of laundry to be washed and dried in one programme does not exceed the maximum weight permitted for the drying programme, washing and drying in one continuous sequence is recommended.

It is very important to read both the "Washing" and "Drying" sections before proceeding.

1 Sort the laundry into colours and fabric types

2 Switch the machine on

3 Select a programme

- Turn the programme selector to the required programme.
- Press the *Washing/Drying* button repeatedly until both the *Washing and Drying* indicator lights are lit up.

Cottons	
60°C	1600 rpm
Normal	2:52 h

- Select the temperature, spin speed and drying level and confirm with **OK**.

To avoid the laundry forming a ring against the drum at the end of the washing programme, the spin speed is limited to a maximum of 1200 rpm when washing and drying in a continuous sequence.

- Select the drying level or drying time you require.
- Now select extra options, if required.

The spin speed displayed for washing will be adopted for the thermospin. If you select *Extra quiet*, spinning will not exceed 900 rpm.

The thermospin is not carried out when the *Low temperature* extra option has been selected.

- Select Delay start, if required.

WASHING AND DRYING

④ Load the drum

- Open the drum door and load the laundry loosely in the drum.

Follow the load size indicator and do not overload.

Do not use detergent dispensing aids, e.g. plastic dispenser balls, for washing followed immediately by the drying programme. These dispensers can melt during the drying programme and cause damage to the machine and the laundry.

⑤ Close the drum door

⑥ Add detergent

Follow the detergent percentage display.

⑦ Start the programme

- Press the *Start/Stop* button.

⑧ Remove the laundry when the programme has finished

- Turn the programme selector to the *Stop* position.
- Open the drum door and remove the laundry.

See "After each washing or drying programme" for further information.

After each washing or drying programme

- Open the drum door **fully**.

 **Caution, the metal cap located on the inside of the door glass is very hot after drying.** Do not touch it. It will be hot. Danger of burning!

- Remove the laundry.
- Check the folds in the door seal for any small articles, e.g. buttons, which might be lodged there. Remove any fluff remaining from around the door seal and porthole glass after drying.

Check that all items have been removed from the drum. Items left behind could colour run, shrink or be damaged in the next washing or drying programme.

Important: Always remove the laundry before switching the machine off. This is important to ensure that the load size indicator works correctly.

- Switch the machine off using the On/Off button ①.

Close the door.

Otherwise there is the danger of objects being placed inadvertently in the drum. If these remained unnoticed and were washed in the next load, they could damage the laundry.

Rinse out fluff programme

The fluff which occurs during drying can collect in the drum and also in the suds container. Run the *Rinse out fluff* programme before the machine is used again so that fluff cannot be deposited on the next load (e.g. fluff from dark garments being deposited on lighter coloured items) or cause a blockage.

The *Rinse out fluff* programme must not be used for rinsing laundry. Make sure that there are no items of laundry in the drum before starting this programme.

- Switch the machine on.
- Turn the programme selector to the *Rinse out fluff* programme.

If there is a lot of fluff in the machine select the *Water plus* extra option.

- Press the *Start/Stop* button.

The fluff will be rinsed out after a few minutes.

- Remove any fluff remaining from around the door seal and porthole glass.
- Switch the machine off.

The load sensor will have to be recalibrated after running the *Rinse out fluff* programme. See "Before using for the first time".

Changing the programme sequence

To cancel a programme

You can cancel a programme at any time after it has started.

- Press the *Start/Stop* button and select *Cancel programme* or turn the programme selector to *Stop*.

... During washing:

The suds will be pumped away and the washing programme is cancelled.

... During drying:

The garments will be cooled down before the door can be opened.

If you want to remove the laundry:

- Press the *Door* button.

If you want to select a different programme:

- Switch the machine off using the ⏻ button.
- Check that there is still detergent in the detergent drawer. Add detergent if necessary.
- Switch the machine back on again and select a new programme.

Interrupting a programme

- Switch the machine off using the ⏻ button.

To continue with the same programme:

- Switch the machine back on again with the ⏻ button.

 Do not switch the washer-dryer off before the end of a drying programme. If this was done and the laundry was then removed immediately it could give off a great amount of heat.

Changing a programme

After the start of a programme it is no longer possible to select a different programme.

You will need to cancel the current programme before you can select a new one.

Altering the temperature

You can alter the temperature of a washing programme up to 5 minutes after the programme has started.

- Use the ∨ and ∧ buttons to alter the temperature.

Changing the programme sequence

Changing the spin speed

You can change the spin speed up until the final spin begins.

You can change the thermospin speed up until the thermospin begins.

Altering the drying level / drying time

You can alter the drying level or drying time during the washing programme but not once the drying programme has started.

Selecting or deselecting a drying programme

You can select or deselect the drying function during a washing programme if this is permitted for the particular programme.

Changing extra options

It is possible to select or deselect some extra options up to 5 minutes after the washing programme has started.

It is not possible to make any changes if the safety lock has been activated.

Safety lock

The safety lock prevents the machine from being opened or the programme cancelled during a washing or drying programme.

To activate the safety lock

- Press the *Start/Stop* button.
- Select *Activate safety lock* and confirm your selection.

The machine will now not accept any changes and the programme will proceed through to the end.

The safety lock is deactivated automatically at the end of the programme.

To deactivate the safety lock

- Press the *Start/Stop* button.
- Select *De-activate safety lock* and confirm your selection.

Delay start

With delay start you can choose when you want the programme to end. The start of a programme can be delayed from 30 minutes up to a maximum of 24 hours,

The current time of day needs to have been set for Delay start to work correctly.

Select Delay start

- Select the programme you want and then press the ⊕ button.

Delay start	9:51
Start time	9:51
Finish time	11:19

The display shows the current time of day and the time the programme is due to end.

- Use the ^ button to select the time you want the programme to end at.

Delay start	9:51
Start time	9:51
Finish time	15:00

The first press on the button will adjust the programme end time to the next 15, 30, 45 minutes or full hour. Each subsequent press on the button will delay the programme end time by 15 minutes.

- Confirm your selection by pressing the **OK** button.

To begin Delay start

- Press the *Start/Stop* button.

Altering Delay start

- Press the ⊕ button.
- Use the ∨ or ∧ buttons to change the programme end time.
- Confirm your selection by pressing the **OK** button.

Cancelling delay start

- Press the *Start/Stop* button.
- *Cancel delay start* will appear in the display.
- Confirm with **OK**.
- Press the *Start/Stop* button to start the programme straight away or select a different programme.

The actual load size can only be determined accurately by the machine once the programme has started. The programme end time may, therefore, be a bit later or earlier than first indicated.

⚠ Disconnect the machine from the electricity supply by switching off at the wall socket and withdrawing the plug before any cleaning and maintenance work.

A range of Miele branded cleaning and conditioning agents is available to order from the Miele Spare Parts Department, or via the internet on www.miele-shop.com.

Cleaning the machine

⚠ Do not use solvents, abrasive cleaners, glass cleaners or all-purpose cleaning agents. These might damage plastic surfaces and other components because of the chemicals they contain.

⚠ The machine must not be hosed down.

- Clean the casing and the control panel with a mild non-abrasive cleaning agent or soap and water. Wipe dry with a soft cloth.
- The drum can be cleaned using a suitable stainless-steel cleaning agent following the instructions on the packaging.

Extra cleaning

Carry out a hot wash (70°C or above) with powder detergent approx. every 6 weeks to help prevent deposits building up in the machine. These can occur when washing is mainly done at low

temperatures, and can lead to unpleasant odours. If you have no reason to wash occasionally at this high temperature, then run a Cottons 95°C programme with detergent but no laundry at regular intervals.

Cleaning the detergent dispenser drawer

The pre-wash and main wash compartments of the detergent drawer are self-cleaning. However, for hygiene reasons the entire detergent drawer should be cleaned as follows on a regular basis.

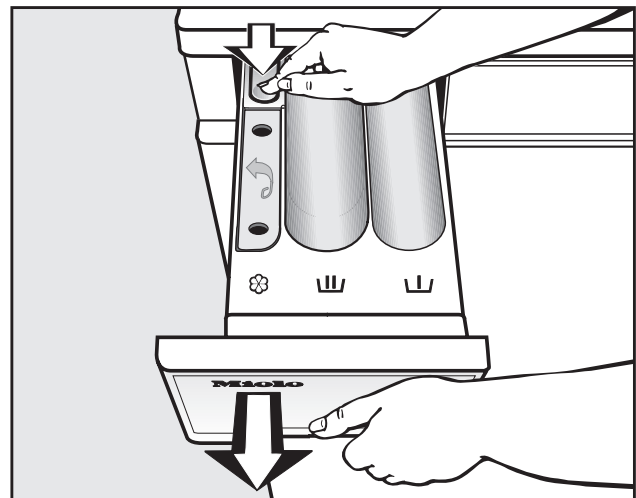

- Pull out the detergent dispenser drawer until a resistance is felt. Press down the release catch and at the same time pull the drawer right out of the machine.
- Clean the detergent drawer with hot water.

Cleaning and care

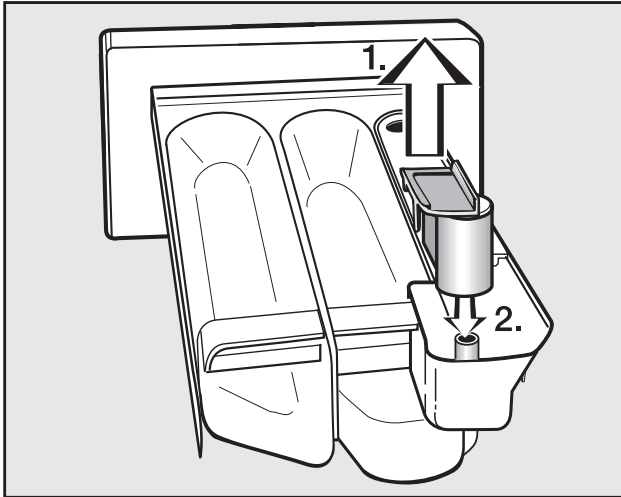

■ Clean the siphon.

1. Remove the siphon from compartment  and rinse under hot running water. Clean the siphon tube in the same way.
2. Replace the siphon.

If starching frequently, thoroughly clean the siphon and siphon tube regularly. A build-up of starch will cause them to get clogged.

Cleaning the detergent dispenser drawer housing

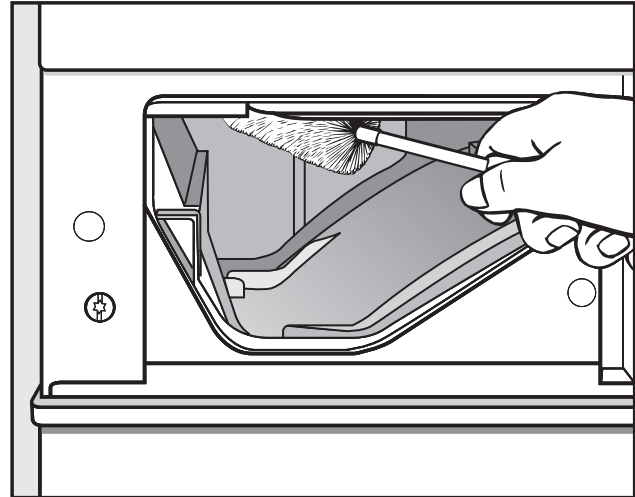

- Use a bottle brush to remove detergent residues and limescale from the jets inside the detergent dispenser drawer housing.

Cleaning the porthole glass

- From time to time you should also clean ...
 - the door glass on the inside using a mild detergent or soap and water.
 - the metal cap on the inside of the door glass with a suitable proprietary stainless steel cleaning agent following the manufacturer's instructions on the packaging.
- Wipe dry using a soft cloth.

Cleaning the filter in the water inlet

The machine has a filter to protect the water inlet valve.

The accessible filter in the union in the open end of the inlet hose should be checked every six months, or more often if there are frequent interruptions to the external water supply.

- First turn off the stopcock and then unscrew the threaded union connecting the free end of the inlet hose to the stopcock.

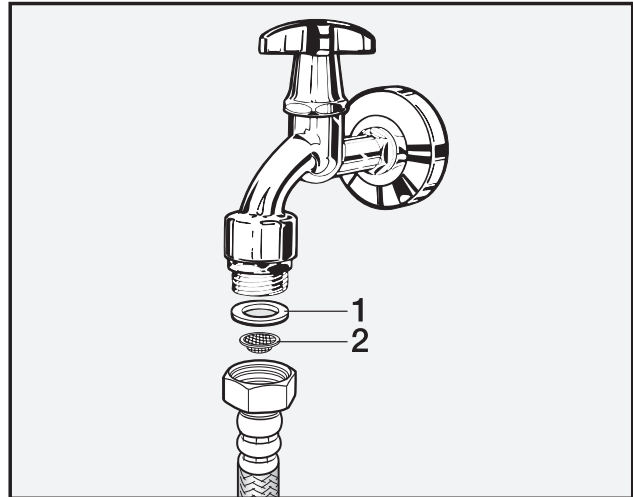

- Remove the rubber seal **1** from the recess.
- Hold the free end of the inlet hose upside down. The plastic filter **2** will fall out.
- Clean the plastic filter.
- Put the filter and seal back in the reverse order and reconnect the hose.

Turn on the stopcock and check the connection is watertight. If it leaks, tighten the connection.

Never forget to put the filter back in place after cleaning.





Problem solving guide

With the help of the following notes, minor faults in the performance of this machine, some of which may result from incorrect operation, can be put right without contacting the Service Department.

 Repair work to electrical appliances should only be carried out by a suitably qualified person in strict accordance with current local and national safety regulations. Repairs and other work by unqualified persons could be dangerous. The manufacturer cannot be held liable for unauthorised work.

The programme does not start

Problem	Possible cause	Remedy
The display remains dark and the programme selector is not lit up.	There is no power to the machine.	Check whether <ul style="list-style-type: none">– the mains plug is plugged in and switched on.– the fuse or circuit breaker has tripped.
You are asked to enter a code.	Access via a code has been activated. See the <i>Settings</i> menu.	Enter the code and confirm the entry. Deactivate the code if you do not wish this message to appear in the display the next time the machine is switched on.
The programme does not start when <i>Drain/Spin</i> has been selected.	The machine has not been prepared for using for the first time.	Prepare the machine as described in "Before using for the first time".
The display is dark.	The display has switched off automatically to save energy (Standby mode).	Press a button. The machine comes out of standby mode.

A fault message appears in the display		
Message	Possible cause	Remedy ①
 <p>Fault Check drainage system</p>	<ul style="list-style-type: none"> – The water outlet is blocked or restricted. – The drain hose has been fixed too high. 	<ul style="list-style-type: none"> – Clean the drain filter and the drain pump as described in "Problem solving guide – Opening the drum door in the event of a blocked drain outlet and/or power failure". – The maximum delivery head is 1 m.
 <p>Fault Water intake Open stopcock</p>	<p>The water inlet is blocked or restricted.</p>	<p>Check whether</p> <ul style="list-style-type: none"> – the stopcock is opened wide enough. – the inlet hose is kinked. – If the fault message appears again, contact the Miele Service Dept.
 <p>Waterproof system activated Close the stopcock</p>	<p>The water protection system has reacted.</p>	<ul style="list-style-type: none"> – Close the stopcock. – Contact the Miele Service Department.
 <p>Technical fault Call Service.</p>	<p>There is a fault.</p>	<p>Start the programme again. If the fault message appears again, contact the Miele Service Department.</p>
<p>Check detergent</p>	<p>Excessive foam has built up during washing.</p>	<p>Use less detergent next time and follow the manufacturer's instructions on dosage given on the packaging.</p>

① To delete the message from the display switch the machine off using the On/Off button ①.

Problem solving guide

Problems with the load size indicator		
Problem	Possible cause	Remedy
The display indicates a load of <25% or no load size is indicated when the drum is full.	Laundry was left in the drum when the machine was switched off. This has decalibrated the sensor from the zero setting.	To recalibrate the sensor to the zero setting: <ul style="list-style-type: none"> – Remove the laundry from the drum. – Switch off the machine and leave the door open. – Switch on the machine. – Turn the programme selector to <i>Cottons</i>. – Press and hold the <i>Load % / Detergent %</i> button in until the following message appears in the display: <i>Zero setting OK</i>
	The load sensor has to be recalibrated to zero after running the <i>Rinse out fluff</i> programme.	
The display indicates a load of 25%, 50%, 75% or 100% when the drum is empty.	The load size sensor has been decalibrated from the zero setting.	Rotate the drum once. If the display still indicates a load of 25%, 50%, 75% or 100%, recalibrate the sensor to zero again (see above section).
The following will appear in the display: Zero setting not possible. Open the door	The drum door is closed.	<ul style="list-style-type: none"> – Open the drum door. – Recalibrate the sensor to zero again.
The drying programme stops and the following message appears in the display: Check load	There is very little or no laundry in the drum. Drying individual garments or items which are already dry can also cause the programme to be cancelled.	In future use a timed drying programme or the <i>Warm air</i> timed drying programme for individual items.
At the end of a drying programme the following message appears in the display: Check load	The machine has recognised an overload.	In future do not exceed the maximum load.

Problem solving guide

General problems		
Problem	Possible cause	Remedy
The machine shakes during the spin cycle.	The machine feet are not level.	Level the machine (see "Installation and connection").
The pump makes strange noises.	This is not a fault. These noises occur at the end of a pump sequence as a normal part of operation.	
Large amounts of detergent residue remain in the detergent dispenser drawer.	The water pressure is too low.	<ul style="list-style-type: none"> – Clean the filter in the water inlet. – It may be useful to select the <i>Water plus extra</i> option.
	Powder detergent used in conjunction with water softeners tends to become sticky.	Clean the detergent drawer. In future, add washing powder to the dispenser drawer first, and then add the water softener.
Fabric conditioner is not completely dispensed or too much water remains in the ☼ compartment.	The siphon tube is not correctly positioned or is clogged up.	Clean the siphon (see "Cleaning and care - Cleaning the detergent dispenser drawer").
The display is in a different language.	A different language has been selected in the <i>Settings</i> menu - "Language 🚩".	Set the language you want. The flag symbol will guide you.
Foam comes out of the detergent dispenser drawer while the <i>Rinse out fluff</i> programme is running.	Detergent residue from the previous washing programme was still present in the suds container.	It is important to dispense the correct amount of detergent. Use the <i>Load/Detergent</i> button.
The duration fluctuates in the display.	The machine continually monitors the washing and drying process and adjusts the duration accordingly.	

Problem solving guide

An unsatisfactory wash result		
Problem	Possible cause	Remedy
Liquid detergent does not give the required result.	Liquid detergents usually contain no bleaching agents. They do not remove fruit, coffee and tea stains.	<ul style="list-style-type: none"> – Use a general purpose detergent containing a bleaching agent. – Pour stain removers into compartment III and liquid detergent into a dispenser ball (remember to remove the dispensing ball before drying!). – Never put stain removers and liquid detergent together in the dispenser drawer.
Grey, greasy particles cling to washed laundry.	Insufficient amounts of detergent were used to break down the particles of grease in heavily soiled laundry.	<ul style="list-style-type: none"> – Use more detergent. – Before washing the next load run a Cottons 95°C programme with powder detergent but without a load.
White residues which look like powder detergent are seen on dark textiles after washing.	The detergent contained compounds (zeolites) to aid water softening which are not soluble in water. They have ended up on the laundry.	<ul style="list-style-type: none"> – Try and brush off the residues with a soft brush once the laundry is dry. – Wash dark textiles using a detergent which contains no zeolites. Liquid detergents usually contain no zeolites. – Use the <i>Dark garments</i> programme for dark coloured laundry.

An unsatisfactory drying result		
Problem	Possible cause	Remedy
The laundry is still damp after a drying cycle.	The load was too small for the electronics to assess the residual moisture correctly.	In future dry small loads in a timed drying programme.
	The laundry has formed a ring in the drum during the spin because it was distributed unevenly.	– Turn the programme selector to <i>Stop</i> . – Open the door and loosen the laundry.
	The laundry has formed a ring in the drum during the thermospin because it was too damp or the spin speed was set too high.	– Start the drying programme again using a lower spin speed.
	Warm laundry feels damp.	Extend the cool down time, as described in the <i>Settings</i> menu.
The laundry is too damp or too dry after a drying cycle.	The required residual moisture level is between two drying levels.	Change the drying levels as described in the <i>Settings</i> menu.
When laundry is dry it feels hard to the touch.	Too vigorous wash action.	Programme in gentle action and more water.
	Not enough detergent was used.	Increase detergent dose to prevent limescale build up in laundry.
	No fabric conditioner was used.	Use fabric conditioner in last rinse.
There is still water in the drum after drying.	There is a blockage in the water outlet.	Clean the drain filter and the drain pump as described in "Problem solving guide – Opening the drum door in the event of a blocked drain outlet and/or power failure".

Problem solving guide

The drum door cannot be opened by pressing the <i>Door</i> button	
Problem	Remedy
The machine is not connected to the electricity supply and / or is not switched on.	Insert the plug in the socket and switch on and / or switch the machine on with the Ⓜ button.
The safety lock has been activated.	Deactivate the safety lock as described in "Changing the programme sequence - Safety lock".
Access via a code has been activated.	Deactivate the code as described in the <i>Settings</i> menu.
Power cut.	Open the drum door as described in the next section.
The door was not correctly engaged.	Press hard against the lock side of the drum door and then press the <i>Door</i> button.
There is still water in the drum and the machine is unable to drain.	Clean the drain filter and drain pump as described in the next section.
The door cannot be opened during or after drying.	For safety reasons the drum door cannot be opened if the temperature is higher than 70°C. <ul style="list-style-type: none"> – Wait until the temperature is less than 70°C. – Deactivate the <i>Extended cool down</i> time as described in the <i>Settings</i> menu.
For safety reasons the drum door cannot be opened if the suds temperature is higher than 55°C.	

Opening the drum door in the event of a blocked drain outlet and/or power failure

- Switch the machine off.

There is a lever behind the detergent drawer fascia panel.

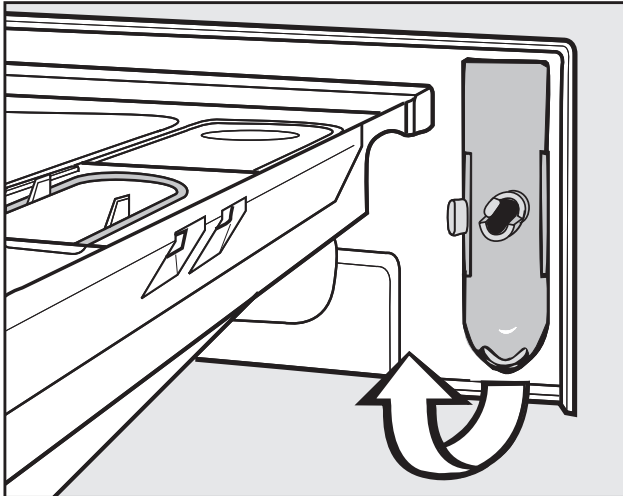

- Remove the lever.

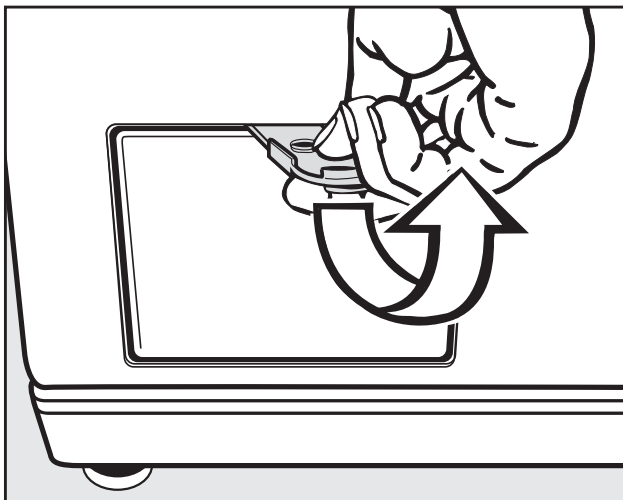

- Use it to open the access flap.

Blocked drain outlet

If the drain outlet is blocked, up to 25 litres of water will be retained in the machine.

⚠ Caution: if laundry has been washed at a high temperature, water draining out of the machine will still be hot. Danger of scalding!

Procedure for draining the machine

- Place a suitable container under the access flap.

When draining water from the machine, do **not** unscrew the drain filter completely or take it right out.



- Unscrew the drain filter lid until water runs out.

To interrupt the flow of water:

- Tighten the drain filter back up again.

Problem solving guide

Once the flow of water ceases:

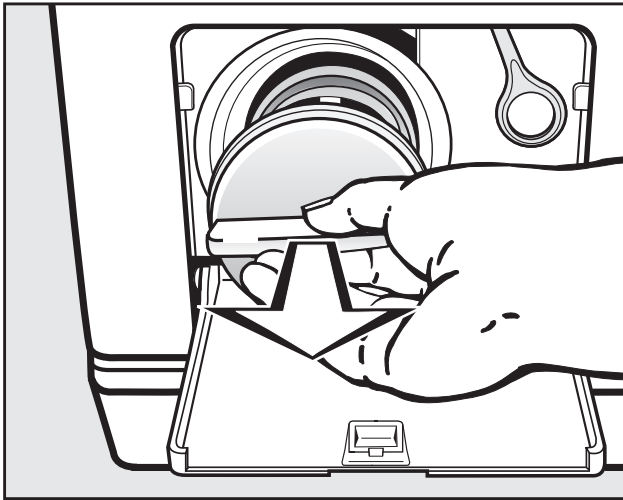

- Remove the drain filter completely.
- Clean it thoroughly.

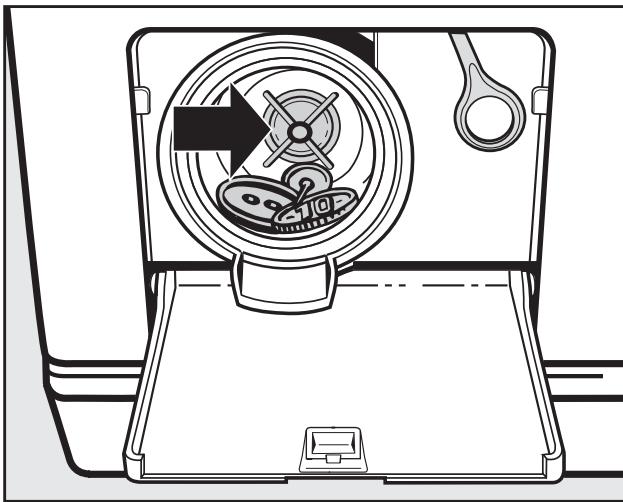

- Remove any foreign objects (e.g. buttons, coins, etc.) and fluff from the filter housing. Turn the impeller by hand to check that it rotates freely.
- Put the drain filter back in place and secure.

⚠ Make sure the drain filter is securely tightened. Otherwise there is a risk of water leakage during use.

To avoid loss of detergent, pour approx. 2 litres of water into the detergent dispenser drawer after cleaning the drain filter. Excess water will be pumped out automatically before the next wash programme.

Opening the drum door

⚠ Always make sure that the drum is stationary before reaching into the machine to remove laundry. Reaching into a moving drum is extremely dangerous.

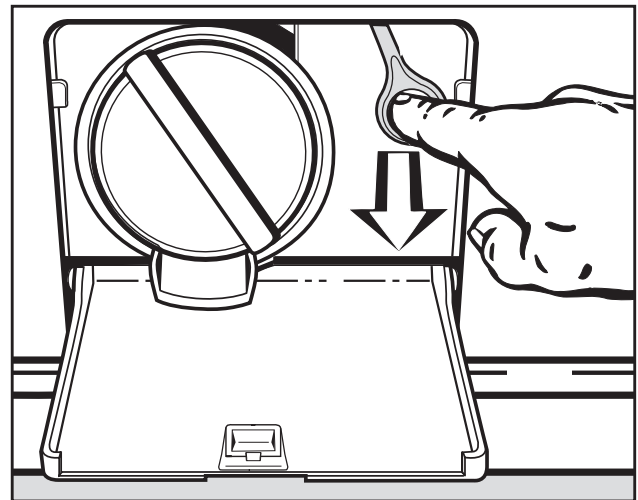

- Pull the emergency release downwards (see illustration). The drum door will open.

In the event of any faults which you cannot remedy yourself, please contact:

- your Miele dealer, or
- the Miele Service Department (see back cover for contact details).

When contacting your dealer or Miele, please quote the model and serial number of your machine, both of which are shown on the data plate visible above the door glass when the door is open.

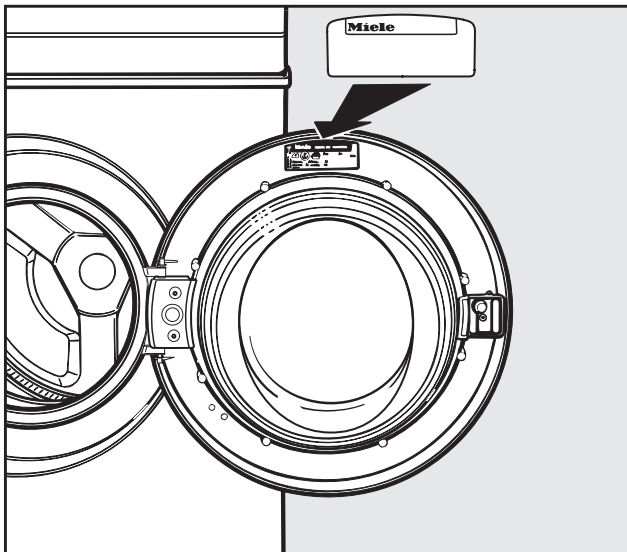

N.B. A call-out charge will be applied for unnecessary service visits where the problem could have been resolved by the customer as described in these instructions.

Future updates (PC)

The indicator or check light marked PC is the interface used by Miele service technicians during servicing work for testing purposes and for updating the machine's programme data.

Guarantee

Please see the guarantee card supplied with your machine.

Optional accessories

Optional accessories for this washer-dryer are available from your Miele Dealer, the Miele Spare Parts Department or via the internet at www.miele-shop.com.

Please note that telephone calls may be monitored and recorded for training purposes.

Installation and connection

Front view

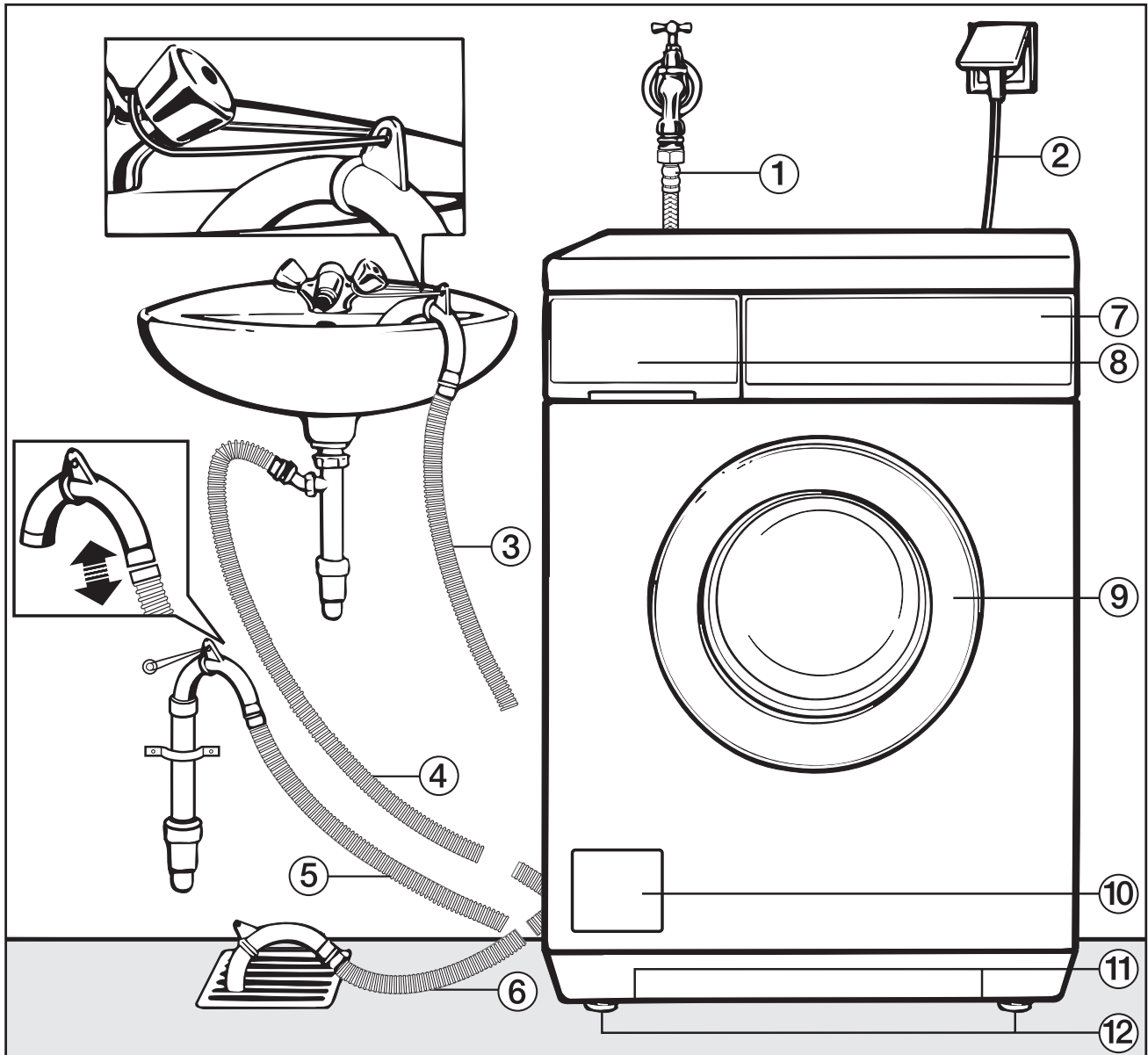

① Inlet hose (with flexible, waterproof metallic outer sleeve)

② Electricity supply cable

③ - ⑥ Flexible drain hose (with detachable swivel elbow)

⑦ Control panel

⑧ Detergent dispenser drawer

⑨ Drum door

⑩ Access to drain filter, drain pump and emergency release

⑪ Handle recesses for moving the machine

⑫ Four height adjustable feet

Rear view

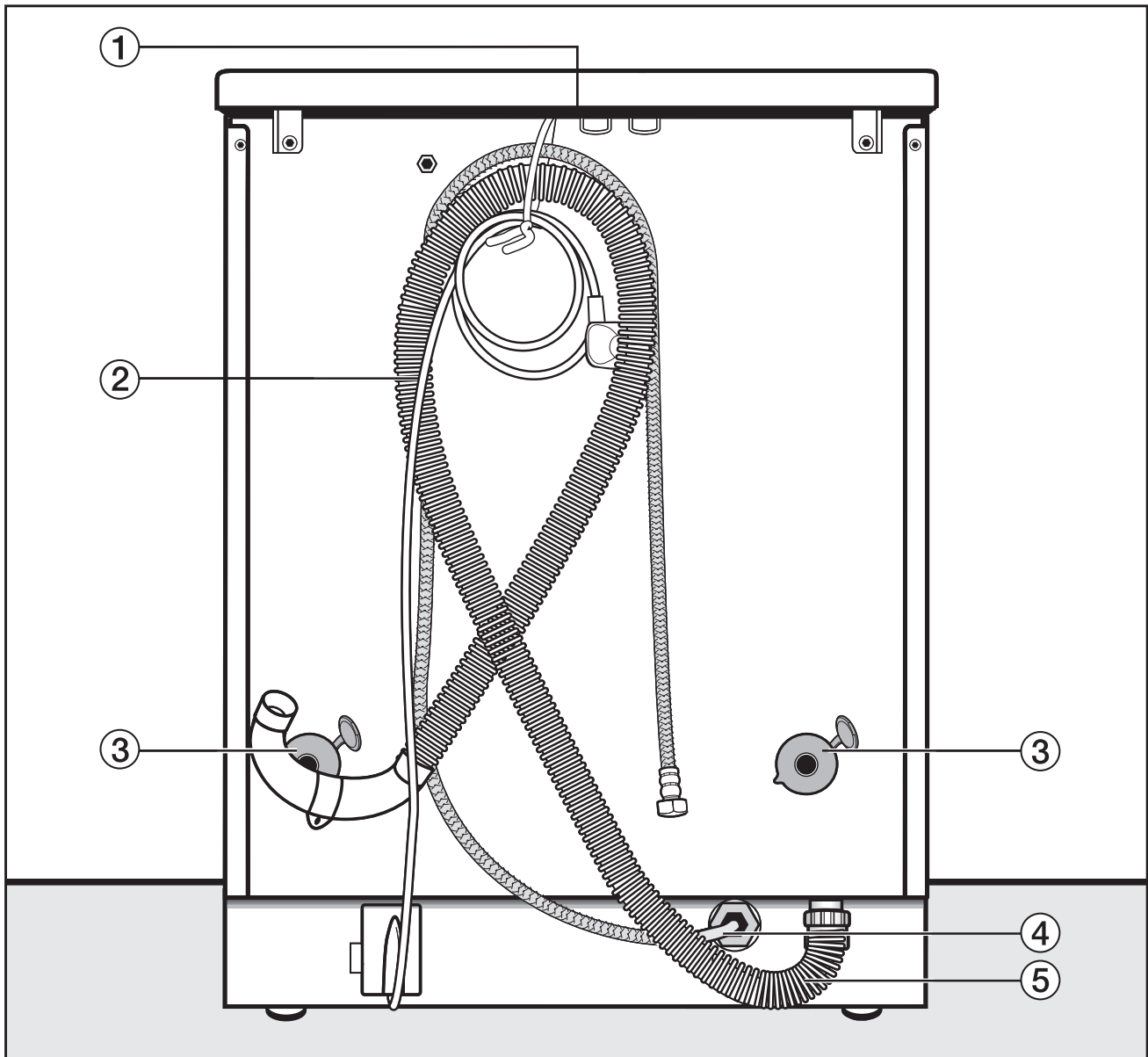

- ① Protruding lid for holding when moving the machine
- ② Electricity supply cable
- ③ Transit bar covers
- ④ Inlet hose (with flexible, waterproof metallic outer sleeve)
- ⑤ Drain hose

Installation and connection

Installation surface

A concrete floor is the most suitable installation surface, being far less prone to vibration during the spin cycle than wooden floorboards or a carpeted surface.

Please note the following points:

- The machine must be level and securely positioned.
- To avoid vibrations during spinning, the machine should not be installed on soft floor coverings.

If installing on a wooden joist floor:

- We recommend a plywood base (at least 59x52x3 cm) The base should span several joists and be bolted to the joists and not only to the floorboards. Check for the presence of pipes and cables first.

If possible, install the machine in a corner, as this is usually the most stable part of the floor.

⚠ If the machine is installed on a raised plinth, it **has to be secured** against slippage during spinning using retaining clips (available from the Miele Spare Parts Dept). Otherwise there is a danger of the washer-dryer moving about and falling off the plinth.

Installing the washer-dryer

To manoeuvre the machine out of its packing case to its installation site, hold it by the edge of the lid where it protrudes to the rear of the machine as well as by the handle recesses at the front.

⚠ Ensure that the machine feet and the floor are dry to prevent the machine from slipping during the spin cycle.

Removing the transit bars

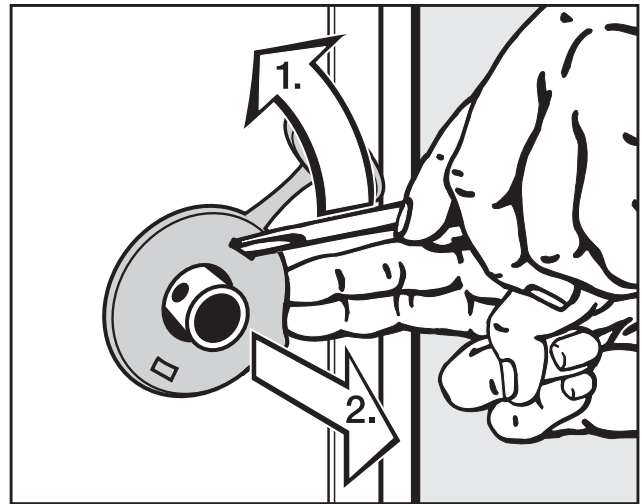

- To remove the left and right covers
 1. Use a screwdriver to prise out the cover as illustrated.
 2. Pull the cover forwards to remove.

Installation and connection

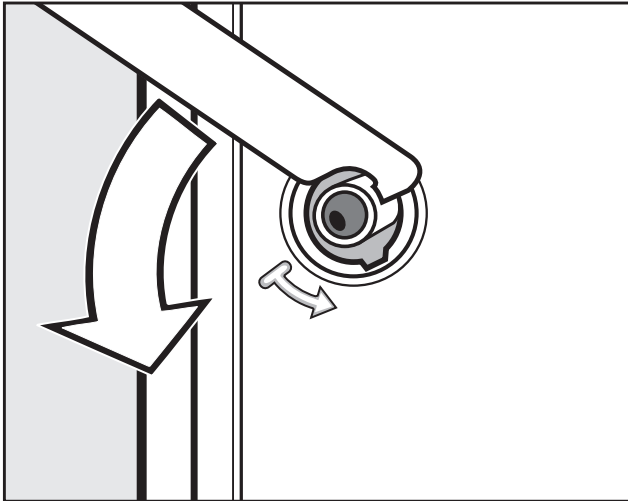

- Using the spanner supplied turn the left-hand transit bar 90°, then

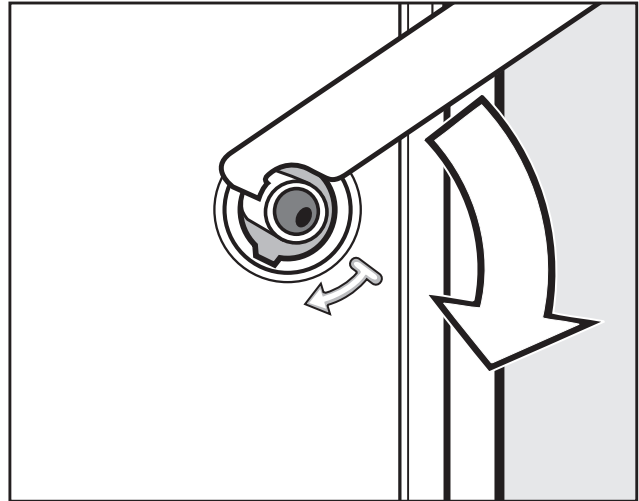

- Turn the right-hand transit bar 90°, then

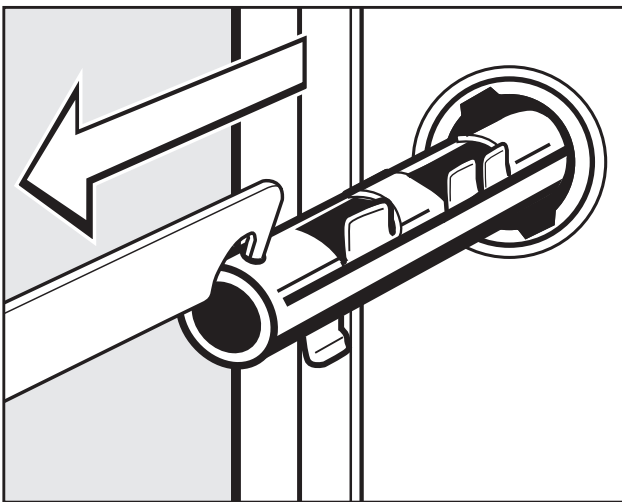

- withdraw the transit bar.

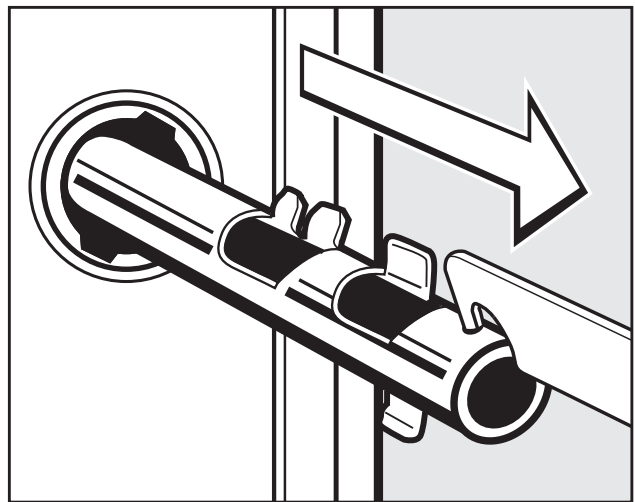

- withdraw the transit bar.

Installation and connection

 To avoid the risk of injury the holes for the transit bars must be covered after the transit bars have been removed.

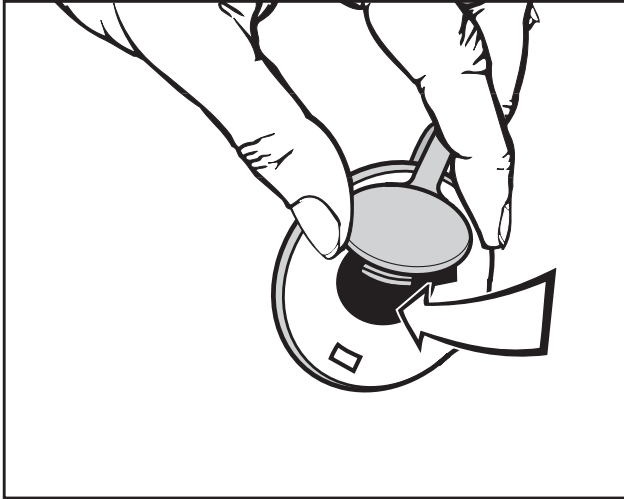

- Fit the covers on to the two holes. Then plug the holes as shown with the caps.

 The machine must not be moved without the transit bars in place. Store them in a safe place for future use. They must be re-fitted if the machine is to be moved again (e.g. when moving house).

Re-fitting the transit bars

Re-fitting is carried out by reversing the procedure.

Levelling the machine

The machine must stand perfectly level on all four feet to ensure safe and proper operation.

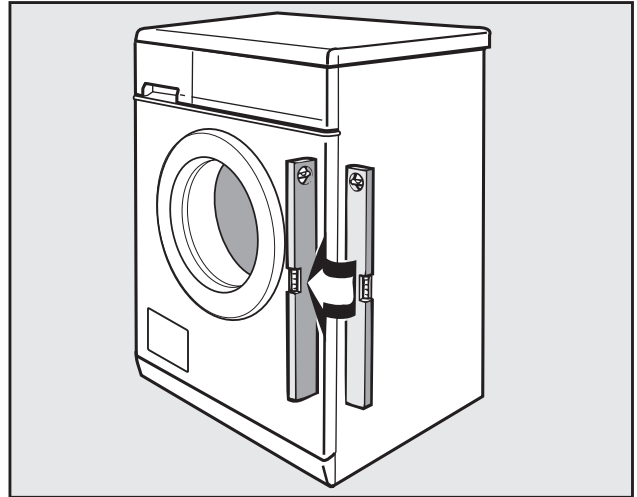

Incorrect installation may increase electricity and water consumption and may cause the washer-dryer to move about. False values may also show in the Load and Detergent display.

Screwing out and adjusting the feet

The four adjustable screw feet are used to level the machine. All four feet are screwed in when the machine is delivered.

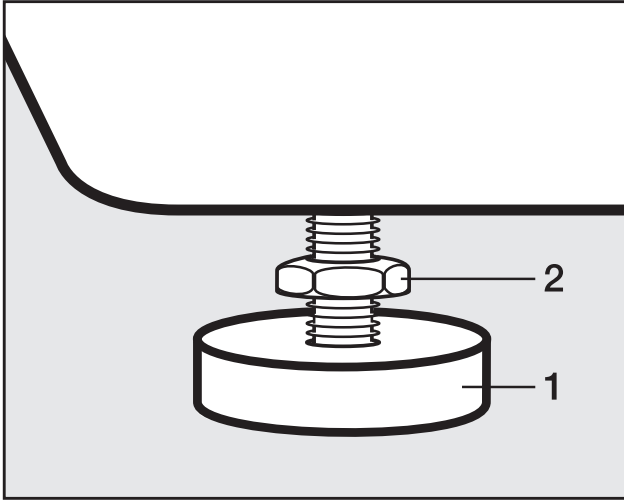

- Using the spanner supplied turn counter nut **2** in a clockwise direction. Then turn counter nut **2** together with foot **1** to unscrew.
- Use a spirit level to check the machine is standing level.
- Hold foot **1** securely with a pipe wrench. Turn counter nut **2** again using the spanner supplied until it sits firmly up against the housing.

⚠ All four counternuts must sit firmly up against the housing. Please also check this for the feet which did not need adjustment. Otherwise there is the danger of the machine moving about.

Building under a continuous worktop / in a kitchen run

The fitting of building under kits must only be undertaken by qualified and competent persons, in accordance with the instructions supplied with the kit.

If you wish to push your machine under a worktop and there is space to do this **without removing the lid**, the conversion kit is not necessary. Otherwise it is essential.

- The building under conversion kit* includes a cover plate which must be fitted to ensure electrical safety.
- When installing under a 900/910 mm high worktop a raising kit* is required.
- Connections for electricity, water and drainage should be installed in such a way that they remain accessible when the machine is in place.

Fitting instructions are supplied with the conversion kit.

All parts marked * are available from your Dealer, the Miele Spare Parts Department or via the internet at www.miele-shop.com.

Installation and connection

The Miele water protection system

The Miele water protection system protects machine from water damage.

The system consists of three main components:

- 1) the inlet hose
- 2) the electronic unit and the machine housing
- 3) the drain hose

1) Inlet hose

- The inlet hose is tested to withstand pressure of more than 14,000 kPa.
- It has a protective sleeve which is made from metal to protect the hose from damage.

2) Electronic unit and machine housing

- Sump

Any leaking water is collected in a sump in the base of the machine. A float switches off the safety valves, preventing any more water flowing into the machine and water in the suds container is pumped away.

- Overflow protection

This prevents the machine taking in too much water. If the water level exceeds a certain level, the drain pump switches in and pumps the excess water away.

3) Drain hose

The drain hose is protected by a ventilation system which prevents the machine from being emptied completely.

Connection to the water supply

The machine should be connected to a mains water supply in accordance with local and national safety regulations. The German authorities do not require it to have a non-return valve as the washer-dryer has been designed to comply with DIN regulations.

The machine is designed to operate with a flow pressure of between 100 kPa and 1,000 kPa. If it is higher than 1,000 kPa it is essential to fit a reducer valve.

Connection to the mains water supply should incorporate a mains stopcock with $\frac{3}{4}$ " thread. The stopcock should be fitted by a qualified plumber.

 The connection point is subject to mains water pressure. Turn on the stopcock slowly and check for leaks. Correct the position of the washer and union if appropriate.

This machine is **not** suitable for connection to a hot water supply.

Maintenance and care

Only use a genuine Miele hose which is pressure tested to 14,000 kPa should you ever need a replacement or extension.

In order to protect the water inlet valve, the dirt filter in the water inlet valve connection must not be removed.

Extension hose

A 1.5 metre long (metal) extension hose is available from your Miele dealer or the Miele Spare Parts Department as an optional extra.

This hose is tested to withstand pressures of up to 14,000 kPa and can be used as a flexible extension to the water supply.

Installation and connection

Connection to the drainage system

The machine drains via a drain pump with a delivery head of 1 metre*. The drain hose must not be kinked as this restricts drainage. The swivel elbow at the end of the hose can be turned in either direction, or can be detached if required, with a sharp twist and pull.

* For a delivery head of more than 1 m (up to a max. of 1.8 m) a second duo-drain pump is available with the corresponding kit from the Miele Spare Parts Department or your Miele Dealer.

Drain hose connection:

1. Direct into a sink or basin:

Please note:

- Hook the hose over the edge and secure.
- Make sure that the water can drain away freely without hindrance. Otherwise there is a risk of water overflowing or of some of the drained water being siphoned back into the machine.

2. Connected securely to a plastic drain pipe with a rubber nipple. There is no need to use a non-return valve.

3. Connected securely to a standpipe.

4. Connected securely to a floor gully.

If required, the drain hose can be extended to a length of 5 m. The necessary parts can be purchased from the Miele Spare Parts Department or your Miele dealer.

Electrical connection U.K.

All electrical work should be carried out by a suitably qualified and competent person, in strict accordance with current national and local safety regulations (BS 7671 in the UK).

Ensure power is not supplied to the appliance until after installation work has been carried out.

The appliance is supplied with a mains cable with moulded plug ready for connection to a 230-240V mains supply.

Please ensure the connection data quoted on the data plate match the household mains supply.

Connection should be made via a suitable switched socket which is easily accessible after installation.

For extra safety it is advisable to protect the appliance with a suitable residual current device (RCD). Contact a qualified electrician for advice.

Do not connect via an extension lead. Extension leads do not guarantee the required safety of the appliance (e.g. danger of overheating).



Non-rewireable plugs BS 1363

The fuse cover must be refitted when changing the fuse, and if the fuse cover is lost, the plug must not be used until a suitable replacement is obtained. The colour of the correct replacement cover is that of the coloured insert in the base of the plug, or the colour that is embossed in words on the base of the plug (as applicable to the design of plug fitted).

Replacement fuses should be ASTA approved to BS 1362 and have the correct rating. Replacement fuses and fuse covers may be purchased from your local electrical supplier.

WARNING: THIS APPLIANCE MUST BE EARTHED

Consumption data

		Load	Consumption data			
			Energy in kWh	Water in litres	Duration	
				Short	Normal	
Washing						
Cottons	95°C	5.5 kg	1.75	45		2 h 19 min
	60°C ¹⁾	5.5 kg	0.85	45		2 h 39 min
	60°C	3.0 kg	0.63	39	1 h 29 min	
	40°C ¹⁾	5.5 kg	0.65	57		2 h 19 min
	40°C ¹⁾	3.0 kg	0.48	39	1 h 10 min	
Minimum iron	40°C ¹⁾	3.0 kg	0.48	50	1 h 06 min	1 h 31 min
Delicates	30°C	1.5 kg	0.33	65	49 min	59 min
Automatic plus	40°C	4.5 kg	0.50	55	–	1 h 27 min
Express 20	40°C	3.0 kg	0.30	26	20 min	
Woolens 	30°C	2.0 kg	0.23	39	–	39 min
Silks 	30°C	1.0 kg	0.25	39	–	36 min
Drying						
Cottons	Normal ²⁾	3.0 kg	1.77	13	–	1 h 28 min
Minimum iron	Normal ²⁾	1.5 kg	0.75	6	–	39 min
Washing and Drying						
Cottons	60°C Normal ³⁾	5.5 kg + 2x2.75 kg	3.70	69	–	5 h 20 min
Cottons	60°C Normal	3.0 kg + 3.0 kg	2.40	52	–	3 h 24 min

Notes for test institutes:

- 1) Test programme EN 60456 for test institutes; the *Short* extra option must be selected for the Short programme.
- 2) EN 61121 test programme
- 3) EN 50229 test programme

Consumption data can vary from the nominal values given depending on water pressure, water hardness, water inlet temperature, room temperature, type and volume of load, fluctuations in the electricity supply and any extra options selected.

Technical data

Height	850 mm
Width	595 mm
Depth	580 mm
Depth with door open	975 mm
Height for building under	820 mm
Width for building under	600 mm
Depth for building under	600 mm
Weight	101 kg
Capacity - Washing	5.5 kg dry laundry
Capacity - Drying	3.0 kg dry laundry
Voltage	See data plate
Connected load	See data plate
Fuse rating	See data plate
Consumption data	See "Consumption data"
Minimum water flow pressure	100 kPa (1 bar)
Maximum water flow pressure	1000 kPa (10 bar)
Inlet hose length	1.60 m
Drain hose length	1.50 m
Mains connection cable length	1.60 m
Delivery head max.	1.00 m
Maximum drainage length	5.00 m
LEDs	Class 1
Test certificates awarded	See data plate

Settings menu

The Settings menu is used to alter the machine's electronics to suit changing requirements. Settings can be altered at any time.

To open the *Settings* menu

- Switch the machine on.
- Turn the programme selector to *Further programmes/Settings*.



- Confirm the selection of *Settings* by pressing the **OK** button.

To select an setting

- Use the ∇ and \wedge buttons to scroll through the settings until the one you want is highlighted and then confirm your choice by pressing the **OK** button.
- Select the option you want and confirm your selection.

A tick will appear beside the option to show that it has been set.

To close the *Settings* menu

- Select *Back* \leftarrow and press the **OK** button to confirm your choice.

Language \leftarrow

The display can be set to appear in one of several different languages.

You can select one of the languages displayed via the *Language* sub-menu.

The flag after the word *Language* acts as a guide to prevent a language which will not be understood from being set.

Buzzer

When the buzzer function has been activated, an audible tone sounds at the end of a programme or when Rinse hold is reached.

You can select one of two options or deactivate the buzzer.

Off (the machine is delivered with this option selected)

Normal

The buzzer sounds at a *normal* volume.

Loud

The buzzer sounds at a *loud* volume.

Time

Select either a 24 hour or 12 hour clock, and then set the current time of day.

Clock format

- Use the \vee or \wedge buttons to select the way you want the time to be displayed and confirm your choice with the **OK** button.

Set the time of day

- Set the hour with the \vee and \wedge buttons and confirm your setting by pressing the **OK** button. Then do the same to set the minutes.

Temperature unit

You can choose for the temperature to be displayed in $^{\circ}\text{C}/\text{Celsius}$ or $^{\circ}\text{F}/\text{Fahrenheit}$.

The machine is delivered with the $^{\circ}\text{C}$ option selected.

Brightness / Contrast

There are ten different display settings.

The machine is delivered with this option set at: level 5

The display brightness/contrast will change as soon as a different setting is chosen.

Standby display

To save energy, the display goes out and the indicator light for the *Start/Stop* button starts flashing slowly.

The display will always go out,

- if a programme is not selected within 10 minutes of the machine being switched on.
- 10 minutes after the end of a programme.

Pressing one of the buttons switches the display back on again.

You can also choose whether you want the display to go out 10 minutes after a programme has started or to remain visible throughout the programme.

On

Standby comes on: The display will go out 10 minutes after a programme has started.

Not in current prog. (the machine is delivered with this option selected)

Standby is switched off: The display will remain visible during a programme.

Keypad tone

An audible tone sounds each time a button is pressed.

The machine is delivered with this option set at: Off

Settings menu

Lock code

The code prevents the machine being used without your knowledge.

When the code has been activated, you have to enter a code after switching the machine on. Otherwise it cannot be operated.

To activate the lock code



- Select *Activate* and confirm your selection.

The display will now request that a code is entered. The code is **125** and cannot be altered.

Enter the lock code



- Use the \vee or \wedge buttons to change the first digit. Confirm your selection by pressing the **OK** button. Now enter the second digit.
- Repeat the process until all three digits have been entered and confirm your entry of the last one by pressing the **OK** button.

- Once the machine is switched off, it can only be used again if the lock code is entered.

The lock will now be activated when the machine is switched off.

To unlock the machine

When the machine is switched on again, the display will request the code.

- Enter code 125 as described above and confirm the entry.

The machine is now unlocked.

To deactivate the lock code

Proceed as for activating the lock code.

Memory

If an extra option has been selected for a programme, or the recommended spin speed has been altered, the machine will store the changes in memory at the start of a programme.

When this programme is chosen again these settings will appear in the display.

The machine is delivered with this option set at: Off

Longer pre-wash Cottons

The pre-wash duration can be extended in the Cottons programme.

If you require a longer pre-wash, an additional 6, 9 or 12 minutes can be added to the standard 25 minutes .

Gentle action

Activating gentle action reduces the drum action and is suitable for washing slightly soiled items more gently. It should be activated for garments with a single bar under the care label and for articles which feel too hard after they have been dried.

Gentle action can be activated for the *Cottons* and the *Minimum iron* programmes.

If Gentle action is programmed into the machine, every wash cycle in these programmes will be carried out with gentle action rhythm.

The machine is delivered with this option set at: Off

Suds cooling

When this is activated, additional water flows into the drum at the end of the main wash to cool the suds down. Hot suds can damage plastic drainage pipes.

Suds cooling takes place when temperatures of 95°C and 75°C are selected.

Suds cooling should be activated:

- to prevent the danger of scalding if the drain hose is hooked over the edge of a sink or basin.
- where the drainage pipes do not comply with DIN 1986.

The machine is delivered with this option set at: Off

Distribution controller

The maximum final spin speed is limited to prevent the laundry forming a ring against the drum. (This setting is only available when washing and drying in a continuous sequence).

There is a choice of 1200 rpm (default setting), 1100 rpm, 1000 rpm and 900 rpm.

Settings menu

Drying levels

The drying levels in the *Cottons* and *Minimum iron* programmes can be altered.

Select the required setting and then determine whether laundry should be damper or drier after drying.

Extended cool down

The cooling down phase which takes place before the end of a programme can be lengthened if required. This makes the garments easier to handle.

The cooling down phase can be lengthened from 0 min to 18 minutes.

- Set the duration with the ∇ and \wedge buttons and confirm your setting by pressing the **OK** button.

The programme duration will increase accordingly.

Anti-crease

Anti-crease helps prevent creasing if laundry is not normally removed immediately after the end of a programme.

The drum will turn at intervals for up to 30 minutes after the programme has finished. The door can be opened and laundry removed at any time during the anti-crease phase.

On: Anti-crease is activated (default setting).

Off: Anti-crease is deactivated.

Miele offer perfect care for your laundry with a wide range of special programmes designed to suit the fabrics being washed and dried. Miele have also developed a range of specialist CareCollection detergents and conditioning products to offer you a complete package for cleaning and caring for your laundry.

The Miele CareCollection detergents and conditioning products are listed below. You can order these and many other useful products via the internet at:



All the products can also be ordered from Miele. See back cover for contact details.

CareCollection

Miele specialist detergents

Outdoor wear

This specialist detergent will clean your water repellent outerwear with care.

Sportswear

The Miele Sportswear detergent is designed to clean sportswear whilst taking care of special microfibres used in these garments. It will help to neutralise and remove odours whilst protecting the colour of the fabric and preventing static build up.

Down Items

This special purpose detergent contains a mild tenside and has been specially formulated to keep down-filled items supple and to give them bounce.

Miele proofing agent

This special finishing agent reproofs garments against wind and water and provides a dirt-repellent finish whilst retaining elasticity and breathability.

Optional accessories

UltraWhite detergent

This multi-purpose powder detergent has excellent stain removal properties and is suitable for white and light coloured laundry as well as heavily soiled coloured items.

UltraColor detergent for coloured garments

This liquid detergent is particularly suitable for cleaning coloured and dark garments. The special formulation offers effective stain removal, even at low temperatures, while helping to prevent colour fade.

Liquid detergent for Delicates

This liquid detergent is ideal for the gentle treatment of delicate fabrics, such as wool and silk. Its special formulation cleans effectively at temperatures as low as 20°C, while protecting the colour of your delicate garments.

Fabric conditioner

The Miele fabric conditioner will give your laundry a fresh, natural fragrance. It makes garments soft to handle and prevents static cling during tumble drying.

United Kingdom

Miele Co. Ltd.
Fairacres, Marcham Road
Abingdon, Oxon, OX14 1TW
Tel: 0845 365 0555, Fax: 0845 365 0777
Customer Contact Centre Tel: 0845 365 6600
E-mail: info@miele.co.uk
Internet: www.miele.co.uk

Australia

Miele Australia Pty. Ltd.
ABN 96 005 635 398
1 Gilbert Park Drive, Knoxfield, VIC 3180
Tel: 1300 464 353, Fax: (03) 9764 7149
Internet: www.miele.com.au

China

Miele (Shanghai) Trading Ltd.
1-3 Floor, No. 82 Shi Men Yi Road
Jing' an District
200040 Shanghai, PRC
Tel: +86 21 6157 3500, Fax: +86 21 6157 3511
E-mail: mieleshanghai@cn.miele.com
Internet: www.miele.cn

Miele (Hong Kong) Limited

41/F - 4101, Manhattan Place
23 Wang Tai Road
Kowloon Bay
Hong Kong
Tel: (852) 2610 1331, Fax: (852) 2610 1013
Email: mielehk@miele.com.hk

India

Miele India Pvt. Ltd.
Ground Floor, Copia Corporate Suites
Plot No. 9, Jasola
New Delhi – 110025
Tel: 011-46 900 000, Fax: 011-46 900 001
E-mail: customercare@miele.in, Internet: www.miele.in

Ireland

Miele Ireland Ltd.
2024 Bianconi Avenue
Citywest Business Campus, Dublin 24
Tel: (01) 461 07 10, Fax: (01) 461 07 97
E-Mail: info@miele.ie, Internet: www.miele.ie

Manufacturer: Miele & Cie. KG
Carl-Miele-Straße 29, 33332 Gütersloh, Germany

Miele

Malaysia

Miele Sdn Bhd
Suite 12-2, Level 12
Menara SapuraKencana Petroleum
Solaris Dutamas No. 1, Jalan Dutamas 1
50480 Kuala Lumpur, Malaysia
Phone: +603-6209-0288
Fax: +603-6205-3768

New Zealand

Miele New Zealand Limited
Unit L, 10-20 Sylvia Park Road
Mt. Wellington, 1060, Auckland, NZ
Tel: 0800 264 353, Fax: 0800 463 453
Internet: www.miele.co.nz

Singapore

Miele Southeast Asia
Miele Pte. Ltd.
163 Penang Road
04 - 02/03 Winsland House II
Singapore 238463
Tel: +65 6735 1191, Fax: +65 6735 1161
E-Mail: infosea@miele.com.sg
Internet: www.miele.sg

South Africa

Miele (Pty) Ltd
63 Peter Place, Bryanston 2194
P.O. Box 69434, Bryanston 2021
Tel: (011) 875 9000, Fax: (011) 875 9035
E-mail: info@miele.co.za
Internet: www.miele.co.za

United Arab Emirates

Miele Appliances Ltd.
P.O. Box 11 47 82
Gold & Diamond Park
Sheikh Zayed Road
Building 6 / Offices Nos. 6-214 to 6-220
Dubai
Tel: +971-4-341 84 44
Fax: +971-4-341 88 52
E-Mail: info@miele.ae, Internet: www.miele.ae

