

# FRIGIDAIRE®

**INSTRUCTIONS MANUAL**  
WASHING MACHINE

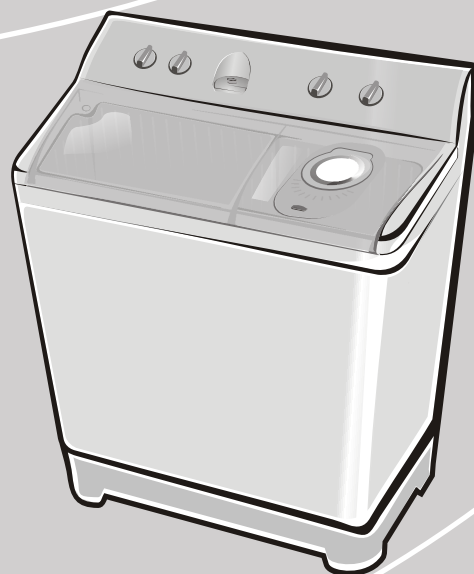

**Models:**

FWTE09M3FEJW  
FWTE09M3FEUJW  
FWTE09M1FEJW  
FWTE09M1FEUJW  
FWTE12M3FEJW  
FWTE12M3FEUJW  
FWTE12M1FEJW  
FWTE12M1FEUJW  
FWTE15M3FEJW  
FWTE15M3FEUJW  
FWTE15M1FEJW  
FWTE15M1FEUJW  
FWTE18M3FEJW  
FWTE18M3FEUJW  
FWTE18M1FEJW  
FWTE18M1FEUJW

W1310-3JFM\_English\_101201P(1)

# FRIGIDAIRE®

Read all instructions prior to using  
appliance and keep this manual for future reference.

## Welcome to the world of simple handling and no worries.

Thank you for choosing Frigidaire for your washing machine brand. Our washing machines are developed with high technical and quality standards, with features to offer you even more comfort.

Read all instructions before using this appliance. This book contains valuable information about operation, care and service. Keep it in a safe place.

You expect all this from Frigidaire...and we deliver.

Your laundry never looked so good.

## Environmental advices

This product can not be treated as household waste. Instead shall be handed over to the applicable collection point for the recycling of electrical and electronic equipment. By ensuring this product is disposed of correctly, you will help prevent potential negative consequences for the environment and human health, which could otherwise be caused by inappropriate waste handling of this product. For more detail information about recycling of this product, please contact your local city office, your household waste disposal service or the shop where you purchased the product.



## Contents

Safety.....	03
Washer description.....	04
Installation.....	05
Operation.....	10
Cleaning and maintenance.....	14
Tips and advices.....	16
Troubleshooting.....	20
Wiring diagram.....	21
Technical information.....	22

### **Attention**

The washing machine you bought might be different from the one shown on the figures of this user manual, however the overview image should be similar. Please read the information regarding to operation.

This washing machine is for household use only.

The washing machine you bought might have a different plug from the one shown on the figures of this user manual, however the one you bought is according to your country requirements.

## Safety

### Children

Avoid accidents, after removing washer from its packing, keep packing material out of children's reach.

Do not let children play with or around and use the washer, even when it is turned off.

### User / Installer

Only plug the washing machine directly in the current if it is correctly grounded and with the certain voltage.

No connection of the grounding wire with the neutral wire, otherwise the cabinet will be charged, which is likely to cause the danger of electric shock.

The socket and the grounding wire must be installed by an electrician to prevent incorrect installation, and to guarantee a safe use of electricity.

Do not install the washer in high humidity areas or exposed to the weather.

Connect the plug firmly.

We do not recommend the use of an extension cord or adapter plug.

Unplug the washer before cleaning.

Never unplug washer by pulling on power cord. Use the plug.

All repairs and servicing must be performed by an authorized servicer

unless specifically recommended in this manual.

Do not fasten, twist or tie the power cord. Do not try to fix it. If it is damaged, request the visit of a professional technician. If the power cord is damaged, it should be replaced by the manufacturer, service technician or a qualified person to prevent any risk.

After placing the washing machine, check if it is not over the power cord.

It is dangerous to modify the specifications or characteristic of the washing machine.

Never place lit candles on the equipment as they may start fires.

Never place the washing machine on a carpet.

Be sure that the hose is connected and the water supply is turned on.

Never put your hands into the tub during operation. The clothes could entangle around your hands and cause an accident.

Don't handle the electric motor.

After using, unplug and remove the water hose inlet.

The hot water temperature should not exceed 50°C

Do not store gasoline, cleaning solvents, kerosene, cooking oils, waxes, etc on or near the washer. These substances give off vapors or

chemical reactions that could ignite or explode.

Do not use the machine when your hands and feet are wet to avoid electrical unloadings.

Please keep the plug clean for better performance.

Always read and follow fabric care product labels.

Do not place heavy or hot objects on top of the washer. They can damage the finish or controls.

Get away from fire and heat: Never place candles, insect repellents, incense, cigars or other flammable vapors or liquids, electric ovens, heaters or other appliances that emit heat near the washer to avoid accidents or fire.

This washing machine is for domestic use only. It is not recommended for commercial or industrial use.

Do not wash laundries of paint and gasoline to avoid fire risk.

Do not block the air intake of the base while the washer is working.

## Washer description

### Name of parts

- |                 |                     |
|-----------------|---------------------|
| 1 Wash cover    | 8 Case              |
| 2 Control panel | 9 Pulsator          |
| 3 Spin cover    | 10 Plug             |
| 4 Frame         | 11 Base             |
| 5 Spin tub      | 12 Safety cover     |
| 6 Lint filter   | 13 Water inlet hose |
| 7 Wash tub      |                     |

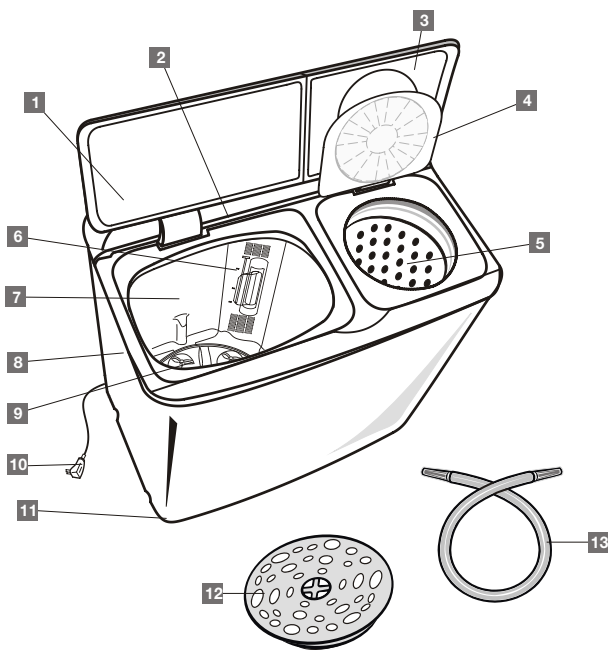

## Installation

The installation must be carried out by authorized people and in agreement with the instructions indicated by the manufacturer. Incorrect installation could cause personal damages.

### Location of washer

The washing machine should be placed inside the room with a flat floor, which is convenient for water supply and drain, has low moisture and no direct sunshine, and does not freeze in winter.

### Attention

1. If the washing machine is not placed flat (the inclination angle is over 2°), it may cause great vibration or automatic check and rectification or other abnormal circumstances will often take place in the course of spinning.
2. Never place the washing machine on a carpet.
3. Get away from fire and heat.

### Unpack

Take the washing machine to the place to be installed and unpacked it. All the material of the packing, including the foam of the base must be retired, if not the washing machine will not work.

### Installation of water inlet pipe

1. Put the water inlet pipe screw on to the tap.
2. Tightly screw another end of water inlet hose on water inlet valve.

### Installation of drain hose

1. Without pump: The hose should be less than 10cm, or it can not drain completely.

2. With pump: Hang the drain hose (with hook) over a drain outlet (a drain pipe, bath or sink) not higher 1.2 metres above floor level (up drain).

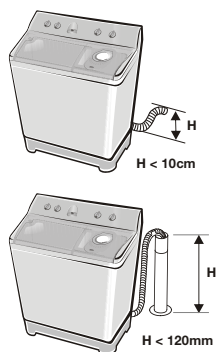

### Change the direction of the drain hose

The factory installation position of the drain hose is shown in Figure 1.

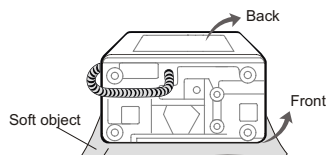

Figure 1

The hose protrudes out from washing side. Lay down the machine on the soft object with its face towards the ground. Take the hose out from the fixing groove. (Figure 2).

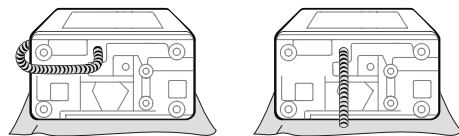

Figure 2

Along with the groove of the washing tub side, insert the hose with the step 1 to 3 and spread it to the washing side (Figure 3)

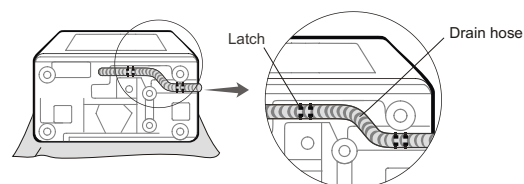

Figure 3

Insert the hose in the groove by hand, do not destroy the hose.

### Attention

It had better put the outlet of the drain hose into the nearby drainage permanently, which can save the trouble that the drain hose has to be connected each time before use. If the drainage is far from the washing machine, it can be solved by connection of the drain hoses head with end to extend.

Drain faults will be caused when the drain hose is blocked.  
No trampling on or pressing the hose.

### Power source and grounding

1. Consult the technical specification chart to verify the distribution's network voltage.
2. The socket and the grounding wire must be installed by an electrician to prevent incorrect installation or use of the socket, and to guarantee the safety of use of electricity.
3. No connection of the grounding wire with the neutral wire, otherwise the cabinet will be charged, which is likely to cause the danger of electric shock.
4. Do not fasten, twist or tie the power cord. Do not try to fix it. If it is

damaged, request the visit of a professional technician. If the power cord is damaged, it should be replaced by the manufacturer, service technician or a qualified person to prevent any risk.

5. It is dangerous to modify the specifications or characteristic of the washing machine.
6. Save practices for energy usage: Please connect the plug to the dedicated outlet. Whenever you have to connect or disconnect the unit, always do it by holding the cable by the plug and not by the cable.
7. Please do not pull out or insert the plug with wet hands to avoid electric shocking.
8. Please keep the plug clean for better performance.
9. Please disconnect the unit from the power supply if it is not in use.

## Operation

### Control panel

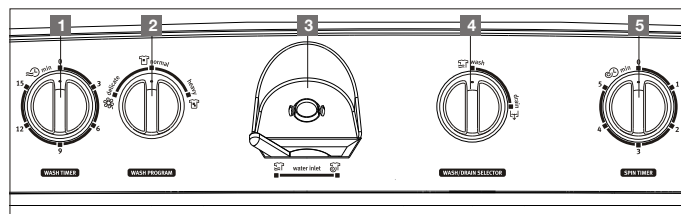

- |                              |                              |
|------------------------------|------------------------------|
| <b>1</b> Wash timer selector | <b>4</b> Spin selector       |
| <b>2</b> Wash selector       | <b>5</b> Spin timer selector |
| <b>3</b> Washing water inlet |                              |

### Precaution to washing

01. Put the drain hose down into the water drain area.
02. Insert the water inlet hose securely into the top water inlet.
03. Checking pocket of clothes to avoid coins, clips and etc.
04. Reversing the clothes that are easy teaseled.
05. To resist clothes 's crossing, please cross their sleeves or the ties in advance.
06. Separating clothes if they are easily fading color.
07. Separate clothes by color, dirty degree and fabric type.
08. To put delicate clothes into washing net bag.
09. Zipping the clothes if they have in advance.
10. The laundry should be able to circulate enough in the washing tub.

### Attention

The illustrations in this manual are for reference only. The product that you have bought may be slightly different from the one illustrated in this manual. Please refer to the information related to the model you have

Control panel is based on a typical model, the function should be the same on your washers, even if the appearance is a little different.

### How to use the bleacher

1. Fill the water to the specified level, and pour the bleacher into wash tub.
2. The colourful clothes are apt to fade, so the bleacher is forbidden to use.
3. The bleacher should not contact with clothes directly.
4. The use of bleacher, refers to its instruction.
5. The powder bleacher can be used after dissolved.

### How to use washing powder

#### Detergent consumption

1. Generally 1.4g per liter of water, more or less consumption accordingly for different detergent.

#### Dissolved in the tub

1. Fill small quantity of water.
2. Add some washing powder run for 30 seconds to dissolve it completely.
3. Put the clothes in and select the proper water level.

#### Quick dissolving

1. Put the clothes in and select the proper water level.
2. Put the powder in and stir.

### Attention

The powder is more prone to pollute the clothes than the detergent, therefore please use it with proper quantity.

### Washing instructions

1. Put the water inlet hose into the wash inlet.
2. Fill the water to the specified level and add dissolved washing powder.
3. Put in the clothes, please add the water if the water is not enough.
4. Select the program according to clothes.
5. Select the wash time according to clothes.
6. After washing, set the "Washing-drain selector" to "drain" position to empty the water.

### Midway spinning

1. Put the clothes in spin tub smoothly.
2. Spin.
  - a) Press the safety cover properly. Even though a few clothes, press the cover too.
  - b) Close the spin cover.
  - c) Spin for 1 ~ 2 minutes.
3. Rinse and foam-removing spinning
  - a) Open the spin cover.
  - b) Put the inlet hose into the spin inlet and fill water for 1 minute.
  - c) Close the cover, spin for 1 ~ 2 minutes.

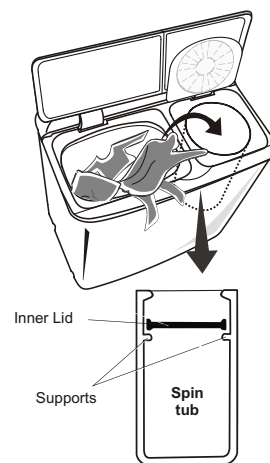

Spin Time				
Spin Time	4-5 min.	2- 4 min.	1 - 2 min.	1 min.
Clothes	Bedsheet, blanket	Underwear (knitwear)	Sweater(fabric)	Thin clothes

### Attention

To do spinning and draining or rinsing (filling water) together, please first do spinning for about 1 minute, then do draining or rinsing, otherwise the spinning will stop owing to too much water stored in the spin tub.  
Despues de usar la maquina, desconéctela y saque la manguera de flujo de agua.

#### Rinse (filling water)

1. Put clothes in the wash tub and select the suitable water flow according to the clothes.
2. Adjust the wash timer to 5-7minutes to do rinsing.

#### Rinse with water (Repeat the midway spinning and rinse for 2-3 times)

1. Put clothes in the washing tub and select the suitable water flow according to the clothes.
2. Fill water to the specified level.

## Cleaning and maintenance

#### Internal parts

Once a month, pour a liter of bleach (chlorinated water) into drum. Select high water level "Normal" program. Let the Washing Machine complete wash cycle to guarantee total removal of bleach.

Cleaning must be performed to prevent stains on clothes, due to accumulation of fabric softener and soap residue.

#### Cabinet care

To clean the cabinet off the water and dirt with soft cloth, no detergent, volatile and other chemicals used to avoid surface destroying.

#### Cleaning the lint filter

1. While pressing down on the button, pull the lint filter out.
2. Turn the filter net inside out and rinse with water.
3. After cleaning, insert edge of filter into the notch and push the filter into place while pressing the button down.

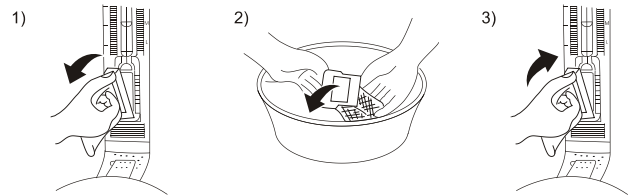

#### Cleaning dirty drain valve

1. Take off the overflow filter cover, loose the belt and screw off the valve cover in counter-clockwise, to take valve rod and other parts out then remove dirt inside.
2. Reverse the above steps to make all parts reverting.



### Freezing prevention

1. Turn off the water faucet, pull off the inlet hose and empty all water from the inlet hose.
2. Put down drain hose and switch the indicator to "drain" position to empty all water from wash tub.

### If freezing happens to

1. Put the inlet hose in warm water of 50°C.
2. Have about 2 liter of warm water less than 50°C into the wash tub for 10 minutes.
3. Install inlet hose and turn on the water faucet to ensure inlet and outlet of

### How to clean dirty pump (only for models with pump)

1. Take off the back cover off the washer, press the clip at the drain hole of pump, and pull out the drain hose.
2. Clean the pump from the drain hole of pump.

## Tips and advices

White and color clothes must be washed separately to prevent transferring dye from one item to another.

To check if a piece of clothing fades, soak a small area.

Place a white cloth over it and iron. If the white cloth stains, the fabric will fade.

Check clothing label to make sure it can be machine-washed.

Follow instructions on label.

Woolen items must always be washed separately, in cold water.

Do not use bleach in woolen clothes, silk, leather and Lycra, spandex.

Wash separately cotton and linen clothes from synthetic fabric (nylon, spandex, polyamide, etc...), as they require different washing process.

Do not use dry cleaning chemical products in your Washer.

Do not use Washer to starch clothes.

### Stain removal

Adhesive tape, chewing gum, rubber cement: Apply ice. Scrape off excess. Place stain face down on paper towels. Saturate with prewash stain remover or nonflammable dry deaning fluid.

Baby formula, dairy products, egg: Use product containing enzymes to pretreat or soak stains. Soak for 30 minutes or more. Wash.

Blood: Rinse with cold water. Rub

with bar soap. Or, pretreat or soak with product containing enzymes. Wash using bleach safe for fabric.

Candle wax, crayon: Scrape off surface wax. Place stain face down between paper towels. Press with warm iron until wax is absorbed. Replace paper towels frequently. Treat remaining stain with prewash stain remover or nonflammable dry cleaning fluid. Hand wash to remove solvent. Wash using bleach safe for fabric.

Chocolate: Pretreat or soak in warm water using product containing enzymes. Wash using bleach safe for fabric.

Collar or cuff soil, cosmetics: Use packaged color remover. Wash using bleach safe for fabric.

Grass: Pretreat or soak in warm water using product containing enzymes. Wash using bleach safe for fabric.

Grease, oil, tar (butter, fats, salad dressing, cooking oils, car grease, motor oils): Scrape residue from fabric. Pretreat. Wash using hottest water safe for fabric. For heavy satins and tar, apply nonflammable dry cleaning fluid to back of stain. Replace towels under stain frequently. Rinse thoroughly. Wash using hottest water safe for fabric.

Ink: Some inks may be impossible to remove. Washing may set some inks. Use prewash stain remover, denatured alcohol or nonflammable dry deaning fluid.

**Mildew, scorch:** Wash with chloirine bleach if safe for fabric. Or soak in oxygen bleach and hot water before washing. Badly mildewed fabrics may be permanently damaged.

**Mud:** Brush off dry mud. Pretreat or soak with product containing enzymes.

**Mustard, tomato:** Pretreat with prewash stain remover. Wash using bleach safe for fabric.

**Nail polish:** May be impossible to remove. Place stain face down on paper towels. Apply nail polish remover to back of stain. Repeat, replacing paper towels frequently. Do not use on acetate fabrics.

**Paint, varnish:**

*a) Water based:* Rinse fabric in cool water while stain is wet. Wash. Once paint is dry, it cannot be removed.

*b) Oil based and varnish:* Use solvent recommended on can label. Rinse thoroughly before washing.

**Perspiration:** Use prewash stain remover or rub with bar soap. Rinse. Wash using nonchlorine bleach in hottest water safe for fabric.

**Rust, Brown or yellow discoloration:** For spots, use rust remover safe for fabric. For discoloration of an entire load, use detergent and nonchlorine bleach. Do not use chlorine bleach because it may intensify discoloration.

**Shoe polish:**





*a) Liquid:* Pretreat with a paste of granular detergent and water.

*b) Paste:* Scrape residue from fabric. Pretreat with prewash stain remover or nonflammable dry cleaning fluid. Rinse. Rub detergent into dampened area. Wash using bleach safe for fabric.

**Urine, vomit, mucus, feces:** Pretreat or soak in product containing enzymes. Wash using bleach safe for fabric.

### International symbols

These symbols are included on clothing labels to help with your washing.

INTERNATIONAL SYMBOLS						
 Heavy	 Maximum Wash Temperature 95°C	 Maximum Wash Temperature 60°C	 Maximum Wash Temperature 40°C	 Maximum Wash Temperature 30°C	 Hand Wash	 Do not Wash
 Delicate	 Bleach		 Bleach in Cold Water		 Do not Bleach	
 Iron	 Maximum Iron Temperature 200°C	 Maximum Iron Temperature 150°C	 Maximum Iron Temperature 110°C	 Do not iron		
 Professional Dry Cleaning	 Professional Dry Cleaning with Any Solvent	 Professional Dry Cleaning with Specific Solvent	 Professional Dry Cleaning with Specific Solvent	 Do not Dry Clean		
 Dry	 Dry Flat	 Drip Dry	 Hang to Dry	 Do not Tumble Dry	Tumble Dry  High Temperature  Low Temperature	

### Clothes weight chart

To avoid water and energy waste, try to use the complete load size.

ITEM	WEIGHT (G)
Diaper	50
Underwear	50
Nightgown	100
T-shirt	100
Shirt	180
Pair of Jeans	800
Sweatshirt (adult)	700
Pajamas	400
Pillowcase	100
Sheet (single)	500
Sheet (double)	700
Bedsread (single)	1.000
Bedsread (double)	1.300
Hand Towel	150
Bath Towel	450
Tablecloth	500
Dishcloth	60
Duvet (single)	900
Duvet (double)	1.800

## Troubleshooting

If your washer does not work well, check the table below for probable cause and / or solutions.

If the problem cannot be solved call our Technical Service Center.

### If Washer does not work

Wash program dial is not set correctly	Position the dial at beginning of the mark of the selected
Power outage	Wait until it is restored.
Electric circuit (socket, wiring, breakers) in bad condition.	Check electric circuit and, if necessary, call an electrician.
"Washer timer" or "Spin timer" in "0" position.	Set the "Wash timer" or "Spin timer" to desired time.
An adaptor was used for the socket or extension.	Do not use adaptors. Change socket. Do not use extension cord.

### No draining

Disconnected hose.	Connect the hose.
Drain hose or inner pipe freezed.	Defrost the hose or the internal tubing.
Water outlet hose is pinched or doubled.	Fix hose or reposition it.

### Lint on Clothes

Clothes from different fabrics were washed together.	Select clothes according to wash program or according to tips.
--	--

### Stained Clothes

Too much soap and / or fabric softener.	Use recommended amount.
Water Supply is dirty.	Install filter on the faucet.
Washing Machine was not properly cleaned.	Clean Machine as recommended.

### Noises / Vibration

Washer not leveled.	Level the washer
Washing Machine is touching wall / piece of furniture.	Move Washer.
Clothes are not properly placed inside drum.	Place the items properly.
Coins or other sundries inside the wash tub.	Take the coins or other sundries inside the wash tub.

## Wiring diagram

### Models without pump

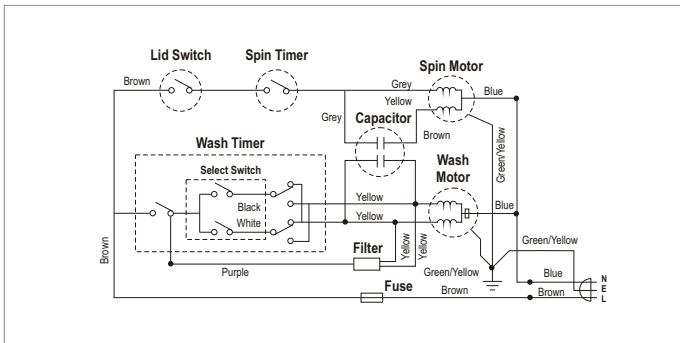

### Models with pump

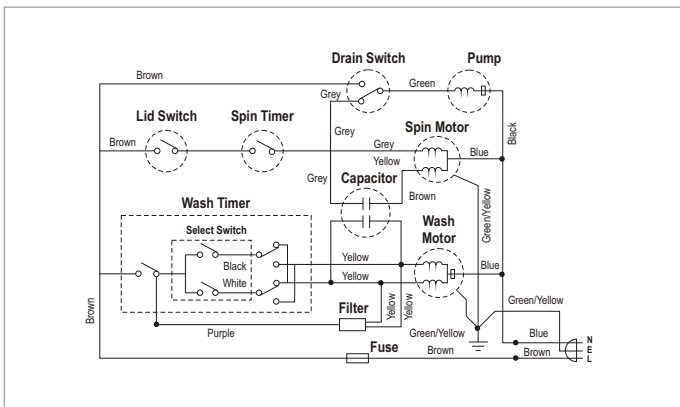

## Technical information

### Models without pump

	FWTE09M3FEUJW	FWTE09M1FEUJW
Capacity	9 kg	9 kg
Rated voltage	120V	110V
Rated frequency	60 Hz	50 Hz
Maximum input power	560 W	560 W
Wash power	400 W	400 W
Spin power	160 W	160 W
Pump power	--	--
Amount of water	70 L	70 L
Overall dimensions (WxHxD)	800x945x465 mm	800x945x465 mm
Net weight	25 kg	25 kg

	FWTE12M3FEUJW	FWTE12M1FEUJW
Capacity	12 kg	12 kg
Rated voltage	120V	110V
Rated frequency	60 Hz	50 Hz
Maximum input power	620 W	620 W
Wash power	460 W	460 W
Spin power	160 W	160 W
Pump power	--	--
Amount of water	80 L	80 L
Overall dimensions (WxHxD)	870x1010x500 mm	870x1010x500 mm
Net weight	29 kg	29 kg

	FWTE15M3FEUJW	FWTE15M1FEUJW
Capacity	15 kg	15 kg
Rated voltage	120V	110V
Rated frequency	60 Hz	50 Hz
Maximum input power	680 W	680 W
Wash power	500 W	500 W
Spin power	180 W	180 W
Pump power	--	--
Amount of water	95 L	95 L
Overall dimensions (WxHxD)	930x1010x540 mm	930x1010x540 mm
Net weight	31 kg	31 kg

	FWTE18M3FEJW	FWTE18M1FEJW
Capacity	18 kg	18 kg
Rated voltage	120V	110V
Rated frequency	60 Hz	50 Hz
Maximum input power	700 W	700 W
Wash power	500 W	500 W
Spin power	200 W	200 W
Pump power	--	--
Amount of water	105 L	105 L
Overall dimensions (WxHxD)	983x1050x560 mm	983x1050x560 mm
Net weight	34 kg	34 kg

#### Models with pump

	FWTE09M3FEJW	FWTE09M1FEJW
Capacity	9 kg	9 kg
Rated voltage	120V	110V
Rated frequency	60 Hz	50 Hz
Maximum input power	590 W	590 W
Wash power	400 W	400 W
Spin power	160 W	160 W
Pump power	30 W	30 W
Amount of water	70 L	70 L
Overall dimensions (WxHxD)	800x945x465 mm	800x945x465 mm
Net weight	25 kg	25 kg

	FWTE12M3FEJW	FWTE12M1FEJW
Capacity	12 kg	12 kg
Rated voltage	120V	110V
Rated frequency	60 Hz	50 Hz
Maximum input power	650 W	650 W
Wash power	460 W	460 W
Spin power	160 W	160 W
Pump power	30 W	30 W
Amount of water	80 L	80 L
Overall dimensions (WxHxD)	870x1010x500 mm	870x1010x500 mm
Net weight	29 kg	29 kg

21

	FWTE15M3FEJW	FWTE15M1FEJW
Capacity	15 kg	15 kg
Rated voltage	120V	110V
Rated frequency	60 Hz	50 Hz
Maximum input power	710 W	710 W
Wash power	500 W	500 W
Spin power	180 W	180 W
Pump power	30 W	30 W
Amount of water	95 L	95 L
Overall dimensions (WxHxD)	930x1010x540 mm	930x1010x540 mm
Net weight	31 kg	31 kg

	FWTE18M3FEJW	FWTE18M1FEJW
Capacity	18 kg	18 kg
Rated voltage	120V	110V
Rated frequency	60 Hz	50 Hz
Maximum input power	730 W	730 W
Wash power	500 W	500 W
Spin power	200 W	200 W
Pump power	30 W	30 W
Amount of water	105 L	105 L
Overall dimensions (WxHxD)	983x1050x560 mm	983x1050x560 mm
Net weight	34 kg	34 kg

22

Notes



23

Notes

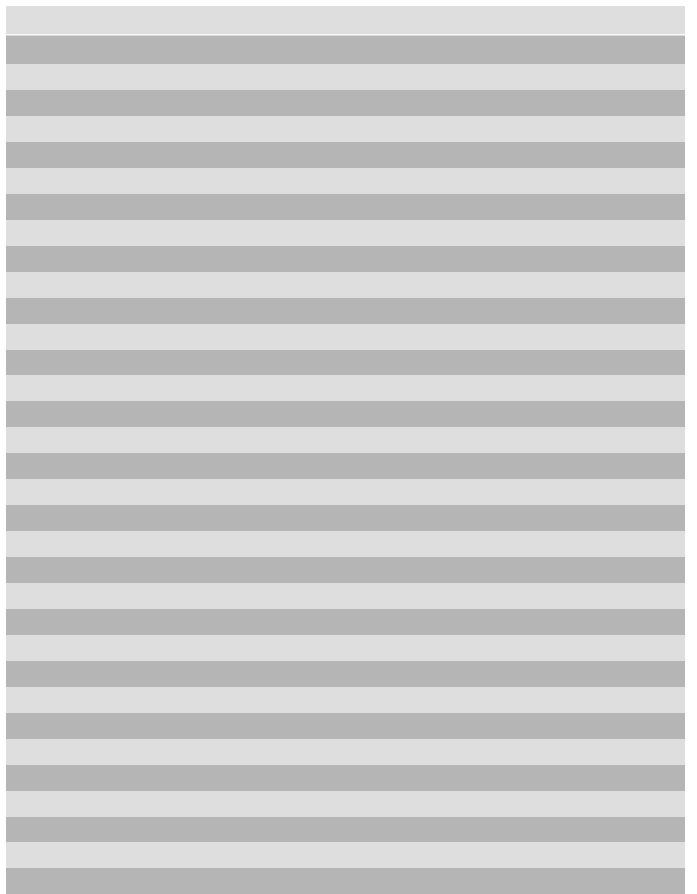

24